

Practical Computing

60p

July 1980

Volume 3 Issue 7



**Transam Tuscan—
the designer's
story**

**Reviews:
Sharp's pocket computer**

Inside the ZX-80

**Software review:
Payroll-200**

**Cheap hard copy
from teleprinters**

The best computers PLUS the best service

At MicroCentre, we're concentrating our resources on what we genuinely believe are the very best computers available today. . . . Cromemco computers, naturally. This way we can offer you the best deal possible.

What we don't do

What we don't do is spread our expertise thinly amongst umpteen different systems, or try to stock every S100 product on the market. We don't claim to offer "impartial" advice on the best buy. And we don't sell from price lists or catalogues.

The MicroCentre approach

Some micro-computer suppliers work like that, but we don't. Because we realise that when you're buying a computer you want more than the "brochures and boxes" approach. You want to see computers running; to try them out with different software products; to study the documentation; above all, you want expert answers to your most searching questions.

Cromemco specialists

That's why we've specialised in Cromemco systems. Not simply because we think Cromemco systems are the best serious computers available at the price.



MicroCentre's Cromemco demonstration room, with the full range of Cromemco computers, peripherals, operating systems and software products on permanent exhibition. Why not pay us a visit? We're only an hour's Shuttle flight from Heathrow!



Cromemco Model Z-2H hard disc computer. 10 megabyte hard disc, 2 floppy discs, Z-80 computer and 64K memory. MicroCentre price £5,326.

But because by doing so we can dedicate our time, energy and resources to giving you the highest standard of Cromemco support possible.

Demonstrations

So when you visit MicroCentre expect to find Cromemco systems on permanent

demonstration; expect the full range of Cromemco peripherals; single-user and multi-user systems; and interactive graphics.

Software

Expect a choice of operating systems and compilers to evaluate; expect complete documentation; and expect the largest collection of Cromemco systems software in the UK.

Expertise

Expect to find in-depth professional expertise at MicroCentre, the kind that is only acquired by installing Cromemco systems all over Britain. Expect a thorough appreciation of how Cromemco systems can be applied . . . in business, scientific research, industrial engineering, medicine and education.

Support

Expect to get frank, accurate answers to your questions at MicroCentre. Above all, once you've bought a Cromemco system from us, expect to get a very high standard of technical support with your hardware enhancements and continuing software needs.

At MicroCentre, simply expect the best.

For Cromemco... call the experts

NOW IN SPACIOUS
NEW SHOWROOMS

Tel. 031-556 7354

MicroCentre

STILL IN
CENTRAL EDINBURGH

Complete Micro Systems Ltd., 30 Dundas Street, Edinburgh EH3 6JN

● Circle No. 101



Transam Tuscan - the designer's story

Reviews:
Sharp's pocket computer
Inside the ZX-80
Software review:
Payroll-200
Cheap hard copy from teleprinters

The face that launched a thousand chips — Mike Hughes. The Transam Tuscan designer's story is on page 62.

Editor
Peter Laurie

Staff Writer
Duncan Scot

Production Editor
Toby Wolpe

Art
Margaret Smith

Editorial Secretary
Susie Manning

Advertisement Manager
Tom Moloney

Advertisement Executives
David Lake
Jeff Weinrich

Advertisement Secretary
Stephanie Hill

Consultants:
Technical **Nick Hampshire**
Software **Mike McDonald**
Videotex **Peter Sommer**

Publisher
Chris Hipwell

Editorial: 01-261 8752

Advertisements:
01-261 8000

Published by IPC Electrical Electronic Press Ltd, Dorset House, Stamford Street, London SE1 9LU, tel 01-261 8000, Telex/grams 25137 BISPRSG
Typesetting and artwork by Bow-Towning Ltd, London EC1
Printed by Eden Fisher Ltd, Southend-on-Sea

Distributed by IPC Sales and Distribution Ltd, 40 Bowling Green Lane, London EC1R 0NE

Subscriptions: U.K., £8 per annum; Overseas £14 per annum; airmail rates available on application to Subscription Manager, IPC Business Press (S & D) Ltd, Oakfield House, Perrymount Road, Haywards Heath, Sussex RH16 3DH, tel 0444 59188

© IPC Business Press Ltd 1980
ISSN 0141-5433

Would-be authors are welcome to send articles to the Editor but PC cannot undertake to return them. Payment is at £30 per published page. Programs intended for publication should ideally be justified to 22 or 44 or 66 characters per line.

Every effort is made to check articles and listings but PC cannot guarantee that programs will run and can accept no responsibility for any errors.

CONTENTS

- 41** Editorial / Software copyright and the law
- 42** Feedback / The ideal language; UK101 defended; delivery problems
- 46** Printout / Apple III in NCC Anaheim report; Winchester hard discs for U.K.; ZX-80 and MicroAce settlement
- 50** Payroll-200 / This month's software review features a payroll package for the Commodore 3032 assessed by Mike McDonald
- 54** Sharp PC-1211 / We examine the pocket computer from Sharp
- 58** Sinclair ZX-80 / A detailed look at the ZX-80
- 62** Tuscan designer's story / Mike Hughes tells the story behind the development of Transam's latest system
- 68** Call it a draw / Fiction by Michael Abbott
- 79** Videotex / Martin Hayman on the likely directions this new technology will take
- 80** Supertank / A war game by Bob Merry with a detailed explanation of how it was written and is played
- 86** Medicine / Duncan Scot takes the pulse of the medical software market and investigates applications for micros in medicine
- 89** CP/M / Why this piece of software occupies an important place in the world of computing by Peter Laurie
- 90** Robotics / The future of computer vision in robot-control systems analysed by Mark Witkowski
- 102** Applications / How computerisation has helped a supply and service agent
- 104** Cheap hard copy / Using the inexpensive Creed teleprinter, John Dawson explains how to obtain hard copy for the Nascom 1
- 109** Apple Pie
- 113** Pet Corner
- 117** Tandy Forum
- 119** 6502 Special
- 124** COS for Apple II / Part three of Hugh Dobb's series on a cassette operating system for Apple II
- 130** Hardware Buyers' Guide
- 184** Diary
- 185** Book reviews
- 186** Glossary / Continuing the terminological gamut from T to W
- Prestel page number 45631 / The Practical Computing Prestel pages

EXHIBITION GUIDE
AFTER 98

Sintrom Microshop

The S100 computer centre

Sintrom Periflex microcomputer with both 5" and 8" floppy disc drives

Vector Graphic microcomputers

Micropolis 5" floppy disc drives (now in stock)

Micropolis 8" Winchester / S100 systems

Telema computer systems

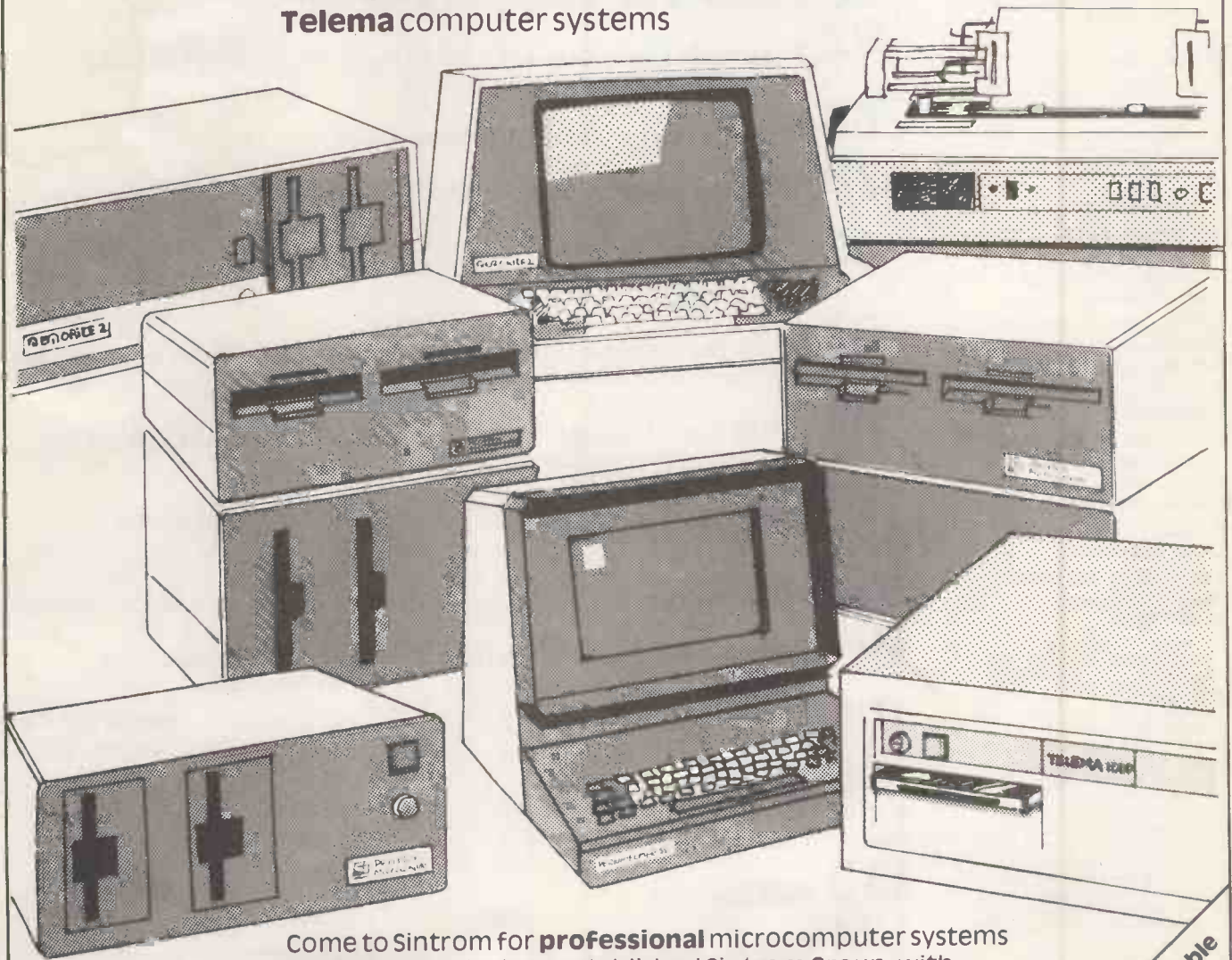

Come to Sintrom for **professional** microcomputer systems backed-up by the long established Sintrom Group, with years of experience in mini and micro computer systems and peripherals.



Sintrom Electronics

14 Arkwright Road, Reading, Berks RG2 0LS
Tel: Reading (0734) 85464 TELEX: 847395

Sintrom Microshop is a division of the Sintrom Group of Companies

Very competitive terms available for dealers and OEMs
Phone Martin Whittaker on (0734) 85464 for further details

Circle No. 102

The  Cromemco

Z-2H

THE
MARKET
LEADER

Z-2H
Computer System

 **Cromemco**

**11 Megabytes of hard disc storage in a fast,
new, table-top computer.**

- Fast Z80A 4MHz processor
- 11-megabyte hard disc drive
- Two floppy disc drives
- 64K RAM memory
- RS-232 serial interface
- Printer interface
- Extensive software available

Camberley	Microbits, Camberley, Surrey 0276 34044
Cambridge	Cambridge Computer Store, Cambridge 0223 68155
Dublin	Lendac Data Systems Ltd., Dublin 372052
Ilford	The Byte Shop, Ilford, Essex 01-554 2177 also at Tottenham Court Road, London 01-636 0647
Leeds	Holdene Ltd., Leeds 0532 459459 also at Wilmslow, Cheshire 0625 529486
London	Digitus Ltd., London W1 01-636 0105
Manchester	Computer Workshop, Manchester 061-832 2269 also at West Park, Leeds 0532 788466
Newbury	Newbear Computing Store, Newbury, Berks 0635 30505
Newport	Micromedia Systems, Newport, Gwent 0633 50528
Nottingham	Computerland Ltd., Nottingham 0602 40576 also at Birmingham 021-622 7149; Manchester 061-236 4737; Glasgow 041-332 2468
Sheffield	Hallam Computer Systems, Sheffield 0742 663125
Southampton	Xitan Systems Ltd., Southampton 0703 38740
St. Austell	Benchmark Computer Systems Ltd., St. Austell 0726 61000



comart specialists in microcomputers

Comart Ltd., P.O. Box 2, St. Neots, Huntingdon, Cambs, PE19 4NY. Tel: (0480) 215005 Telex: 32514

THE NEW DOLPHIN BD-80P

DEALER ENQUIRIES INVITED

NOT AVAILABLE EX STOCK

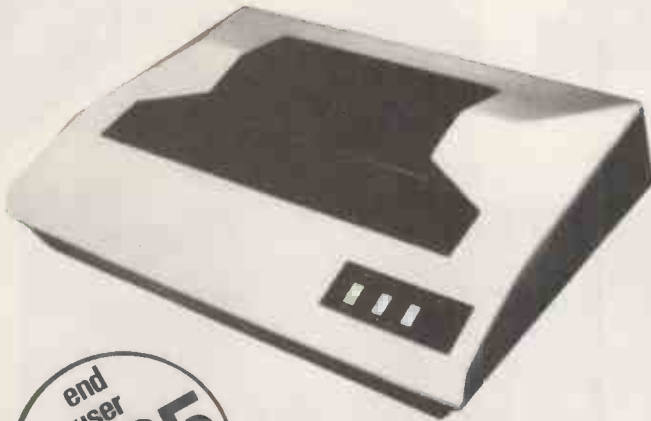

end
user
£525
+ VAT

9 × 7 dot matrix
10 Characters per inch
6 lines per inch
Full ASC II 96-Character set
750 Character buffer
Continuous duty print head
64 Graphic Characters 11 × 7 matrix
10 user Definable Characters
Double width characters
10 lines per second paper advance
Adjustable sprocket feed
Original and up to two copies
Horizontal and vertical tabs
Self test
132 characters per line optional
Quiet operation

The many advanced features are summarised in the following specification:

80 CHARACTERS PER LINE

INTERNAL 9-LINE BUFFER

COMPLES COMPLETE WITH ANY ONE OF THREE PLUG IN INTERFACES

1) RS 232C

2) IEEE for the PET

3) PARALLEL

+ 20mA CURRENT LOOP

125 CHARACTERS PER SECOND

BI-DIRECTIONAL PRINTING

NEW PRODUCTS FROM LEAR SIEGLER

ADM-3A DUMB TERMINAL GETS SMARTER!

All the features of the ADM-3A PLUS upper and lower case with line descenders, 128 ASCII character set, numeric keypad, cursor control keys and many more! **£580**

300 SERIES BALLISTIC PRINTER

Low cost 180cps microprocessor controlled printer. 15 switch selectable form lengths plus horizontal and vertical tabs. Optional 2K memory buffer.

Non-volatile forms retention, retaining form settings, even during power off. 9 × 7 dot matrix, descenders, 136 columns. **£1350**

OUR RANGE OF PERIPHERALS ALSO INCLUDES

Elibt DSI920X

Full Hazetine range

ADM-3A/L, -3A+, -31, -42

CPU Mk VI

NEC SPINWRITER

Decwriter LA-34

Decwriter LA-38

Oki Microline 80



ZILOG MCZ 1/20A

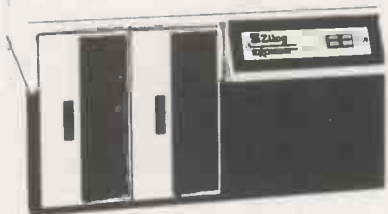

Multi-Purpose Microcomputer System * Z80 CPU * 64K bytes RAM * 9-slot chassis with power supply and fan
Expandable * Four floppy disk drives may be added * Capable of supporting four hard disks * Prewired for multi-terminal capability * Easy to use * Powerful system software * Five high-level languages: BASIC, COBOL, FORTRAN, PASCAL, PLZ * **Reliable** * Built from standard OEM boards * Efficient two board design * **Support** Nationwide field service * Factory hot lines * Training * Documentation * **Multi-Terminal Capability** * Allows up to five users * Supports Multi-Terminal COBOL

CROMEMCO SYSTEM 3



CROMEMCO SYSTEMS

*Up to seven users * Business software * Structured Basic * Fortran * Cobol * Word Processing * Assembler * CP/M compatible * Data-Base * 1 Megabyte standard * 2 Megabytes options * 11/22 MB Hard disk

We can offer a wide range of well proven software for our entire range of computers from languages through to commercial accounting systems, payroll and stock control.

We can also offer Consultancy, programming and prototype hardware design facilities. Our Consultants and programmers have many years commercial and scientific computing experience, on a wide range of computers from mainframe to micro. Contact us now with your requirements.

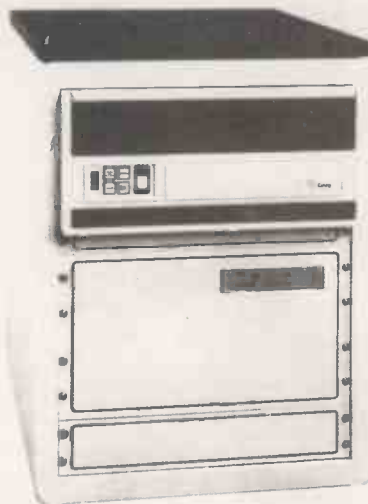

ZILOG MCZ 1/25

with up to 40 Megabytes of fixed/exchangeable disk capacity



Exidy Sorcerer

48K Machine with Z80 processor and 8K ROM BASIC. 128 Character ASCII keyboard and superb graphics. DOUBLE DRIVE configured MICROPOLIS DISK SYSTEM with MDOS or CP/M 630Kb. Professional quality monitor, various sizes up to 16".

Alternatively, now available, the new VIDEO-DISC UNIT incorporating dual disc drive and screen. Printer — optional 80 or 132 column printer. Software packages are available, including the Word Processing EPROM PAC, or can be written to your own specification. The system can be expanded to suit your own applications.



A division of
CRAYWORTH (COMPUTER SERVICES) LTD.

SHOWROOM and OFFICES

34B London Road, Blackwater,
Camberley, Surrey.

Telephone: 0276 34044. Telex 858893

open Monday-Friday 9 a.m. - 6 p.m.

Saturday 10 a.m. - 5 p.m.

by appointment only

Personal Callers Welcome.

Please phone first if you require a personal demonstration.

**** WIDELY USED IN UK AND USA ****
 **** TESTED AND PROVEN ****
 **** POWER AT YOUR FINGERTIPS ****
 **** JUST COMPARE THIS LIST ****

- ++ Robust set of programs with error traps covering Pet DOS rename malfunctions, casual user error, disk failures, Pet DOS mismanagement block allocations, disk failures, fast single key stroke entries, controlled input with visible line length, and date verifications preventing erroneous date entry.
- *** Comprehensive database management system includes
 - **** File create/delete/search
 - **** Record create/delete/search/amend/print 4 ways
 - **** Record sort by any field both alpha or numeric
 - **** Index search or general scan by any field (eg Town or Credit Limit)
 - **** Four arithmetic functions to use as calculator on last four fields
 - **** Auto check to prevent double entry with file management system dynamically allocating information for minimum disk space consumption.
- ++ Auto Invoice Numbering (with override option), plus Auto Printout integrated with address and stock files for Payment Term Discount, Agent Allocation, Price Index Retrieval and Auto Stock Update; nominal codes retrieved from address files may be optionally overridden.
- ++ Powerful alternative double entry system (general and open item) including nominal codes providing a bureaux type facility for tracking monthly trading figures and tax accruals.
- ++ Currently using 16 Sale and 66 Purchase commodity codes which are automatically written into ledgers from address files (includes override option).
- ++ Automatic triple posting of sales/purchases to invoice & general & open item ledgers with complete audit trail to include account verification on payments in/out, so that discrepancies are re-allocated to outstanding accounts, or optionally written off as discounts to the cash book. This facilitates part payments.
- ++ Final Liquidity strikes a complete audit trail balance with Creditors and Debtors O/S Amounts, Bank Balances, Stock Movements, and Remaining Stock Value to give profitability of company in both Financial and Stock Asset terms.
- ++ Powerful account tracking facilities include auto statement production for all accounts excluding Nil Balances, with date comparison age analysis to * Current * 30 Days * 60 Days * 90 Days * and appropriate messages when a date block has an inclusion.
- ++ Complete Search/Create/Amend/Delete/Sort/Facilities on any Significant Ledger Heading against either Open or General Ledger in Date/Invoice/Account/Agent/Nominal Code/Headings, for full information retrieval such as a shortlist or overdue account for a specified month, account ledger card retrieval, nominal analysis etc.
- ++ --- NO --- special printed stationery needed so 50-100 invoices cost you a fraction of a penny each, and they are formatted precisely to fit in a standard 'Ryman' window envelope for convenient posting. Tracking program enabling printing of past invoices - recall on screen. Plus monitor of specified sales - purchases of commodities by code.
- ++ Monthly quarterly tax calculations plus standard mailing ticket print facilities.
- ++ Add-on option of Auto Stock Movement Report and Update Quantity on hand plus valuation of residue as result of purchases and sales.
- ++ Add-on option of Auto Bank Update from receivables and payables against ledgers.
- ++ Stores up to 2200 addresses or up to 4000 simple ledger records on the diskette with 160K of user menu callable programs from other disk. --- ONLY ONE PROGRAM DISK --- and the hard core programs can't be busted.
- ++ Substantial user group in UK and abroad with all positive feedback implemented every 3/4 weeks and re-distributed free of charge (except cost of disk and mailing 50-70 pounds P.A.). So you become part of a commonwealth of users working with an identity of interests.
- ++ This must be surely the most comprehensive, compact, proven, and cost-effective ongoing package on the marketplace at this point in time.
- ++ Total price version 475 pounds Add-on Stock Option 100 pounds ... Add-on Bank Option ... 100 pounds ... Remaining programs 19,20,22,23 jointly 100 pounds.
- ++ Think of just keying in 100 invoices, 50 cheques? (provided you left your printer on which paper in) you could leave our programs to do all he secretarial posting automatically, after which you may set in motion the Auto Statement Run, then you can simply post out all paperwork with statements age analysed to the appropriate statement comments ...
- ++ CPM version special note *** written on the New Superbrain Processor with three higher levels of operation.
 - ***** 1 = All files are fully random access so retrieval of any record in the system takes no longer than several seconds followed immediately with the option to amend/print/delete/quit/or carry on searching through any field.
 - ***** 2 = Entire former set of Pet programs are now just one program resident in core. Once invoked from disk (under MBASIC) the user may insert two empty data disks in both drives of the system enabling a higher magnitude of disk space for more data storage. (Standard Superbrain Twin Drives can store 3000 stock items or 4500 ledger records. 800K Superbrains can store 7000 names and addresses or 9000 stock items or 12000 ledger records * all instantly retrievable) New System 33 with 2.4 Megabytes disk storage can handle 20000 names and addresses or 40000 ledger entries.
 - ***** 3 = Fully translatable program with resident vocabulary which may be translated into foreign language in a matter of hours.

SUPERBRAIN™

System Specifications

CPU: Microprocessors Twin Z80A's with 4MHz Clock Frequency. One Z80A (the host processor) performs all processor and screen related functions. The second Z80A is "down-loaded" by the host to execute disk I/O. When not processing disk data, the second Z80 may be programmed by the host for other processor related functions. Word Size 8 bits. Execution Time 1.0 microseconds register to register. Machine Instructions 158. Interrupt Mode All interrupts are vectored.

Floppy Disk: Storage Capacity 320K total bytes formatted on two Shugart double density drives. Optional external 10-300 megabyte hard disk storage is available using optional S-100 bus adaptor. Data Transfer Rate 250K bits/second. Average Access Time 250 milliseconds. 35 milliseconds track-to-track. Media 5 1/4 inch mini-disk. Disk Rotation 300 RPM.

Internal Memory: Dynamic RAM 64K bytes dynamic RAM. Static RAM 256 bytes of static RAM is provided in addition to the main processor RAM. This memory is used for program and/or data storage for the auxiliary processor. ROM Storage 1K bytes standard. Allows ROM "bootstrapping" of system at power-on. ROM storage is 2708 compatible and may be reprogrammed by the user for custom applications.

CRT: Display Size 12-inch, dynamically focused. P4 phosphor. Display Format 25 lines x 80 characters per line. Character Font 8 x 8 character matrix on a 8 x 12 character field. Line Drawing Characters Eleven special graphics symbols used for form generation. Display Presentation Light characters on a dark background. Reversible through keyboard/program selection. Bandwidth 20 MHz. Cursor Reversed image (block cursor).

Communications: Screen Data Transfer Memory-mapped at 38 kilobaud. Serial transmission of data at rates up to 9600 bps. Auxiliary Interface Universal RS-232 asynchronous. Synchronous interface optional. Parallel Interface Radio Shack TRS-80 compatible. S-100 Bus Printed circuit edge connector provided for connection of optional S-100 bus adaptor. Transparent Mode Enables display of all incoming and outgoing control codes. Parity Choice of even, odd, marking, or spacing. Transmission Mode Half or Full Duplex. One or two stop bits. Addressable Cursor Direct positioning by either discrete or absolute addressing.

System Utilities: Disk Operating System CP/M. DOS Software An 8080 disk assembler, debugger, text editor and file handling utilities.

Optional Software: FORTRAN ANSI standard. Relocatable, random and sequential disk access. COBOL ANSI standard. Relocatable, sequential, relative and indexed disk access. BASIC Sequential and random disk access. Full string manipulation, interpreter. Application Packages Extensive software development tools are available including software for the following applications: Payroll, Accounts Receivable, Accounts Payable, Inventory Control, General Ledger and Word Processing.

Keyboard: Alphanumeric Character Set Generates all 128 upper and lower case ASCII characters. Special Features N-Key Rollover, Automatic repeat (at 15 CPS), Keyboard lock/unlock. Numeric Pad 0-9, decimal point, comma, minus and four user-programmable function keys. Special Functions Keys Up to 64 user-defined two-key function sequences. Cursor Control Up, down, forward, backward, and home.

Internal Construction: Cabinetry Structural foam. Component Layout Two board modular design. All processor related functions and hardware are on a single printed circuit board. All video and power related circuits on a separate single board. These two boards are interconnected via a single 22-pin ribbon cable. Mounting CRT and two circuit boards mounted to base. CRT in a rigid steel frame. Disk Drive assembly mounted into upper cover for ease of servicing.

Environment: Weight Approximately 45 pounds. Physical Dimensions 14 3/8" (H) x 21 3/8" (D). Environment Operating: 0° to 50° C Storage: 0° to 85° C; 10 to 95% rel. humidity - non condensing. Power Requirements 115 VAC, 60 HZ, 1 AMP (optional 230VAC/50HZ model available).

*Specifications subject to change without notice.

+++++ SPECIAL INSTITUTION AND UNIVERSITY DISCOUNTS +++++
 STOCK AND COMING ROUND. (BARCLAYCARD WELCOME OTHERWISE CHEQUE WITH ORDER)
 CONTACT TONY WINTER 01-636 8210
 89 BEDFORD COURT MANSIONS,
 BEDFORD AVENUE, LONDON WC1. U.K.

NEW

Produced in U.K. and widely used in England and U.S.A.

Complete Business Package

**INCLUDES EVERYTHING FROM INVENTORY TO SALES SUMMARY
PROMPTS USER, VALIDATES EACH ENTRY, MENU DRIVEN**

BUS VER 3.00 TO VER 8.00 PET AND CP/M

APPROXIMATELY 60-100 ENTRIES/INPUTS REQUIRE 2-4 HOURS WEEKLY AND ENTIRE BUSINESS IS UNDER CONTROL

* PROGRAMS ARE INTEGRATED

- 01 = *ENTER NAMES AND ADDRESSES
- 02 = *ENTER/PRINT INVOICES
- 03 = *ENTER PURCHASES
- 04 = *ENTER A/C RECEIVABLES
- 05 = *ENTER A/C PAYABLES
- 06 = *ENTER/UPDATE INVENTORY
- 07 = *ENTER/UPDATE ORDERS
- 08 = *ENTER/UPDATE BANKS
- 09 = *EXAMINE/REPORT SALES LEDGER
- 10 = *EXAMINE/REPORT PURCHASE LEDGER
- 11 = *MONITOR INCOMPLETE RECORDS
- 12 = *EXAMINE PRODUCT SALES

SELECT FUNCTION BY NUMBERS

- 13 = *PRINT CUSTOMERS STATEMENTS
- 14 = *PRINT SUPPLIER STATEMENTS
- 15 = *PRINT AGENT STATEMENTS
- 16 = *PRINT TAX STATEMENTS
- 17 = *GENERAL HELP
- 18 = ALTER VOCABULARIES
- 19 = PRINT YEAR AUDIT
- 20 = PRINT PROFIT/LOSS A/C
- 21 = ENDMONTH MAINTENANCE
- 22 = PRINT CASHFLOW FORECAST
- 23 = ENTER PAYROLL. NO RELEASE
- 24 = EXIT SYSTEM

.....ENTER WHICH ONE?

DATABASE MANAGEMENT INCLUDES

*** FILE CREATE/DELETE/SEARCH. *** RECORD CREATE/DELETE/SEARCH/4 OPTION PRINT. *** RECORD SORT ANY FIELD ALPHA OR NUMERIC. *** INDEX SEARCH OR GENERAL. SCAN/PRINT IN ANY FIELD (EG TOWN OR NAME). *** 4 ARITHMETIC FUNCTIONS TO USE AS CALCULATOR ON LAT 4 FIELDS. *** AUTO CHECK TO PREVENT DOUBLE ENTRY TO FILE MANAGEMENT SYSTEM, DYNAMICALLY ALLOCATING INFORMATION TO MINIMISE DISK SPACE CONSUMPTION

VERY FLEXIBLE. EASY TO USE

G.W. COMPUTERS U.K. ARE THE PRODUCERS OF THIS BEAUTIFUL PACKAGE

VER 3.00 (EXC PROG 19,20,22,23) = 475.00, VERY 4.00 INCLUDES AUTO STOCK-UPDATE = 575.00, VER 5.00 INCLUDES AUTO BANK UPDATE = 675.00, VERY 6.00 IN CORE = 775.00, VER 7.00 (INC 19,20,22,23) NOT YET RELEASED = 875.00, VER 8.00 RANDOM ACCESS = 900.00, VER 9.00 TRANSLATEABLE = 975.00. ***EACH-LEVEL OVERRIDES LOWER ONE

**WE EXPORT TO ALL COUNTRIES • CALLERS ONLY BY APPOINTMENT • CONTACT TONY WINTER ON 01-636 8210
89 BEDFORD COURT MANSIONS, BEDFORD AVENUE, LONDON W.C.1.**

NOTE!!! All versions, especially 9.00 use broad financial principles and 9.00 is one 16K core program releasing both disk drives for data storage, as well as being translateable into any foreign language.

IMPORTANT!!! We also sell the hardware for the above tasks to enable the purchase from one source, and offer a general file database management system (value £100) plus 1 years software support (value £50) FREE with a total system purchase

PET 2 PET • PET • PET • PET 2 PET • PET • PET	
CBM 32K 3032	£795.00
CBM 3040 DISKS	£795.00
CBM 3022 PRINTER	£525.00
CBM CABLES FOR ABOVE PAPER AND 10 DISKS	£45.00
	£57.00
SUPERBRAIN • SUPERBRAIN • SUPERBRAIN • TWIN 280CPU TWIN D/D/DRIVE 64K RAM AND CRT	
	£1950.00
S100 BUS ADAPTER	£250.00
ADD-ON 11 MEG DISK	P.O.A.
S/BRAIN QUAD .800K	£2300.00
PRINTERS • PRINTERS • PRINTERS • PRINTERS	
PAPER TIGER 195CPS	£575.00
TELETYPE 43SR 30CPS	£875.00
DEC-LA34 TRACT 30CP	£875.00
NEC-SPINWRITER	£1650.00
QUME DAISY SPRINTS	£1950.00
TEXAS 810 150CPS	£1395.00
SPECIALS • SPECIALS • SPECIALS • SPECIALS	
IMS 48K TWIN D/D/D	£1750.00
N/STAR QUAD .7 MEG	£2150.00
INTERTUBE III TERML	£495.00
COMPUTHINK • 800K •	£795.00
CORDLESS PHONE INOUT	£195.00
TELEPHONE ANSWER	£230.00
CORDLESS PHONE IN	£80.00

SOFTWARE • SOFTWARE • SOFTWARE •	
COMMACCOUNTS	£650.00
COMPAY	£150.00
COMBIS/COMSTOCK	£150.00
WORDPRO I	£75.00
WORDPRO II	£150.00
WORDPRO III	£475.00
VER 3.00	£475.00
VER 4.00 STK/BNK	£575.00
VER 9.00R/ACCESS	£975.00
W/STAR TEXT/PROC	£250.00
WORD-MASTER TX/ED	£75.00
MBASIC 80	£150.00
COBOL 80	£320.00
PASCALZ	£150.00
FORTRAN 80	£200.00
ED/ASM S/BRAIN	FREE
PASCAL-M	£250.00
BYSTAM	£75.00
SUPERSORT	£120.00
BASIC COMPILER	£190.00
DESPOOL	£30.00
BYSTAM IMS/N-STAR	£75.00
TEXTWRITER	£75.00
POSTMASTER	£75.00
SELECTOR 3	£180.00
CBASICIMS	£75.00
CPM MACRO 80	£75.00
CPM BASCOMPILER	£190.00

**WARRANTY • WARRANTY • WARRANTY •
90 DAY FREE REPLACEMENT**

VARIOUS • VARIOUS • VARIOUS • VARIOUS •
WE SPECIALISE IN THE NEW SUPERBRAIN DOUBLE DENSITY TWIN DISK AND QUAD DENSITY 800K TWIN DISK COMPLETE MICRO-COMPUTERS WITH THE FULLEST HARDWARE AND SOFTWARE SUPPORT. ALL YOU NEED WITH THIS SUPERB SYSTEM (HOUSED IN ONE FINE MODULE) IS ANY RS232 PRINTER. IT IS POSSIBLE TO EXPAND THE STORAGE CAPACITY OF THE LARGER 800K WITH UP TO 11 MEG HARD DISK AS WELL AS LINKING 32 SUPERBRAINS TOGETHER WITH A MULTI USER BASIC THIS UNDOUBTEDLY IS ONE OF THE BEST SYSTEMS ON THE MARKET AT THIS TIME. WHY NOT CALL TONY WINTER AND ASK FOR MORE INFORMATION
NEW SYSTEM 33 Z8085 48/64K + 2.4 MEG 8" DISK LIKE SUPERBRAIN 4250.00 8" DISKS ALL IN THE CRT

**+++++ SPECIAL INSTITUTION AND UNIVERSITY DISCOUNTS +++++
STOCK AND COMING ROUND. (BARCLAYCARD WELCOME OTHERWISE CHEQUE WITH ORDER)
CONTACT TONY WINTER 01-636 8210
89 BEDFORD COURT MANSIONS,
BEDFORD AVENUE, LONDON WC1. U.K.**

NANOCOMPUTER[®]

THE COMPUTER FOR LEARNING ALL ABOUT COMPUTERS.

The microprocessor boom has left in its wake a scarcity of engineers who need to know how to realise to the full the potential of these powerful devices.

SGS-ATES, who have been producing microprocessors longer than any other European manufacturer, are now producing the NANOCOMPUTER, a professional and complete educational microcomputer system specially designed for learning all about microcomputers.

Teaching and Learning: two facets of a single problem.

All learning must be a blend of teaching reinforced with practical training.



NBZ80-S. CPU board, experiment board, keyboard, card frame/power supply, connecting wires, training books Vol. 1 and 3, Technical Manual.

The NANOCOMPUTER has been designed to be both tutor and training aid.

It is the result of SGS-ATES many years experience not just in component and systems production but also in the training of both design and production engineers at the very highest level.

The NANOCOMPUTER, based on the powerful Z80 microprocessor produced by SGS-ATES, is not just a microcomputer but rather a complete, modular educational system designed to grow with the student.

It comes complete with text books in the major European languages, technical manuals and experiment kits.

All these features make the NANO-

COMPUTER an obvious choice not only for supervised courses in schools but also for the engineer who wants to learn in a more personal way all about micro-computers.

NANO-COMPUTER:
a modular system.

The conceptual design of the NANOCOMPUTER, specially created for educational use, combines the exactness of science with the flexibility demanded by the learning process which must be at the same time both theoretical and practical.

The NANO-COMPUTER in its simplest form, NBZ80-B, allows even the new-comer to micro-processors to master programming techniques.

Further up the scale the NBZ80-S introduces him to logical circuits then takes him on to learning how to interface a microprocessor with external devices.

Each learning step taken by the stu-

dent is matched by the NANOCOMPUTER which has been designed for expansion, with a series of upgrade kits, from the simple NBZ80-B through to the NBZ80-S onto a final version with which he can learn not just about programming in the BASIC high-level language but how to use it as an integral part of a hardware system.



NBZ80-B. CPU board, keyboard, card frame/power supply, training book Vol. 1, Technical Manual.

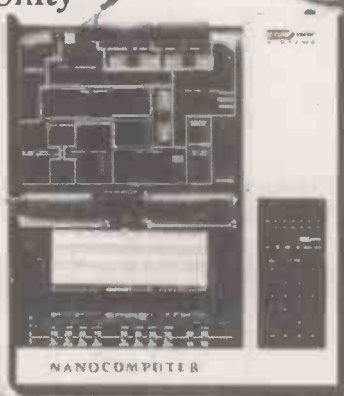
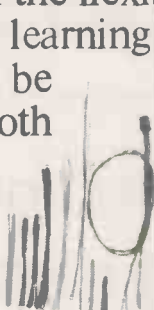

NBZ80-HL. As NBZ80-S, with 16k bytes of RAM, expansion board with 8k BASIC ROM, video interface board, alphanumeric keyboard, book "BASIC Programming Primer". (TV monitor is optional).



Please send more information about your NANOCOMPUTER® PC7

Name _____ Address _____

City _____ Country _____

Profession _____

Send to: SGS-ATES (UK) Ltd.
Planar House - Walton Street
Aylesbury - Bucks.
Tel. (0296) 5977



SGS-ATES (UK) Ltd. - Planar House - Walton Street - Aylesbury - Bucks - Tel.: (0296) 5977 - Telex 83245. • SPECIALIST MICROPROCESSOR DISTRIBUTORS: Cambridge Microcomputers Ltd. - Cambridge Science Park - Milton Road - Cambridge - Tel. (0223) 314666 • Midwich Computer Company Ltd. - 9 Churchgate Street - Old Harlow - Essex CM17 0JS - Tel. (0279) 412605 • Distronic Ltd. - 50/51, Burnt Mill - Elizabeth Way - Harlow - Essex - Tel. (0279) 32947 - Telex 81387 • Quarndon (Semiconductors) Electronics Ltd. - Slack Lane - Derby DE3 3ED - Tel. (0332) 32651 - Telex 37163.

• Circle No. 106.

ARE YOU ILL-TREATING YOUR PET?

IS YOUR PET TIRED, LISTLESS & IRRITABLE ?
THEN FEED IT MORE NOURISHING SOFTWARE
FROM THE NEW

Softcentre

RANGE

DOZENS OF EXCITING, INTERESTING & EDUCATIONAL
PROGRAMS, MOST WITH SUPERB GRAPHICS & MANY
WRITTEN BY JIM BUTTERFIELD

**GAMES = BUSINESS = EDUCATION
SCIENTIFIC & UTILITY**

SEND STAMP FOR CATALOGUE TO DISTRIBUTORS

**OPTELCO 26 ALBANY ROAD
RAYLEIGH ESSEX**

(FREE VOUCHER WORTH £2 WITH CATALOGUE)

AREA AGENCIES & OVERSEAS DISTRIBUTORS INVITED

PROGRAMMERS! HAVE YOU WRITTEN REALLY ORIGINAL PROGRAMS

OF OUTSTANDING QUALITY ? WE PAY GOOD ROYALTIES FOR THE

RIGHT MATERIAL - SEND CASSETTE FOR ASSESSMENT AND YOU

WILL RECEIVE ANY OFFER WITHIN A WEEK !

P.S. LOTS OF SOUND & PRINTER PROGRAMS IN THE RANGE

SUPPORT MEMBERS OF THE COMPUTER RETAILERS ASSOCIATION ...



THEY WILL SUPPORT YOU.

For further details on the associations aims,
membership, code of conduct etc.

Please contact: Mrs Helen Gibbons,
Owles Hall, Buntingford, Hertfordshire SG9 9PL.
Tel: Royston (0763) 71209

• Circle No. 107



CREAM MICROCOMPUTER SHOP

FOR



PET & APPLE COMPUTER SYSTEMS

IN

NORTH WEST LONDON

(Official Business Dealers and Service Agents)

- * FULL range of hardware & Peripherals
- * COMPREHENSIVE Stock of Programs for Business, education & Pleasure.
- * SPECIAL Business Programs
- * SPECIAL Business Programs undertaken by our Professional team of Programmers.

- * WIDE selection of Books, Discs, Cassettes, etc.
- * INFORMATIVE Demonstrations given.
- * AFTER SALES Service available.
- * FRIENDLY Professional Service.
- * LARGE modern shop.

**STOP PRESS ...
ITT 2020S 16K
SPECIAL PRICE
LIMITED PERIOD
£650 + VAT**

"We now stock a large
selection of Electronic
Components!"



ALL THIS & MORE

AT

380 STATION ROAD, HARROW, MIDDLESEX HA1 2DE.

3 MINS HARROW-ON-THE-HILL (MET LINE)

OPEN TUESDAY - SATURDAY 10 a.m. - 6 p.m.

Tel: 01-863 0833

ACCESS & BARCLAY CARD WELCOMED

• Circle No. 108

INNOVATIVE

TRS-80 SOFTWARE

FROM THE PROFESSIONALS

MACHINE CODE FROM A PROGRAMMER'S VIEWPOINT

- Ⓜ HOW TO M/C PROGRAM
- Ⓜ ROM CALLS LISTED
- Ⓜ RAM LEVEL 2 USAGE
- Ⓜ DISKS EXPLAINED

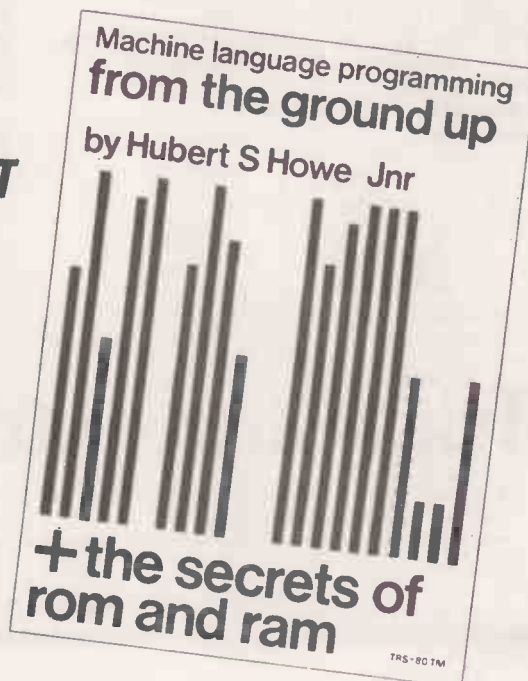

A book written by a well known programmer for people who not only want to learn machine code programming but who also want to use their knowledge in practical programming applications - from the ground up. Learning the Z-80 mnemonics, register handling and so on is important but what is essential is to be able to call the dozens of subroutines in Level 2 ROM, how to make use of the ROM user addresses in RAM and to know how the disk directories work. To learn your machine code programming from a book which does not contain this information is akin to driving a car without knowing the route you wish to take - it can be done but it is much easier knowing where you are going and how to get there !

Hubert Howe's book is written in easy to understand language and in a clear and logical manner. Two-thirds of the book is devoted to actual applications and examples. It assumes that the reader has no knowledge of the subject. If you can use Basic, you will understand this book.

£ 8.50

Plus 50p P & P.



Send large SAE (27p) for our current catalogue of TRS-80 software. Add £1.85 for a binder

A.J.HARDING (MOLIMERX)

28 COLLINGTON AVENUE, BEXHILL-ON-SEA, E. SUSSEX. TEL: (0424) 220391

TELEX 86736 SOTEX G FOR A. J. HARDING



• Circle No. 109

Software for CP/M

QUALITY PACKAGES DIRECT FROM U.S.A.

CBASIC-2	£75
Extended Disk Basic for Commercial work	
WORDSTAR	£250
Ultimate in micro Word Processing Software	
SELECTOR III - C2	£185
Best selling DBMS	
SUPERSORT I	£140
(relocatable & executable)	
SUPERSORT II	£115
(executable only)	
SUPERSORT III	£85
(as II but without Select/Exclude)	
Sort/merge and select/exclude	
WORDMASTER	£85
Superior full screen text editor	
TEX-WRITER	£50
Output formatter	
IBM-CP/M COMPATIBILITY	£110
3740 data exchange with CP/M	

CASH WITH ORDER

ADD 50p/Item P&P (Min £1) and VAT (15%)

STATE Computer and Disk size/format

Due to Dollar fluctuations, Prices subject to change without notice.

Telesystems Ltd

P.O. BOX 12, GT. MISSENDEN BUCKS HP16 9DD
02406 5314

• Circle No. 110

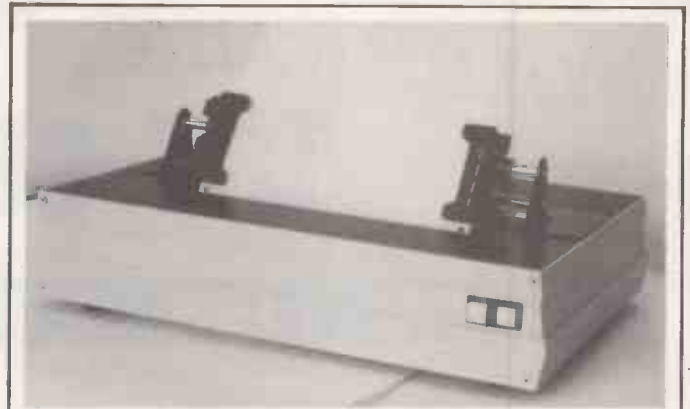

Z-800 MATRIX PRINTER

This low cost and compact printer has the following features as standard:

RS232, 20mA loop, Centronics parallel, IEEE488 I/O

72, 80, 96, 120, or 132 characters per line

User defined character set — software selectable

Tractor feed 9 1/2" wide paper. Pressure feed 8 1/2" wide paper

16 input data rates from 75 to 19200 bauds

2K terminal buffer Fast paper feed Self test switch

Price £385.00 + VAT + carriage

Send stamped addressed envelope for details of this new printer, our range of programs and programming aids to:

ZERO ONE ELECTRONICS

36 Oaklands Avenue,

Thornton Heath, Surrey

CR4 7PH

Tel: 01-689 7924

• Circle No. 111

HARD BARGAINS

A wide selection of hard disc units for S-100 Micro-Computers

Features:—

Choice of disc-controllers

Choice of operating systems

10-M Byte Winchester Drive

£3300

26-M Byte Shugart Drive

£4000

Video Tape Back Up Device

£400

Also:—

10 M Byte Winchester Drive and 64K RAM

Micro-Computer with cartridge tape drive

in a single unit

£7750

All prices exclude VAT

Clenlo Computing Systems

15 South View Court

The Woodlands

Beulah Hill

London S.E.19.

01-653 6028



• Circle No. 112

THE BYTE SHOP & COMPUTERLAND

Still the biggest 6 in the country

London

48 Tottenham Court Road
London W185 4TD
Tel. 01-636 0647

Birmingham

94-96 Hurst Street
Birmingham B5 4TD
Tel. 021-622 7149 Telex. 336186

Nottingham

92a Upper Parliament Street
Nottingham NG1 6LF
Tel. 0602 40576 Telex. 377389

Ilford

426/428 Cranbrook Road,
Gants Hill,
Ilford, Essex IG2 6HW
Tel. 01-554 2177

Manchester

11 Gateway House
Piccadilly Station Approach
Manchester
Tel. 061-236 4737 Telex. 666168

Glasgow

Magnet House
Waterloo Street
Glasgow
Tel. 041-221 7409 Telex. 779263

Your six main computer centres, stocked up with new equipment for 1980. Complete systems carefully chosen for their reliability and availability. Plus the widest range of software for business, education and industry. For expert advice on which system suits you best call into one of the Big Six.

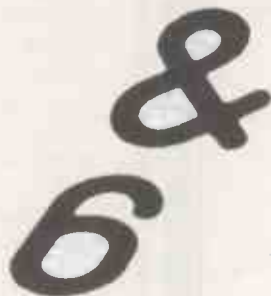

6 &

CHROMASONIC electronics

56 FORTIS GREEN ROAD MUSWELL HILL LONDON N10 3HN
TELEPHONE 01-883 3705 01-883 2289

your soundest connection in the world of components



Demonstration At Our Shop
(enter through stationers)

NOW AVAILABLE Low cost computer in kit form UK101

NO EXTRA NEEDED
SIMPLY HIT
'RETURN' AND GO

As seen in
P.E.
August to November '79

Kit price
only £199 + VAT

**UK101
CASE**
£24.50 + VAT
P&P £1.50

**NEW MONITOR
FOR UK101** £22.00 + VAT

**6502 Assembler/Editor
for UK101** £14.90 + VAT

STOP PRESS

The latest edition of our 'STOP PRESS' is now available, and contains an up-to-date price list showing all the items that we stock. Just send an S. A. E. or phone for your FREE copy.

EXTRA MEMORY
8 × 2114
only
£32.00 + VAT

INCLUDED FREE
Sample tape with extended
machine code moditor and
disassembler

Price includes RF modulator and
and supply
**ABSOLUTELY NO EXTRAS
NEEDED**

Also available ready assembled,
tested and ready to go
only £249 + VAT

Build, understand, and
program your own
computer for only a
small outlay

• Circle No. 114

MICROCOMPUTER SHOPPING MADE SIMPLE

The Slough Microshop is the Thames Valley
Specialist in microcomputer systems — for
business, professional or personal use.
Our services include:

- * TAILORMADE OR PACKAGED SOFTWARE
- * COMPLETE HARDWARE MAINTENANCE
SERVICE
- * FULL DEMONSTRATION EQUIPMENT

We are the officially approved stockist for
COMMODORE PET
EXIDY SORCERER
NORTH STAR HORIZON
APPLE II
IMS 5000/8000
EQUINOX 300

Ask for a demonstration. Phone or call into the
Slough Microshop showroom — where
microcomputer shopping is made simple.

THE SLOUGH MICROSHOP

120 High Street Slough Berkshire
Telephone: Slough 72470 or 22855

• Circle No. 115

LITTLE GENIUS

If you find self-instruction manuals difficult to
follow then meet our Little Genius.

Little Genius floppy diskettes
are the fastest, easiest way to
master your micro.

Little Genius will save you
time and effort, teaching you
to exploit all your micro's facilities.

Courses available now:

Applesoft Basic
Pet Basic
Palsoft Basic
Advanced Applesoft
Advanced Pet Basic
Advanced Palsoft
Using your Apple
Using your 2020

For further information, ask your
local dealer or contact Peter Brown
at Suite 504 Albany House, 324 Regent
Street, London, W1R 5AA.
Telephone 01-580 6361.



• Circle No. 116

PRACTICAL COMPUTING July 1980

KINGSTON

KINGSTON — KRK 1

A hardware repeat key for the PET number/cursor pad — a boon to the busy programmer and the ambitious games programme writer. Aided by the detailed instruction programme the average PET owner can upgrade his machine in a couple of minutes without fear of a fatal 'no-no'. **£17.50**

KINGSTON — KRK 2

Initially the KRK 2 was conceived as a definitive full keyboard repeat key. However, Kingston ingenuity has optimized on their patented board accessing techniques to allow two invaluable features to be added:

The first, a warm keyboard reset from otherwise fatal crashes. The second, a selectable keyboard tone which allows touch entry at otherwise impossible speeds. We can say with confidence that this unit is an absolute must for any PET user who wants to get the best from his machine. **£35.00**

KINGSTON — KC 1

A totally new concept in PET's communication with the outside world. At long last the programmer is free from the limitations of the IEEE bus. INPUT, PRINT, LOAD and SAVE to an external RS232 device are now possible without recourse to ingenious/tedious software. A comprehensive on-board firmware package allows all manner of hitherto impossible functions to be achieved including keyboard selectable configuration with full modem control. **£135.00**

KINGSTON — KC 2

Having achieved one level of impossibilities, we knew someone would need more so here it is —

Simultaneous access to two RS232 serial devices or networks with all the features of the KC 1 and more besides. With this device we give PET users serial RS232 I/O capabilities, which the owners of much more expensive machines would envy. **£150.00**

KINGSTON — KSB 1

A twenty-way RS232 multiplexing/switching box with 'mind-blowing' potential — Applications of the unit are legion and range from simple networking through multiple disc sharing to multidevice complexes based on a single processor. **£350.00**

CMC ADA 1200

A low budget IEEE 488/RS232 unidirectional interface, with a proven record of reliability (Field failure rate better than .1 percent). Since the unit is not addressable it is not recommended for use with the Commodore Disc. **£65.00**

CMC ADA 1400

An addressable IEEE 488/RS232 unidirectional interface, which is proving even more reliable than the ADA 1200 from which it was developed. While it was designed to offer only standard RS232 output it is sufficiently 'beefy' to cope with a number of less demanding current loop applications without modification. **£90.00**

CMC SADI

SADI — The microprocessor based serial and parallel interface for the Commodore PET. SADI allows you to connect your PET to parallel and serial printers, CRT's, modems, acoustic couplers, hard copy terminals and other computers. The serial and parallel ports are independent allowing the PET to communicate with both peripheral devices simultaneously or one at a time. In addition, the RS232 device can communicate with the parallel device. Special features for the PET interface include:

- Conversion to true ASCII both in and out.
- Cursor controls and function characters specially printed.
- Selectable reversal of upper and lower case.
- PET IEEE connector for daisy chaining.
- Addressable — works with other devices.

Special features for the serial interface include:

- Baud rate selectable from 75 to 192000.
- Half a full duplex.
- 32 character buffer.
- X-ON, X-OFF automatically sent.
- Selectable carriage return delay.

Special features for the parallel interface include:

- Data Strobe — either polarity.
- Device ready — either polarity.

Complete with power supply, PET IEEE cable, RS232 connector, parallel port connector and case. **£175.00**

CMC AIM 161

A low budget IEEE 488 16-channel analogue to digital converter for the competent programmer who wants to 'do his own thing'. With a 5.12 volt reference voltage the unit is normally accurate to better than .5%. **£90.00**

CMC PETSET

An AIM 161 specially configured for plug-in and switch-on use by the less technically graced user. The unit has a number of helpful extras including an input connector board allowing simple screw connection to the outside world. **£135.00**

CMC APPLESET

Similar to the PETSET, saving that the unit is configured for use with the APPLE. **£135.00**

CMC TANDYSET

Similar to the PETSET saving that the unit is configured for the TANDY TRS80. **£135.00**

CMC XPANDR 1

Analogue to digital conversion of up to 128 channels can be achieved by simply connecting as many 16-channel AIM 161 units as you need through this smart board. **£40.00**

**T
N
W**
Corporation

TNW 2000

With over 2,000 units sold, this IEEE 488/RS232 interface can truly be said to be tried and tested. Features include the conversion of both PET and true ASCII, daisy chaining and full address selection.

Standard RS232.

£135.00

Current Loop.

£150.00

TNW 3000

A bi-ported, bi-directional IEEE 488/RS232 interface offering everything the discriminating programmer could ask for. Features include independent crystal controlled Baud rate on both ports and fully implemented RS232 with extensive control line options allowing responsive throttling. **£220.00**

SSM

SSM — A10

Two powerful APPLE interface boards in one:

The first an RS232 serial with three handshaking lines (RTS, CTS and DCD), rotary switch selection of nine standard baud rates from 110 to 19200, including 134.5 for selectrics and the modes of serial communication under software control.

The second a double bi-directional parallel with four additional interrupt and handshaking lines, and interface configuration under software control. **£105.00**

NOTES

- Every Kingston product is carefully burned in and tested before dispatch.
- Kingston's guarantee, warranty and service undertakings are probably the best in the business — If you would like to see what real customer concern is all about, then send for a copy of our standard Guarantee Form!
- All prices quoted by Kingston are inclusive of packaging and shipping, but do not include V.A.T. — Please add 15% V.A.T. to any order.
- We have a number of new and exciting products 'in the pipeline' including:
 - A family of rugged, low budget EPROM programmers and duplicators.
 - A number of new cost effective printers, including daisywheels and single and double pass (better quality) matrix.
 - A low cost TRS expansion.
 - A flexible/expandable industrial control system.
 - Emergency standby power units, ranging from a .5 KVA baby to a 9.5 KVA mainline system.

If you have an interest in any of these items, give us a call. As you might expect from a company which prides itself in being different, we maintain an engineer on call eighteen hours a day, seven days a week to help you.

KINGSTON COMPUTERS LTD
Scarborough House, Scarborough Road, Bridlington. Telephone 0262 73036

• Circle No. 117





PROGRAM TAPES IN PET BASIC TO RUN ON 8K MACHINES

We've got **STAR CHESS** taped!...

Produced under licence from Videomaster Ltd., this program is an exact replica of this best selling video game. A science fiction version of Chess, pieces are armed with missiles and may fire over a range (accuracy decreases with distance). Direct hits wear down a piece's defensive shield until it is destroyed. A piece in dire trouble may warp off the board and enter hyper-space, to reappear at a random time and place later in the game. Programmed with sound, Star Chess is available on cassette for 8K + machines ... £12.99

and an **ADVENTURE** on a disc.

Adventure

Our own version of this classic computer moderated fantasy adventure game in which you explore an underground dungeon populated by snakes, trolls and menacing little goblins which constantly bar your way. As you explore, you give the computer commands such as - get gold, open lock, drop bottle, kill goblin etc. - and tell it which way you will proceed. The computer responds with your revised situation and awaits your further instructions. Available on disc only for Compu-think disc drive with 16K or 32K machines £19.95

All games use full Graphic Display

M.A.G. Program Tapes for Microcomputers

TORPEDO RUN

Manoeuvre your fighter down the trench avoiding attacks from Triad ships until the opportunity arises to release your Photon Torpedo and destroy the Death Star £7.99

YAM

A classic dice game in two versions: *Yam 1* for up to 6 players and *Yam 4*, a more skilful version, for up to 4 players £5.99

OVERLOAD

A strategic game of reactions and chain reactions in which players build up nuclear piles. *Programmed with sound.* £7.99

FINAL FRONTIER

This *Star Trek* game combines features of the other *Star Trek* games. Explore the galaxy to exterminate Klingon Warships using your ship's computer £7.99

Games Workshop

1 DALLING RD, HAMMERSMITH, LONDON W6

Tel: 01 741 3445 Ravenscourt Park tube

Open: Mondays-Fridays, 10.30-6.00, Saturdays, 10.00-5.30

MAIL ORDER - Please make cheques payable to 'Games Workshop'. UK orders sent post free. Overseas please include 25p per tape (surface) or 50p per tape (air). FURTHER DETAILS - Send a stamped, addressed envelope for our catalogue sheet.

TRADE ENQUIRIES WELCOME

WHEN ORDERING PLEASE SPECIFY OLD OR NEW ROMs

Superboard II

8k MICROSOFT BASIC 4k RAM
- comes ready built (no hidden kit repair charges)
fully expandable to 32k dual floppy
system with printer.

Standard Superboard 50Hz £159.95 + VAT
610 Expansion Board 8k RAM ONLY £159.95 + VAT

IP CD3P Minifloppy Disc, Cased, PSU, 2 copies DOS ONLY £275 + VAT

4k RAM ONLY £24 + VAT
Plastic Case, Beige ONLY £26 + VAT

Challenger IP-Metal Cased, Superboard, PSU modulator ONLY £219 + VAT



NEW BUILT
48 X 32 VIDEO
VERSION
£199 + VAT

50Hz version
- NO FLICKER

NOW ON SHOW
IN THE
SCIENCE MUSEUM

Super Print 800



Probably the most highly featured printer for the lowest cost!

80 COLUMN HIGH PERFORMANCE IMPACT PRINTER
The ideal companion for PET, APPLE, TSR80, Exidy, Superboard, CompuKit, Ohio Challengers and most micro's

Rugged metal enclosure makes it ideal for home computing, small business systems, data logging etc.

- *RS-232, 20mA, IEEE 488 and Centronics I/O
- *16 Baud Rates to 19.200
- *60 Lines per minute - Bidirectional
- *5 print densities 72,80,96,120 or 132 Chr/Line
- *Self Test Switch *2k Buffer
- *Tractor and Fast Paper Feed/Graphics

Model 800 MST ONLY £399 + VAT

Low price PETS
- large keyboard
16k - £549 + VAT
32k - £649 + VAT



SOFTY

INTELLIGENT EPROM PROGRAMMER

Connects directly to TV. Develop, Copy, Burn, Verify 2708, 2716 and with modification 2516.

ONLY £120 + VAT Built & Tested
£100+VAT Kit. £20+VAT Built Power Supply

NOW ON SHOW
IN THE
SCIENCE MUSEUM

VIDEO GENIE based on TRS80



Utilises Z80, 12k level II Basic, 16k RAM, Integral Cassette Deck, UHF O/P, all TRS80 features ONLY £369 + VAT

ZT DRIVING COMPUTER



NEW

*MPG Instant *MPG Average *Gals. used since fillup *Miles to empty *Elapsed time *Time to empty ONLY £77.50 + VAT

!!!! SPECIAL SCOOP !!!!

Verbatim Discs in fives
5 1/4" - £1.85 (each) + VAT
8" - £2.20 (each) + VAT

STRINGY FLOPPY



NEW

Combines economy of cassette with speed & reliability of disc. (TRS80 exp.int.not req.) ONLY £189 + VAT (inc. 20 wafers (Tapes))

Mighty Micro

In association with Watford Electronics

BUY IN CONFIDENCE - In the event that we are unable to deliver your goods within 7 days, we do not bank your remittance until such time we have the goods to despatch. If on receipt of your order, the goods do not meet with your satisfaction, return within 7 days for full refund. All goods covered by manufacturers guarantee.

Please add VAT at 15%. Carriage extra, will advise at time of order. Official orders welcome. Product details on request. Trade and export enquiries welcome.
33 CARDIFF ROAD, WATFORD, HERTS. Telephone: (0923) 38923
PO Box 17, 61 NEW MARKET SQ, BASINGSTOKE, HANTS. (0256) 56417
Mail Order and Enquiries to Basingstoke



• Circle No. 118

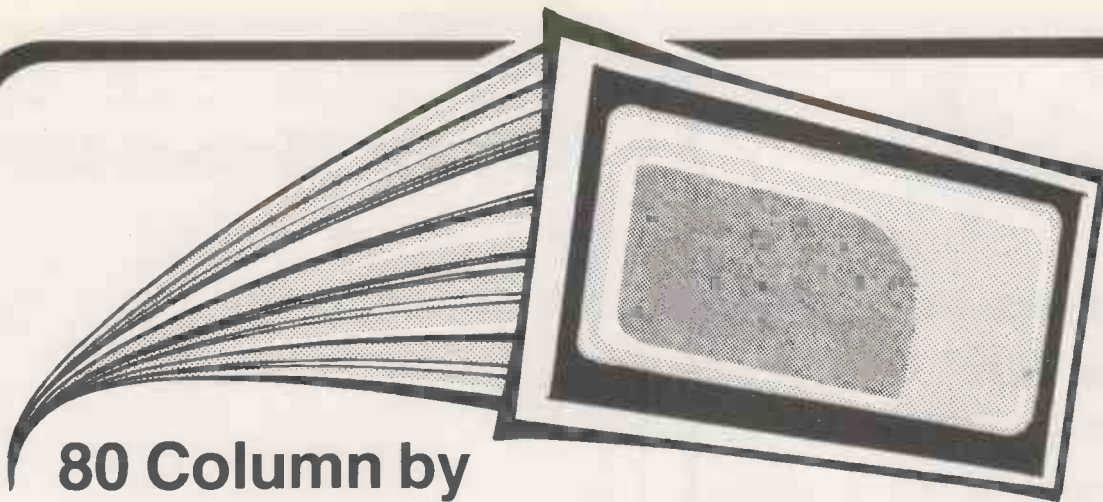

80 Column by 24 Line Plug-in Compatible Board for the Apple II Computer

SPECIFICATIONS

- * 80 Columns X 24 lines.
- * Upper and lower case data entry using the Apple II keyboard.
- * Includes 128 upper and lower case 5X8 dot matrix ASCII character set and inverse alpha characters.
- * Characters can be user definable.
- * Includes VBC video balance circuit which allows the user to display 80 columns on an inexpensive 8 MHZ CRT monitor.
- * Shift lock feature.
- * Works with Apple Pascal and Apple Basic.

- * Incorporates Pascal and Basic control characters.
- * All monitor-type escapes are valid.
- * Follows protocols of Pascal and Basic operating systems.
- * Compatible with All Apple II peripherals.
- * Effective baud rate greater than 10,000 fast scrolling and clearing.
- * Synchronous operation with Apple II.
- * Can be used with Apple II communication interface board to act as self contained terminal for time-sharing or other applications.

Video Board

Nett	Vat	Total
275.00	41.25	316.25

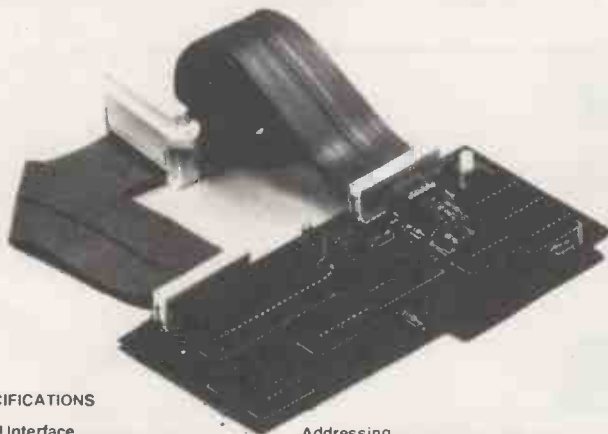

SPECIFICATIONS

Serial Interface

- * One RC-232 interface with EIA receivers and drivers
- * Available handshaking lines --Request--To--Send (RTS), Clear--To--Send (CTS), Data--Carrier--Detect (DCD)
- * Rotary switch selectable baud rates--110, 134.5, 300, 600, 1200, 2400, 4800 (9600 and 19200 baud available under software control for printers)
- * External clock input for up to 500K baud
- Software controlled modes:
 - 7 or 8 data bits
 - Even or odd parity
 - 1 or 2 stop bits
 - 1, --16, --24 baud rate divisor
 - Master reset
 - RTS mode control
- * Double buffered send and receive registers
- * Supports full duplex operation

Parallel Interface

- * Two bi-directional 8-bit ports
- * Four additional interrupt and handshaking lines
- * Interface configuration and data direction controlled by software

Firmware

- * 256 bytes of on-board PROM

Addressing

- * 6 memory mapped registers

Cable Assemblies

- * Serial interface-- 6 inch ribbon cable with DB-25 socket
- * Parallel interface-- 18 inch ribbon cable with uncommitted end

PC Board

- * High grade FR-4 blue epoxy.
- * Double sided solder mask with silk screened parts legend and gold-plated edge connector contacts.
- * Dimensions-- 2.7" x 6.3" (excluding edge connector contacts).

Miscellaneous

- * PROMs and data buffer power-down when not addressed
- * Sockets provided for all ICs

A.I.O.

Nett	Vat	Total
105.00	15.75	120.75

AIO™ Serial & Parallel Apple Interface

TWO BOARDS IN ONE

The AIO Apple Interface allows maximum flexibility for interfacing your Apple II with peripherals such as printers, plotters, terminals, modems and other computers. The AIO can communicate with both serial and parallel devices. It can even interface with both at the same time. And you won't need to write any software to operate the AIO. It comes complete with the necessary software and on-board firmware to handle serial and parallel communications.

APPLE III

Interested?? Please ring 051-933 5511!!

Please ring Paul Fullwood or Carl Phillips for other interfacing requirements.

Stack Computer Services Ltd
290-298 Derby Road, Bootle,
Liverpool L20 8LN.
051-933 5511.



**COMPUTER
SERVICES
LIMITED**

• Circle No. 119



Micro-Computer Centre for the MIDLANDS

Nascom and Commodore Specialists

A full range of micro computers and peripherals are available, whether buying or browsing we can give helpful and friendly advice.

Commodore Business Systems are suitable for the professional office, the small business or the sole trader. We will be pleased to give advice and a demonstration.

Nascom 2 systems can be fully built and tested to order. We are sole distributors for the Micro Type case for Nascom 1 and 2, also stockists of the William Stuart colour graphics and full range of 'add-ons'.



Business & Leisure Micro Computers

16 The Square, Kenilworth, Warwickshire CV8 1EB.
Tel: (0926) 512127

• Circle No. 120

Happy Memories

4116	200ns	£4.50	4116	150ns	£5.50
2114	200ns	£4.75	2114	450ns	£4.25
2708	450ns	£4.95	2716	5 volt	£16.95
21L02	450ns	85p	21L02	250ns	£1.25

VERBATIM mini discs soft sectored —
with FREE library case £19.95 per ten

SALE

We're moving shortly to new premises and don't want to carry much.

Bargains from Sat. 26th April

All prices include VAT.

30p postage on orders below £10.

Access & Barclaycard.

All orders to:

Dept. PC

**19 Bevois Valley Road,
Southampton,
Hants. SO2 0JP
Tel: (0703) 39267**

• Circle No. 121

Buying the right apple software to do the job, at the right price, can be a job in itself!

But it doesn't have to be.

Micro Management now have available a comprehensive range of quality software for business and commercial applications. Each package is user-tested before being released, and when released, carries our own guarantee. Software of such a high standard at a realistic price is hard to find, so end your search by asking for Micro Management software.

Micro Management software is available from your nearest dealer, or direct from us. We also offer a tailor-made service to suit your company's individual requirements.



MICRO MANAGEMENT

13-15 Connaught Avenue, Frinton-on-Sea, Essex. Tel: Frinton 4592
Bringing the benefits of computer technology to the smaller business

SALES LEDGER

The Micro Management sales ledger offers the following facilities and benefits:

- True aged debt analysis
- Fast name search
- Six management reports
- Three automatic overdue letters
- Up to 1,000 accounts and 2,500 transactions per month
- Combines with our invoicing and mailing list
- Validation and audit trail
- Simple disk-changing routine
- Comprehensive error routines
- Multi-option statements and day books
- Initial supply of printed statements
- Only £145 incl. p & p (ex VAT)

• Circle No. 122

'TUSCAN' FROM TRANSAM

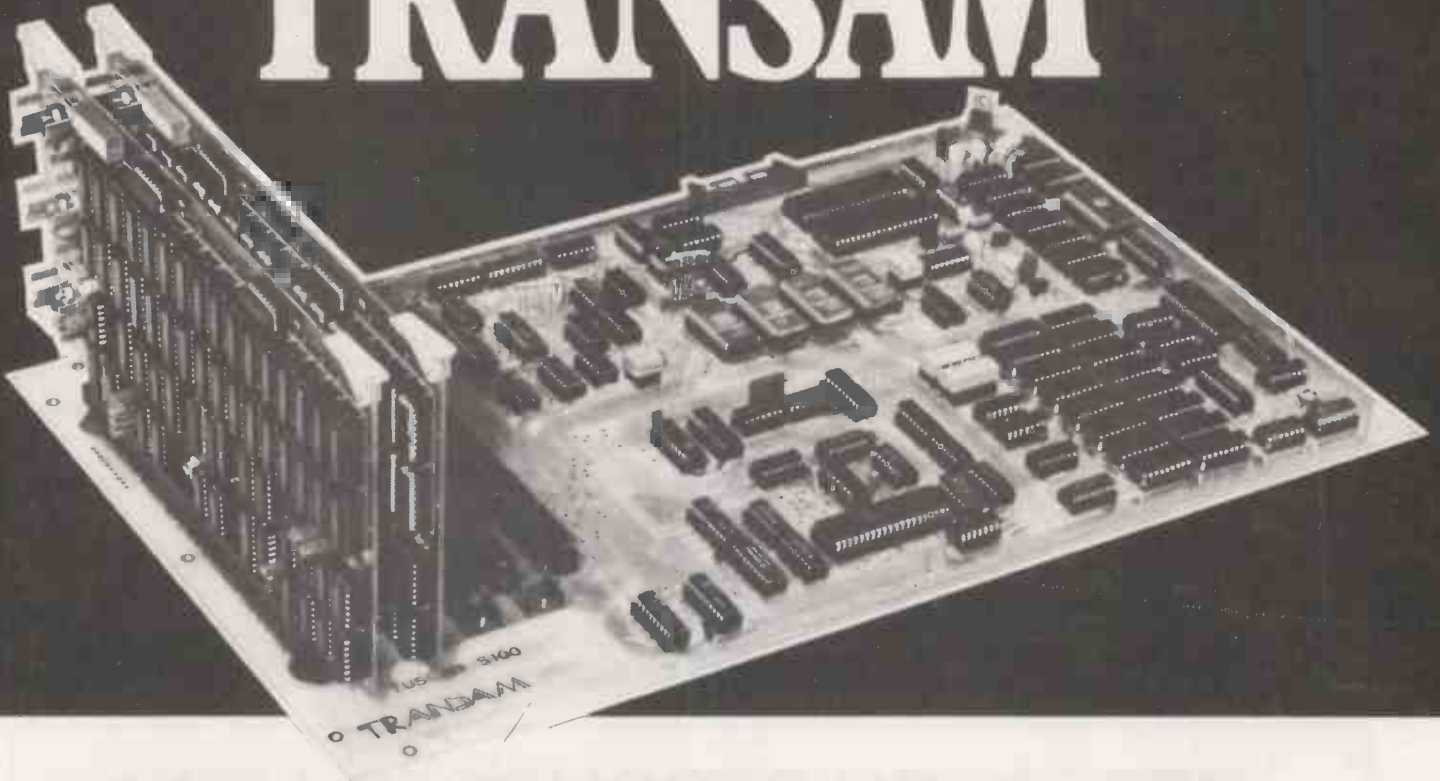

Take a step up to your next Computer!

THE CONCEPT

How many ways are there to build an S100 system? Not many, and all expensive. TUSCAN changes all that.

Five S100 boards on one single board — just for starters. Plus five extra slots for future expansion.

What a combination! Z80 and S100 with the TRANSAM total package of system and applications software.

How do we do it? Our prices start at £195 and you can build up in easy stages to a fully CP/M compatible disc based system. Something to think about!

THE HARDWARE

The first Z80 single board computer with integral S100 expansion. British designed to the new IEEE (8 BIT) S100 specification, the TUSCAN offers total system flexibility. A flexibility available now.

The board holds the equivalent of a Z80 cpu card, 8k ram, 8k rom video and I/O cards with 5 spare S100 expansion slots and offers a price/performance ratio which is hard to beat.

Just compare our price with a commercial S100 ten slot motherboard with this specification.

THE SOFTWARE

TUSCAN offers the user the choice of system monitor, editor, resident 8k basic, resident Pascal compiler or full CP/M disk operating system. All options are upwards

compatible and fully supported with applications software. Both 5¼" and 8" drives are supported in double density.

THE PACKAGE

TUSCAN is available in kit form or assembled. With several hardware and software options to suit your requirements and budget. Attractive desk top case also available holds 2 x 5¼" Drives.

TRANSAM

NOBODY DOES IT BETTER!

Send to Transam Components Ltd., 12 Chapel Street, London NW1

I am interested in the TUSCAN Z80 based single board computer with S100 expansion and enclose a S.A.E. for further details.

Name _____

Address _____

Telephone _____



centralex

CENTRALEX-LONDON LTD
8-12 Lee High Rd, London SE13
Tel: 01-318 4213/4/5/6/7
9.30 am - 5 pm Mon to Fri -
Evenings and weekends by
appointment

A comprehensive range of Microcomputers Equipment, Peripherals, Software and Services for those who value Professional Standards, Guidance and Continuing Support for Hardware and Software.

APPLE
TEXAS
MICROPOLIS
DIABLO
MICROLINE

PET
OHIO SCIENTIFIC
CENTRONICS
QUME
HITACHI

ITT 2020
CROMEMCO
ANADEX
DEC
LEXICON

EXIDY
MICROSTAR
INTEGRAL
DATA GENERAL
ETC. ETC.

HORIZON
SHUGART
TELETYPE
EPSON

INFORMEX-80 Printer

£ 399+VAT



ALSO Training, Consultancy, Systems Design,
Programming and Software

Special offer - for a limited period

For PET, APPLE, EXIDY, TRS80, ETC
A high quality, high speed printer
(125 cps) Upper and lower case letters
plus graphics as standard
Interface and cable for TRS80, PET,
APPLE or RS 232 £69 + VAT
Tractor feed option only £39

PAYROLL - INVOICING - STOCK CONTROL -
SALES/PURCHASE LEDGER - VAT - MEDICAL
RECORDS - EDUCATIONAL & ENGINEERING
PROGRAMMES - HOTEL RESERVATION - ESTATE
AGENTS - BUILDING MAINTENANCE - COBOL -
FORTRAN - ETC.

Maintenance Contracts including stand-by equipment during repair
periods - Free Delivery Nationwide - Terms arranged - Credit Cards and
official orders accepted.



• Circle No. 124

RESEARCH RESOURCES LTD.

Microcomputers for Education, Science and Technology

MULTI-USER 128K GIMIX 6809 COMPUTER

- Robust, reliable S50 Mainframe, 16/8-bit processor.
- INTEGRAL Twin mini-floppy disk drives - 340K.
- Fast 2MHz RAM Boards, switch selectable.
- Wide range of software - fully compatible with SWTP/FLEX.
- PASCAL, Scientific BASIC Interpreter/Compiler, 4 user BASIC, Editor, Assembler, Debug, Text processor etc.
- Exclusive to RRL - LAB-BASIC, SAM (Statistical Analysis for Microcomputers), A to D, D to A converters.
- SPECIAL terms for SWTP users wishing to upgrade to GIMIX.

●● RRL Specialises in designing microcomputing systems for educational and scientific use. We will supply the complete system - processor, VDU, printer, special interfaces, software etc - to solve your problem.

●● For further information please contact our offices and showrooms at:
RESEARCH RESOURCES LTD, 40 Stonehills, Welwyn Garden City, Herts AL86PD. Tel. (07073) 26633



SOFTWARE and HARDWARE for EXPERIMENTS and CONTROL

Big disk drives are expensive? RRL has developed a software package (POLYFLEX) which enables numerous linked micro-processors to TIMESHARE a 16 or 2.5 Megabyte disk system. Another RRL exclusive (LAB-BASIC) enables each user to run control programs; all software is available on both 6800 and 6809 systems.

• Circle No. 125



TERODEC

IS READY WITH SYSTEMS

INTERTEC SUPERBRAIN

More than an intelligent terminal the SuperBrain user gets exceptional computing power at low price.

- 32Kbytes of RAM (expandable to 64K).
- Dual double density mini floppies (320Kbytes).
- Dual 4MHz Z-80 CPU's.
- 80 x 25 High quality 12" display.
- Full ASCII keyboard.
- CP/M operating system.
- Dual synchronous/asynchronous RS232C ports.
- Interfaces to most printers.
- Wide range of standard software (FORTRAN, BASIC, CBASIC-2, COBOL, PASCAL, Sales Ledger, Bought Ledger, Nominal Ledger, Stock Control, IBM 3780/2780/3270 Emulation and more).
- Attractive integral desk top design.

SuperBrain with 64K

£1950.00



DELTA DPS 64/1

Professional computing system with all the features necessary for the business or scientific user.

- 64Kbytes of 4MHz RAM, operating without wait states.
- Dual double density single sided 8" drives (1 Mbyte).
- Disc storage expandable to four 8" double sided double density drives (4 Mbytes), fixed and cartridge drives.
- CP/M1.4 standard (CP/M2.0 option).
- Expandable to multi-user (CP/M2.0 with MPM).
- RAM expandable to 512KBytes multiuser.
- Large range of standard Compilers, Interpreters, Assemblers and Applications Packages available.
- TV1912 80 x 24 VDU as standard.
- Interfaces to most VDUs and printers.

£3099.00

DPS 64/2 the same spec as DPS 64/1 with 2 Mbytes of disk storage (2 double sided double density drives)

£3404.00

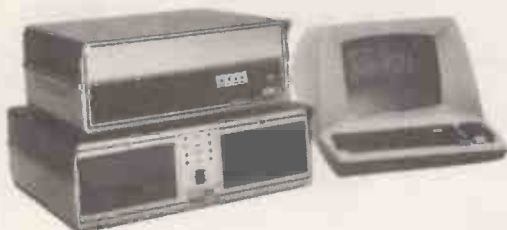

TERODEC TMZ-80 Range

Microcomputers with unrivalled flexibility to solve your business computing problems.

- Choice of operating systems — CP/M1.4 or CP/M2.0.
- Interfaces to most VDU's, line, dotmatrix, daisywheel printers and modems.
- 64Kbytes of RAM as standard (512Kbytes multiuser).
- Single or multiprocessing.
- 1-4Mbytes floppy disk storage.
- Fixed or cartridge disks.
- 4MHz Z-80 CPU.
- Comprehensive range of compilers interpreters assemblers and applications packages.
- Attractively styled workstation.

TMZ-80-1 1Mbyte 64K with VDU CP/M1.4 and workstation	£3995.00
TMZ-80-2 2Mbyte 64K with VDU CP/M1.4 and workstation	£4295.00
TMZ-80-2 4Mbyte 64K with VDU CP/M1.4 and workstation	£5595.00



TERODEC are the sole U.K. distributor for DELTA PRODUCTS and CENTRAL DATA CORPORATION.

OEM AND Dealer Enquiries Invited

TERODEC (MICROSYSTEMS) LTD
17 The Gallop, Yateley,
Camberley, Surrey.
Tel: (0252) 874790
(0344) 51160

All information is correct at the time of going to press. Prices exclude VAT and unless stated delivery.

24 TUNE DOOR CHIMES

DOOR TUNES £17.13 + VAT

Waddington's Videomaster announce a doorbell that doesn't go Brrringgg, Ding-Dong or Bzzzzz. Instead it plays 24 different classical and popular tunes. It will play the tune you select for your mood, the season or the visitor you are expecting to call. Door tunes is not only great fun and a wonderful ice breaker, but is also very functionally and beautifully designed to enhance your home. There is something for Christmas, something for your comical visitors or your relations from the states, and even something for the Queen. Door tunes is easy to install and has separate controls for volume, tone and tempo.



T.V. GAMES

PROGRAMMABLE £29.50 + VAT. COLOUR CARTRIDGE T.V. GAME.

The TV game can be compared to an audio cassette deck and is programmed to play a multitude of different games in COLOUR, using various plug-in cartridges. At long last a TV game is available which will keep pace with improving technology by allowing you to extend your library of games with the purchase of additional cartridges as new games are developed. Each cartridge contains up to ten different action games and the first cartridge containing ten sports games is included free with the console. Other cartridges are currently available to enable you to play such games as Grand Prix Motor Racing, Super Wipeout and Stunt Rider. Further cartridges are to be released later this year, including Tank Battle, Hunt the Sub and Target. The console comes complete with two removable joystick player controls to enable you to move in all four directions (up/down/right/left) and built into these joystick controls are ball serve and target fire buttons. Other features include several difficulty option switches, automatic on screen digital scoring and colour coding on scores and balls. Lifelike sounds are transmitted through the TV's speaker, simulating the actual game being played. Manufactured by Waddington's Videomaster and guaranteed for one year.



EXTRA CARTRIDGES:

ROAD RACE - £8.87 + VAT.

Grand Prix motor racing with gear changes, crash noises

SUPER WIPEOUT - £8.17 + VAT.

10 different games of blasting obstacles off the screen.

STUNT RIDER - £12.16 + VAT.

Motorcycle speed trials, jumping obstacles, leaping various rows of up to 24 buses etc.

NON PROGRAMMABLE TV GAMES

6 Game - COLOURSCORE II - £13.50 + VAT.

10 Game COLOUR SPORTSWORLD £22.50 + VAT.

CHESS COMPUTERS

STAR CHESS - £95.85 + VAT

PLAY CHESS AGAINST YOUR PARTNER.

Using your own TV to display the board and pieces. Star Chess is a new absorbing game for two players, which will interest and excite all ages. The unit plugs into the aerial socket of your TV set and displays the board and pieces in full colour for black and white on your TV screen. Based on the moves of chess. It adds even more excitement and interest to the game. For those who have never played, Star Chess is a novel introduction to the classic game of chess. For the experienced chess player, there are whole new dimensions of unpredictability and chance added to the strategy of the game. Not only can pieces be taken in conventional chess type moves, but each piece can also exchange rocket fire with its opponents. The unit comes complete with a free 18V mains adaptor, full instructions and twelve months guarantee.



CHESS CHALLENGER £85.65 + VAT

PLAY CHESS AGAINST THE COMPUTER.

The stylish, compact, portable console can be set to play at seven different levels of ability from beginner to expert including "Mate in two" and "Chess by mail". The computer will only make responses which obey international chess rules. Castling, on passant, and promoting a pawn are all included as part of the computer's programme. It is possible to enter any given problem from magazines or newspapers or alternatively establish your own board position and watch the computer react. The positions of all pieces can be verified by using the computer memory recall button.



ELECTRONIC CHESS BOARD TUTOR £17.17 inc. VAT.

A special bulk purchase of these amazing chess teaching machines enables us to offer them at only £19.75 less than half recommended retail price. The electronic chess tutor is a simple battery operated machine that can actually teach anyone to play chess and improve their game right up to championship level. This machine is not only for total beginners but also for established players wanting to play better chess. Unit contains the electronic chessboard with 32 chess pieces, a 64 page explanatory booklet and a set of 32 progressive programme cards including 6 beginners cards, 16 check mate positions, 9 miniature games, 5 openings, 3 end games, 28 chess problems and 2 master games.

Price includes unit with wood grained housing, and Staunton design chess pieces. Computer plays black or white and against itself and comes complete with a mains adaptor and 12 months guarantee.

OTHER CHESS COMPUTERS IN OUR RANGE INCLUDE:

CHESS CHAMPION - 6 LEVELS £47.39 + VAT

CHESS CHALLENGER - 10 LEVELS - £138.70 + VAT.

BORIS - MULTI-LEVEL TALKING DISPLAY £163.64 + VAT.

DRAUGHTS COMPUTERS

CHECKER CHALLENGER 2 LEVELS £43.00 + VAT. 4 LEVELS £78.00 + VAT.

The draughts computer enables you to sharpen your skills, improve your game, and play whenever you want. The computer incorporates a sophisticated, reliable, decision-making microprocessor as its brain. Its high level of thinking ability enables it to respond with its best counter moves like a skilled human opponent. You can select offence or defence and change playing difficulty levels at any time. Positions can be verified by computer memory recall. Machine does not permit illegal moves and can solve set problems. Computer comes complete with instructions, mains adaptor and twelve months guarantee.

PLAY DRAUGHTS/CHECKERS AGAINST THE COMPUTER

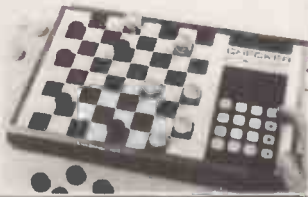

FOR FREE BROCHURES - SEND S.A.E

For FREE illustrated brochures and reviews on TV and chess games please send a stamped addressed envelope, and state which particular games you require information on.

Callers welcome at our shop in Welwyn - demonstrations daily - open from 9am 5.30pm Mon Sat 10am 1pm Wed.

To order by telephone please quote your name, address and Access/Barclaycard number.

Postage and Packing FREE

AJD DIRECT SUPPLIES LIMITED, Dept. P.C.7 102 Bellegrave Road,
Welwyn Kent DA16 3DD. Tel: 01-303 9145 (Day) 01-850 8652 (Evenings)

• Circle No. 127

DUE TO EXPANSION WE ARE PLEASED TO ANNOUNCE THE OPENING OF OUR NEW COMPUTER SHOP IN EDGWARE.

CALL IN AND SEE THESE SYSTEMS:

Word processing. Stock control/invoicing. Incomplete records. Purchase accounting. Information retrieval. Payroll. Games. Programming tutorials and many others. If you don't see what you want we will probably be able to get it for you.

We specialise in this system.

PET prices start from £495.00



We also stock the Qume Sprint 5 daisy wheel printer for the best quality word processing. Also call us for the latest second hand equipment supplies.

Open Mon-Sat. 9-5.30 at:

Stop Press. Orders now being taken for new 80 column screen PET £895 + VAT. Estimated delivery August/September.



DAVINCI COMPUTER SHOP
65 High Street, Edgware.

Tel: 952 0526



• Circle No. 128

SPECIAL LOW PRICE OFFERS

MEDIA 5 LTD.

COMPUTER TABLE (as illustrated). Fine quality teak effect on black metal frame. Height 24 1/2", Length 24", Width 18". £69.00 + £3 Carr. As above, but with casters £6.50. extra.



CALCULATORS



TR81MR DESK TOP CALCULATOR (as illustrated) 7" x 5 1/2" x 1 1/2" approx. 8 digit green display, %, / and - / +. Mains or battery operated. £15.95 + £1 p.&p.

TR121 (as illustrated) 12 digit LCD model.

4 basic, floating or set decimal point, % key and full memory. 7 1/2" x 5" x 1 1/2" approx. £24.95 + £1 p.&p.
Mains adaptor for above £4.95.



COMPUTER COVERS sewn in high quality black vinyl.
Pet Computer £8.95. Computhink) Postage 50p for 1
Disk Unit £3.15. Microprinter M879) £ 75p 3 or 4
£6.60. Pet Printer £4.25.) Packing 5 + f.o.c.
Pet Floppy Disc Unit £4.25.)

DISKETTE STORAGE SYSTEM

P.V.C. Diskette Storage Sleeve - holds two 5 1/2" diskettes and index cards. Pack of 10 plus 5 document sleeves (A4 size) £5.95. + 30p p.&p. A4 size Ring Binder for storage of above £1.50 + 30p p.&p.

All prices include V. A. T. Allow 21 days for delivery.

Orders with cheque, credit-card number, or cash to: -

MEDIA 5 Ltd., Watson Mill Lane, Sowerby Bridge, West Yorks. HX6 3BW. Tel: Halifax (0422) 33580.

TRADE ENQUIRIES WELCOME

• Circle No. 129

VECTOR GRAPHIC COMPLETE SYSTEMS



Micro-computers for research, laboratory work, word processing, business systems, Schools, Colleges, Universities and Industry. At Almarc, when you buy Vector Graphic Micro-computers, you get Almarc's experience of over 200 systems installed throughout the U.K. and their back-up of full service facilities carried out by experienced staff. Plus an ever growing list of compatible software including: Pascal, Fortran, Cobol, APL, Algol, C Basic Compiler, etc.

Vector MZ Spec

- ★ 56K Bank Selectable Ram.
- ★ 3 Serial Ports, 2 Parallel Ports.
- ★ Twin Disc Drives, 630K Capacity.
- ★ 280 CPU, with Fast 4MHZ Clock.
- ★ Prom Programmer (2708).
- ★ Interrupt Handling on I/O Board.
- ★ 18 slot Motherboard.

Vector System B

- ★ Vector Mindless Terminal.
 - ★ Flashwriter II Video Board (24 x 80).
 - ★ MDOS + CP/M2 Operating System.
- Plus Microsoft Version, 5 basic options.
Plus many S100 Bus add-ons, such as Extra Memory, A/D-D/A Boards, High Resolution Graphic, etc.

We will be pleased to demonstrate any of the Vector Graphic Systems, please contact:

ALMARC
DATA SYSTEMS LTD

906 Woodborough Road, Nottingham. Telephone: (0602) 625035

Specialists in Vector Graphic Equipment

SEE US AT THE
ONLINE MICRO SHOW,
WEMBLEY.
JULY 22nd to 24th
STAND NO.
23

TAILOR-MADE SOFTWARE*

DESIGNERS AID prints a plan, four elevations and a full costing of furniture and fittings in a specified room. The user positions articles, which can be called from a catalogue of 200 on the disc or described by the user.

NAME

POSITION

COMPANY

ADDRESS

PHONE NO.

Engineering Graphic Applications Ltd.,
27 Palace Street, London S.W.1. PC1

TIME-COSTS-INVOICING package comprises four programs which can be used separately or co-ordinated to provide for entry, sorting and editing of up to 1000 sets of records of jobs, employees or clients names and addresses. All this can be brought together to keep records of and print up to 200 invoices.

Full hardware/software packages for the above programs can be supplied.

Specimen printouts and further details are available on request.

For a free on-site demonstration, complete the attached coupon and return to us,

ENGINEERING GRAPHIC APPLICATIONS LTD.,
at: - 27 Palace Street, London S.W.1.

*...on floppy disc written in Applesoft for Apple II

• Circle No. 131

V. & T. ELECTRONICS NASCOMS NEWEST LONDON DISTRIBUTOR

NASCOM II: USES Z80A CPU SWITCHABLE 2/4 MHZ, INCLUDES 8K MICROSOFT BASIC 2K MONITOR (NAS-SYS), 1K VDU RAM, 1K WORKSPACE RAM, ULTRA RELIABLE LICON KEYBOARD, Z80A PIO GIVING 16 PROGRAMMABLE 10 LINES, KANSAS CITY CASSETTE INTERFACE SWITCHABLE 300/1200 BAUD, BASIC COMMANDS INCLUDE: NEW:LIST:CONT: CLEAR:MONITOR:RUN:NULL:SCREEN: LINES:WIDTH:DEF:DOKE:IF: THEN:FOR:DIM:END:ON:GOTO:LET:NEXT:GOSUB:RETURN:OUT:POKE:REM:STOP:WAIT:SET:RESET:PRINT:DATA:INPUT:READ:RESTORE:CLS: = : - : + : * : / : ABS:ATN:LOG:SIN:PEEK:INP:INT:SGN:TAN:SPC:POS:RND:USR: COS:SQRT: TAB:EXP:FRE:POINT:ASC:CHR:STR:RIGHT:LEFT\$: LEN:MID\$: VAL: CSAVE: CLOAD:

READY BUILT AND TESTED £250.00: KIT FORM £225.00

NASCOM IMP: PLAIN PAPER PRINTER:60 LINES PER MINUTE:80 CHARACTERS PER LINE BIDIRECTIONAL:800 CHARACTER BUFFER:96 CHARACTER ASCII:110-9600 BAUD:

RAM BOARDS

READY BUILT AND TESTED £325.00 EXPANSION MEMORY BOARD TYPE 'B' CAN HOLD UP TO 48K RAM

READY BUILT AND TESTED WITH:

16K £175.00 KIT FORM £165.00

RAM BOARD TYPE 'A'

BUILD £150.00 KIT £140.00

PIO BOARDS

1.0 BOARDS CAN HOLD UP TO 3PIO X3 ART, ICTC, SUPPLIED WITHOUT MAJOR DEVICES. READY BUILT AND TESTED £55.00: KIT FORM £45.00: PIO KIR £12.00: CTC KIT £14.00: UART KIT INCLUDES XTAL & BAND RATE GENERATOR £16.00. PLEASE ADD £1.50 PER ITEM P&P, PLUS 15% VAT.

V&T ASSEMBLER

New improved V&T Assembler now available for Nascom 1 & 2.

The only fully relocatable assembler for the Nascom range - (easily converted to other Z80 systems).

- Supports all standard mnemonics & pseudo ops: - DEFB, DEFS, DEFW, DEFM, EQU & ORG. Source, object & symbole areas fully programmable.

Now includes —

Symbole table
Operation under T2, T4, B Bug, Nasys
Label find & change
Relocating source reader
Improved keyboard routine, etc.

£12.50 + VAT

**V&T ELECTRONICS 82 CHESTER RD., LONDON N.19 5 BZ
01-263 2643**

• Circle No. 132

KATANNA MANAGEMENT SERVICES LTD

(In association with S.J. Trott Ltd)

K
M
S

22 Roughtons
Galleywood
Chelmsford
Essex, CM2 8PF
Tel: (0245) 76127

We are at the 1980 Microcomputer Show at the Wembley Conference Centre, 22, 23, 24th July on Stand 10.

On show we shall have the TANDY TRS-80 microcomputer, both the famous world beating MODEL I and the new MODEL II.

We shall be demonstrating various business packages including Stock control, Sales ledger, Purchase ledger, Nominal ledger, Payroll and Word processing.

We shall also be operating some educational packages; including specially written lessons to teach "Basic" programming on the TRS-80 microcomputer.

TANDY PRICES

TRS-80 4K level I	£385.25
TRS-80 4K level II	£469.20
TRS-80 16K level II	£546.25
TRS-80 16K level II (keyboard only)	£439.00
TRS-80 Model II (32K)	£2,298.85
TRS-80 Model II (64K)	£2,586.35

TEAC Disc Drive

Single disk drive	£287.50
Dual disk drives	£506.00

(These disk drives are designed to run on the TRS-80 Model I).

All the above prices include V.A.T.

SOFTWARE

Sales ledger	£225 plus VAT
Purchase ledger	£225 plus VAT
Stock control	£200 plus VAT
Payroll	£218 plus VAT
Invoicing	£ 75 plus VAT
Nominal ledger	£325 plus VAT

(These packages are provided by TRIDATA MICROS LTD)

Scriptfit (word processing)	£69.95 inc. VAT
Level I programming course	£ 7.95 inc. VAT
Level II programming course (beginners)	£ 8.95 inc. VAT
Level II programming course (Advanced)	£11.95 inc. VAT

Why not come and discuss your Business and Education requirements with Katanna at the 1980 Microcomputer Show. Even if you can't make the show we can help you. Just fill in this coupon if you wish to order any of the above products or circle the enquiry number for further details.



Name Position
Company
Address
Telephone No. Home
Please forward the following goods.
I enclose £.....

PC7

**MICROTEK
COMPUTER SERVICES**

for

IMS 5000, 8000

and

NORTH STAR HORIZON

We have many software packages for these machines, including Stock Control, Accounting, Payroll, Word Processing and Mailing. However, if you are fed-up with looking at standard packages then why not let us design and write a system specially for YOU! If you are interested, contact:

**John Rothwell
on
Orpington 26803 or write
to 50 CHISLEHURST ROAD,
ORPINGTON, KENT**

• Circle No. 134

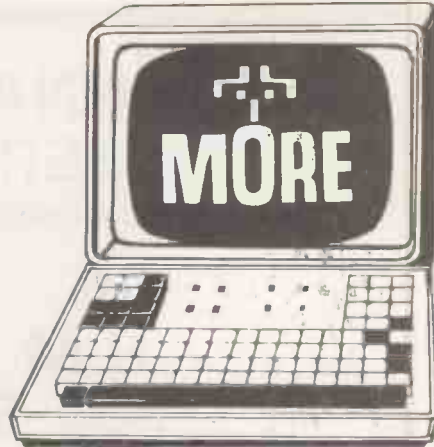

If your PET is hungry for 5¼" flexible disks, we can feed him.

Control Dataset high quality 5¼" flexible disks are readily available at major office equipment suppliers. Or you can order them direct from us.

For a list of stockists, or details of our mail order service, contact us at Control Dataset Ltd., P.O. Box 16, Argyle Way, Stevenage SG1 2AB, Herts. (Tel: 0438-3399)

**CONTROL
DATASET**

CONTROL DATA

• Circle No. 135

Introducing the

**INFODISK FILE MANAGEMENT SYSTEM FOR THE
COMMODORE COMPUTER SYSTEM**

At last a program system that will do what you want, the way you want it, at a remarkably low price. There is no need to buy separate programs for each application. The one system enables you to create an unlimited number of applications. Do all your accounting, stock control, payroll, file management and information retrieval etc., the way you understand, with this one system, for one price. It is possible to do almost all conceivable business applications with this simple to use system.

It features among other things:—

- 1.) Data validation — 8 data types.
- 2.) Variable length fields and records of any size.
- 3.) Automatic calculations and updating of individual fields, records and whole file.
- 4.) Linear and tabular reports of all kinds, for all records satisfying any conditions.
- 5.) Powerful search capability; numeric; alphabetical and date comparisons, conditional expressions however complex whatever you want 'INFODISK' can find it.
- 6.) Sort facilities to sort files in any order or any field.

'DISK' £130.00p. + V.A.T. plus 50p. Packing & Postage
for 16 and 32K Computers.

'TAPE' £ 40.00p. + V.A.T. plus 50p. Packing & Postage

MAIL ORDER — CHEQUE WITH ORDER TO:—

A.J.R. OFFICE EQUIPMENT SERVICES LIMITED.
5 CHURCH DRIVE, DAYBROOK, NOTTINGHAM, NG5 6.

Please supply Item

Quantity

Name

Address

PC7

• Circle No. 136

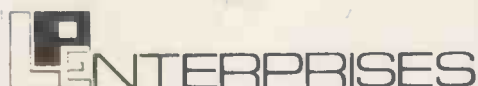

L.P. Enterprises,
 Room PC
 11 Cambridge House
 Cambridge Road
 Barking, Essex IG11 8NT
 01-591 6511

**EUROPE'S LARGEST SELECTION OF MICROCOMPUTER BOOKS, MAGAZINES AND SOFTWARE FOR
 THE HOBBYIST, EDUCATIONALIST, PROFESSIONAL AND RETAILER**

FOR THE NOVICE

From the Counter to the Bottom Line	£10.00
Your Home Computer	£ 5.95
Introduction to Personal and Business Computing	£ 4.95
Getting Involved with Your Own Computer	£ 4.75
How to Profit from Your Personal Computer	£ 5.50
Microcomputer Potpourri	£ 2.40
Hobby Computers are Here	£ 3.95
New Hobby Computers	£ 3.95
Understanding Microcomputers and Small Computer Systems	£ 6.75
Understanding Microcomputers and Small Computer Systems and Audio Cassette	£ 8.75

FOR FUN

SARGON — A Chess Game	£ 9.50
BASIC Computer Games	£ 5.00
More BASIC Computer Games	£ 5.50
What to do After you Hit Return	£ 8.95
8080 Galaxy Game	£ 6.95
SUPER — WUMPUS — A game in 6800 Assembler & BASIC	£ 4.25
Computer Music Book	£ 6.75
Computer Rage (A board game)	£ 6.95
Artist and Computer	£ 3.95
Games, Tricks and Puzzles for a Hand Calculator	£ 2.49
Introduction to TRS-80 Graphics	£ 5.75
Take My Computer Please... (Fiction)	£ 3.25
Introduction to Low Resolution Graphics	£ 5.50

CONCERNING LANGUAGE

SCELBAL — High Level Language Plus Supplements	£15.00
Instant BASIC	£ 6.95
Basic BASIC	£ 6.50
Advanced BASIC	£ 6.00
Users Guide to North Star BASIC	£10.00
A Practical Introduction to PASCAL	£ 3.95
Microsoft BASIC	£ 6.50

FOR THE 6502

32 BASIC Programs for the PET	£10.00
6502 Software Gourmet Guide & Cookbook	£ 7.15
Best of Micro, Vol 1	£ 5.50
Best of Micro, Vol 2	£ 5.50
Programming the 6502 (Zans)	£ 7.95
Programming the 6502 (Foster)	£ 6.75
6502 Applications	£ 7.95
6502 Assembly Language Programming	£ 8.25
The PET and the IEEE 488 (GPIB) bus	£ 9.95

GENERAL

See Magazines and Subscriptions! See Osborne Books!

Microprocessors from Chips to Systems	£ 7.00
Microprocessor Interfacing Techniques	£ 8.75
Numbers, in Theory and Practice	£ 5.95
Cheap Video Cookbook	£ 4.30
CMOS Cookbook	£ 7.50
IC OP-AMP Cookbook	£ 8.95
RTL Cookbook	£ 4.25
TTL Cookbook	£ 7.50
Ciarcias Circuit Cellar	£ 5.50
First Book of Kim	£ 7.00
Buyers Guide to Microsoftware	£ 2.40
Calculating with BASIC	£ 4.95
Computer Programs that Work (In BASIC)	£ 2.95
BASIC Software Library: (Listings)	
Vol 2: Maths, Engineering and Statistical Programs	£17.50
Vol 3: Advanced Business Programs	£26.95
Vol 5: Experimenters Programs	£ 7.95
Vol 6: Miniature Business System	£32.50
Vol 7: Chess/Medbil/Wdproc. Programs	£26.95
Vol 8: Homeowners Programs	£14.05
Best of Interface Age: Software	£ 9.95
Bar Code Loader for 6800, 8080, Z80 and 6502	£ 1.75
Best of BYTE	£ 8.95
Scelbi BYTE Primer	£ 8.95
Best of Creative Computing, Vol 1	£ 6.95
Best of Creative Computing, Vol 2	£ 6.95
Program Design	£ 4.25
Programming Techniques: Simulation	£ 4.25
PIMS — A Database Management System	£ 5.95

HOW TO PURCHASE

Send cash, cheque, PO or credit card no. to L.P. Enterprises, Room PC, 11 Cambridge House, Cambridge Road, Barking, Essex IG11 8NT. 01-591 6511. All payment must be in sterling and drawn against a UK bank. The titles specified here are but a small selection of our range. For the complete list, send an SAE to the above address, or come and visit our showroom (open during office hours).

ITT world-wide technology available locally from Telefusion.



The famous ITT 2020 Micro Computer is now available nationwide from Telefusion. Ideal for most small and medium-sized businesses, it's one of the most versatile and cost-efficient computers you can buy. And now it's easily available from Telefusion and their agents.

The ITT 2020 can be teamed up with matching Floppy Disk Drive Unit and Serial Printer. In other words, it can be made into a complete data processing system.

Why not contact us or one of our dealers listed below for a complete demonstration. Alternatively, an 'on-site' demonstration can be arranged through our central Micro Computer Sales Office. Call Alan Webb, Bristol (0272) 211446.

ITT 2020 Micro Computer is a complete self-contained, ready-to-use computer. Standard features include: *PALSOFIT and monitor in ROM. *Colour graphics.

*Sockets for up to 48k bytes RAM. *Cassette interface. *Typewriter-style ASCII keyboard. *High-efficiency switching power supply and rugged structural foam case.

The ITT 2020 Micro Computer video display circuiting section displays memory as text, colour graphics or high resolution graphics—software selectable. Both graphics modes can be selected to include four lines of text at the bottom of the display area. In either graphics mode the user can select (under software control) one of two memory pages to be displayed.

See it for yourself, you'll be impressed.

Telefusion

Authorised Dealers: Demacan Ltd., 2 West Priory Close, Westbury on Trym, Bristol. Tel: 621920. Aries Business Machines, 21 Manor Walk, Thornbury, Bristol. Tel: 416189. Farmplan, Netherton Farm, Ross-on-Wye, Herefordshire. Tel: 4321. Ensign, 13-19 Milford Street, Swindon. Tel: 42615. Radan Computational Ltd., 19 Belmont, Bath. Tel: 318483. Data Lease Consultants, The Manor Court House, 9 Fore Street, Chard, Somerset. Tel: 5539. Guestel Ltd., Refuge House, 2-4 Henry Street, Bath. Tel: 65379. Brindwell, 13 Brockridge Lane, Frampton Cotterell, Bristol. Tel: Winterbourne 774564. Data Link Micro Computer Systems, 10 Waring House, Redcliff Hill, Bristol. Tel: 213427. Dolphin Computer Sales Ltd., 17 Market Place, Tetbury, Glos. Tel: 53195. Data Wright Computer Services, 10 The Drive, Gosforth, Newcastle-upon-Tyne. Tel: 20946. Micro Business Centre, Castlebridge House, Lichfield Road, Wolverhampton. Tel: 732375/6/7. Or contact the Commercial Sales Manager at Telefusion: Dudley Street, Sedgley, West Midlands. Tel: 75961. Atlas Chambers, King Street, Leeds. Tel: 450453. 63 London Road, Norwich. Tel: 28441. 45 Church Road, Hove, Sussex. Tel: 723114. 61 Queens Square, Bristol. Tel: 211446. 35 Hoghton Street, Southport. Tel: 31030.

• Circle No. 141

COMPUTERS FOR HOME BUSINESS EDUCATION

WIDE RANGE OF ELECTRONIC GAMES

Exidy Sorcerer

8K - £747.50 16K - £874.00 32K - £987.75

S100 Expansion Box 6-slot - £241.50

Micropolis Dual Disc Drive - £1,380.00

Centronics 779 Printer - £920.00

Z-89 ALL-IN-ONE COMPUTER

The new all-in-one computer from Zenith is the most versatile micro-computer available today.

• 'Intelligent' video terminal • two Z80 microprocessors • floppy disc storage system • expandable to 48K RAM
Easy to programme. Simple to operate. It is capable of a multitude of high-speed functions and speaks the language of today's most popular software. Price from £1805



The most advanced microcomputer yet.

WH-14 SERIAL PRINTER
With a compact table-top configuration, the WH-14 is designed for a broad variety of uses in any computing environment.

Microprocessor based, it is compatible with any computer providing standard RS-232C or 20mA current loop interface connections. Price £586.50



5 1/4 FLOPPY DISK for TRS 80
Teac F d 1 d A Single Drive £287.50
Dual Drive £506.00
Integral Power Supply



Video 100
17" BLACK & WHITE LOW COST WOOD MONITOR
£90.00

RADAT 5" 10 MHz Scopes only £169.00
SELECTION OF SOFTWARE GAMES & BUSINESS

TRS80 LEVEL 2 16K
ONLY £440 K&BD ONLY
EXPANSION BOX 32K £340.00

Large range of computer etc. books. Send for List SAE with all enquiries - All prices inclusive.

SUPPLIERS TO BUSINESS, EDUCATION & HEALTH AUTHORITIES



N.I.C.

61 Broad Lane, Tottenham, London N15.
01-808 0377



• Circle No. 142

Own your own microcomputer store

ComputerLand - the world's leading micro-computer retailer with over 100 stores worldwide - offers you a unique opportunity to run your own computer store.

Interested?

ComputerLand can offer you a franchise to sell the best names in small computers, peripherals and software packages. We deliver the products to you at manufacturers' prices, which allows you to sell them at the highest profit margins.

As a ComputerLand store owner, you will be backed by the experience and resources of the largest, most successful retail chain in the business. The results: ComputerLand store owners doubled their sales last year and are continuing at that rate this year.

If you are interested in learning more about starting your own microcomputer store, contact us.

ComputerLand®

EUROPE S.à.r.l.

8, rue Jean Engling, Dommeldange (Luxembourg)

Phone: 43 54 55 · Telex: 24 23

No connection with Computerland Ltd nor any stores operating under the name Computerland in the UK.

WEBER & CO

• Circle No. 143

DYAD Developments are pleased to

announce that they have been appointed UK Distributors of

COMPUCOLOR II

The Compucolor Corp. are now supplying them with their up to date systems and these have been found to be exceptional in performance and reliability. These second generation machines represent the most sophisticated and powerful small computers available today and at only half the cost of their counterparts.

WHAT YOU GET

13" colour video monitor
Built in disc drive
RS232C port, selectable Bdr
High resolution graphics
Two character sizes
Extended Basic with DOS
Vector plotting
And much more

Typical Prices

8K User RAM	£ 998
16K	1078
32K	1198
Additional Disc Drive	310
Soundware (music)	30
Assembler	15
Text Editor	15

DEALER INQUIRIES WELCOMED prices excl.VAT



The Priory - Great Milton - Oxon - OX9 7PB - Tel (08446) 729

• Circle No. 144

What will you do with 12-year-old programmers when they reach 16?

Any microcomputer is a major investment for an educational establishment. Many potential users feel that a BASIC only computer is ample for their needs. That may be fine today, but with computer education starting so early you may in a surprisingly short time find you want more than current implementations of BASIC.

The 380Z is a computer that can grow to match your needs.

In the design of the 380Z our target user is the graduate research scientist. This ensures that the expandability and versatility needed tomorrow has been provided for in the computer you buy now.

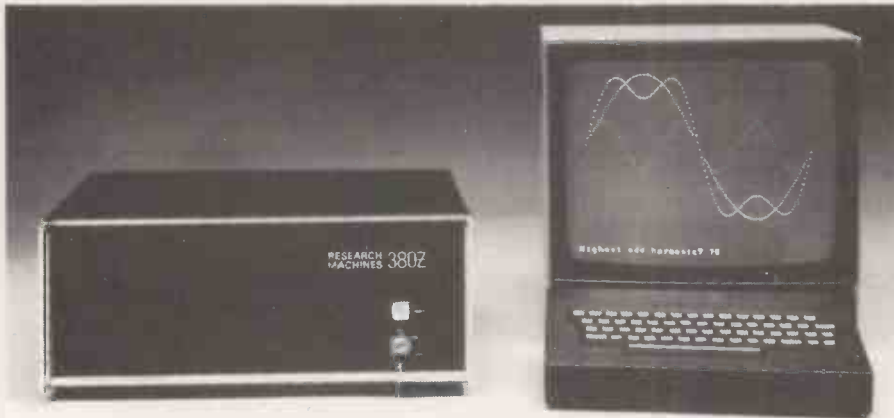

Might you want to add disc storage in the next few years?

If you do:

Given good hardware, software availability completely determines the flexibility and usefulness of your system. There is absolutely no question that a Z80 based micro-computer which uses the industry-standard CP/M* disk operating system has several times more software on the market available to it than non CP/M computers.

Today you can purchase a mature CP/M BASIC, FORTRAN, COBOL or Text Processor for the 380Z. Soon there will be CP/M Pascal and Database Management systems.

CP/M software is several years ahead of software available for non CP/M family machines.

If you don't:

Remember that professionals writing packages for your cassette system will themselves often use a disk 380Z, and the power of their tools will influence what they produce.

For many people a disk machine is too expensive – but at least the 380Z

approach will allow your students to advance.

380Z BASIC is not frozen in ROM. An enhanced BASIC could be loaded in mid 1980 and a BASIC with structured features sometime later.

On the 380Z the memory used by a BASIC interpreter can also be used for other software.

Does our research-oriented design pay off in classroom hardware?

Our scientific graphics was produced for the professional user. Interest in it for classroom use has been surprising.

The 380Z has the best graphics now available on a microcomputer,

allowing multiple resolutions, multiple paging, fading and accurate control over colour. All these features help bring excitement to efforts in computer assisted learning.

Our standard machine comes with low resolution graphics and support for this from BASIC allows you to plot a point directly with a plot command – useful for training and teaching.

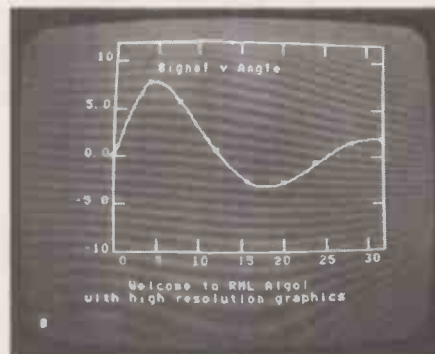

It is worth remembering too that neither our low resolution graphics nor our optional scientific (high resolution) graphics has any limiting effect on your memory usage, and in both you can



freely mix upper and lower case text and diagrams.

Mains noise can cause system crashes which result in loss of programs and data. All current 380Zs include a mains filter which significantly reduces the chances of this happening.

Don't buy a 380Z on patriotic grounds.

Please only buy it if you would have bought it anyway. But remember, because it is designed and manufactured here you are bound to have better access to us for influence and help than if we were on the other side of an ocean.

Prices range from a 16K cassette 380Z @ £897 to a 56K Dual Full Floppy Disk 380Z @ £3322.

LOWER COSTS

Three things have happened which make it easier to buy a 380Z.

ONE: From 1st November 1979 most prices have been reduced.

TWO: Schools and some colleges can now get a 5% discount on computer orders.

THREE: A new Local Authority quantity discount scheme has been introduced to make it easier for more users to benefit from quantity purchasing.

Please contact the Sales Office for details.

RESEARCH MACHINES

RESEARCH MACHINES Ltd,
PO. Box 75, Mill Street, Oxford, England.
Telephone: Oxford (0865) 49791/2/3.
Please send for full sales information.
Prices do not include shipping costs or VAT @ 15%.

*Trademark. Digital Research.

Come and see us on Stand 17 at the 1980 Microcomputer Show
Wembley Conference Centre 22-24 July.

TOMORROW TODAY

at
Birmingham Computer Centre

Commodore official distributors



NEW LOW PRICE

FROM £425

3016, 3032, 3008 PETs
The reliable value for money system with after sales support, instruction and training facilities and a wide range of programmes.

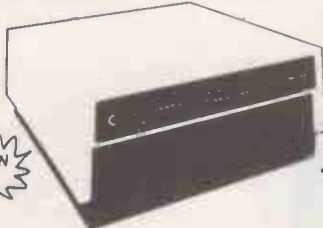

NEW LOW PRICE

FROM £695

3040 DUAL DRIVE FLOPPY DISC
The latest in disc technology. Low cost with reliable data transfer.

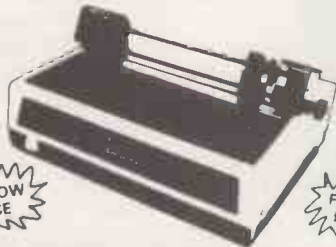

NEW LOW PRICE

FROM £375

3022 PROFESSIONAL PRINTER
The high specification printer. Prints all PET characters onto paper and accepts labels, printed forms, cheques etc.

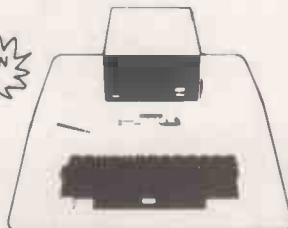

NEW LOW PRICE

48K DISK DRIVE WITH CONTROLLER
£1044

Apple authorised distributors
The sophisticated quality system with a reputation for advanced design and innovation.

**Camden Electronics, First Floor,
462 Coventry Road, Small Heath,
Birmingham B10 0UG.**
Telephone 021 773 8240

Open Mon.-Sat.
9.30-6.00 p.m.



• Circle No. 146

SOFTY Software Development System AND EPROM PROGRAMMER

EX-STOCK

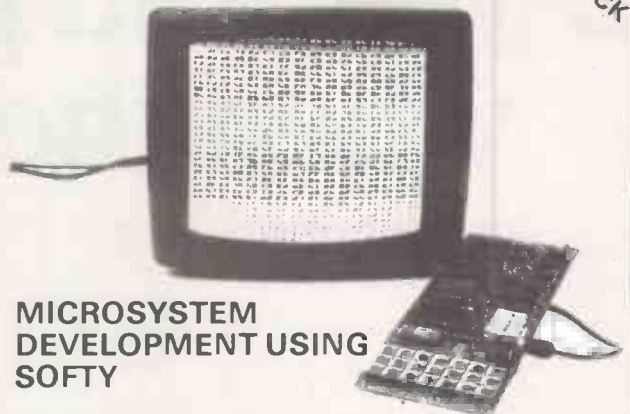

MICROSYSTEM DEVELOPMENT USING SOFTY

SOFTY is intended for the development of programs which will eventually become software residing in ROM and forming part of a microsystem. During the development stage of a microsystem, SOFTY will be connected in place of the firmware ROM via a ribbon cable, terminated in a 24 pin DIL plug. Data may be entered into the SOFTY RAM via the serial port, parallel port, direct memory access, or the keypad, and manipulated using the assembler key-functions. When the program has been entered, and the internal microprocessor can be 'turned off', and the external microsystem and its resident microprocessor allowed to access and run the program in SOFTY's RAM and/or programming socket. In this way, modification can be made until the required program is complete — the contents of the RAM being clearly visible as a 'page' on TV or monitor. 4 pages are available, 2 of the Data RAM and 2 of the programming socket. In the end, when the program is complete and working, the DIL plus is removed and replaced by an EPROM device programmed by SOFTY. SOFTY is able to program the 2704/2708/2716 family which have 3 voltage rails — To help in the process of program development SOFTY has various assembler key-functions, which include — block shift without overwriting, block store, cursor control, match byte and displacement calculations (for jumps etc). A high speed cassette interface is also provided for storing working programs and useful subroutines. SOFTY Kit-of-parts: (including zero insertion force socket for EPROM programmer) Price £115 (inc VAT, p&p). SOFTY built and tested — £138:00 (inc VAT, p&p). Built SOFTY power supply — £23:00 (inc VAT, p&p). Write or telephone for full details.

NEW

SOFTY CONVERSION CARD — EX-STOCK
Enables SOFTY to program the single rail EPROMs 2508, 2758, 2516, (INTEL 2716), 2532. Selection of device type and 1K block are by 4 way pcb slide switches. Programming socket is zero insertion force. Supplied ready built & tested with Dip jumper for connection to SOFTY. £46:00 (inc VAT, p&p).

NEW

SOFTY PRINTER CARD — EX-STOCK
• 40 column electrosensitive printer • 5 x 7 dot matrix
• software selection of characters per line (1 to 16 bytes)
• push button printing of EPROM/RAM/Intercursor contents
• Connects to SOFTY card edge • Well documented • Supplied ready built & tested, including power supply, edge connector & paper roll for £166:75 (inv VAT, p&p) Spare paper rolls (28-30metres/roll) — £8:00 (inc VAT, p&p).

MODEL 14 EPROM ERASERS

EX-STOCK

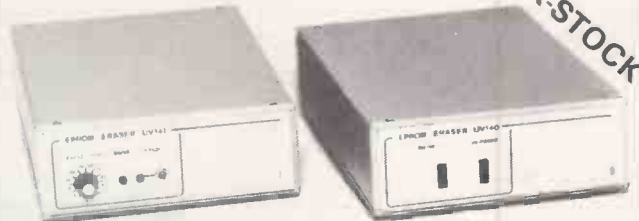

MODEL UV 141 EPROM ERASER
• Fast erase times (typically 20 minutes for 2708 EPROM)
• 14 EPROM capacity
• Built-in 5 to 20 minute timer to cater for all EPROMs
• Safety interlocked to prevent eye and skin damage
• Convenient slide-tray loading of devices
• 'MAINS' and 'ERASE' indicators
• Rugged construction
• Priced at only £89.70 (inc VAT, p&p)

MODEL UV 140 EPROM ERASER
Similar to Model UV141 but without timer
Low price at only £70.73 (inc VAT, p&p)
WRITE OR TELEPHONE FOR FULL DETAILS OR SEND CHEQUES/OFFICIAL COMPANY ORDERS TO:

GP Industrial Electronics Limited

Skardon Works, Skardon Place, North Hill, Plymouth
PL4 8HA. Telephone: Plymouth (0752) 28627
TRADE AND EXPORT ENQUIRIES WELCOME

• Circle No. 147

SUPERBRAIN™

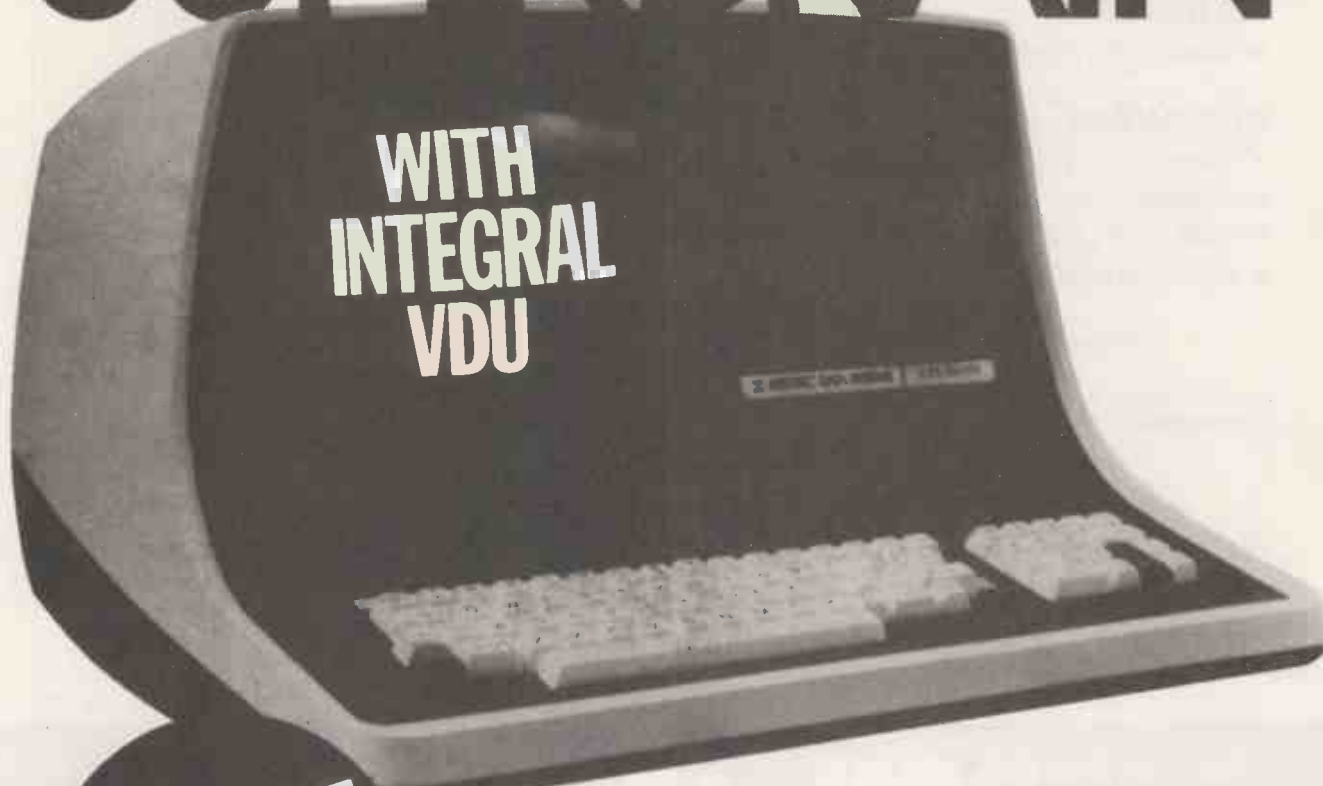

£1,995
COMPLETE
(+VAT)

★ Full 64K RAM

★ Twin Z80A microprocessors

★ CP/M™ (2.2) operating system

★ Twin double density mini floppies (320K:670K optional)

SUPERBRAIN™ -stand alone system and intelligent terminal combined in a single desk top unit (14³/₈''H×21³/₈''W×23¹/₈''D).

Non-glare dynamically focused 12'' CRT and Universal RS-232

Communications port. SOFTWARE PACKAGES AVAILABLE.

Full **SUPERBRAIN™** details from the following dealers:

JAEMMA LTD.,
44 Manor Park Road, Castle Bromwich,
BIRMINGHAM Tel: 021 7474531

JENNINGS COMPUTER SERVICES LTD., 55/57 Fagley Road,
BRADFORD 2, W. Yorks.
Tel: 0274 637867

COMPUTERISED BUSINESS SYSTEMS, 32/34 Huntriss Row,
SCARBOROUGH, N. Yorks.
YO11 2ED. Tel: 0723 78787

AERCO GEMSOFT,
27 Chobham Road, WOKING,
Surrey GU21 1JD. Tel: 04862 22881

O.C.T., Kimberley House,
Vaughan Way, LEICESTER,
LE1 4SG. Tel: 0533 28631

MICRO BUSINESS SYSTEMS,
E Floor, Milburn House, Dean Street,
NEWCASTLE-ON-TYNE, NE1 1LE.
Tel: 0632 29593

CULLOVILLE LTD., Thornfield,
Woodhill Road, Sandon,
CHELMSFORD, Essex.
Tel: 024 541 3919

PROMGLOW LTD., 12 Dene Road,
New Southgate, LONDON N11 1ES.
Tel: 01-368 9002

SHEFFIELD COMPUTER CENTRE,
225 Abbeydale Road, SHEFFIELD,
S7 1FJ. Tel: 0742 53519

COSMOS COMPUTERS LTD.,
Blackhorse Road, LETCHWORTH,
Herts. Tel: 046 26 6861

BORDER COMPUTING,
Dog Kennel Lane, BUCKNELL,
Shropshire SY7 0AX. Tel: 05474 368

DAYTA, 20B West Street,
WILTON, Wilts. SP2 0DF.
Tel: 072274 3898

MICRO SOLUTION LTD.,
Park Farm House, Heythrop,
CHIPPING NORTON, Oxfordshire
OX7 5TW. Tel: 0608 3256

MICROPEOPLE LTD.,
Microcomputer Consultancy Services,
1 Union Street, LONG EATON,
Nottingham, NG10 1HH.
Tel: 06076 68923

OMEGA ELECTRICS LTD.,
Flaxley Mill, Flaxley Road,
MITCHELDEAN, Gloucestershire.
Tel: 045 276 532

AMA (COMPUTING) LTD.,
1 Frog Hall Lane, WARRINGTON
WA2 7JJ. Tel: 0925 33137

ROGIS SYSTEMS LTD.,
Keepers Lodge, Frittenden,
Nr. CRANBROOK, Kent.
Tel: 058 080 310

GARCIA BUSINESS SYSTEMS,
106 High Street, BUSHEY, Herts.
WD2 3DE. Tel: 01-950 6255

ESCO COMPUTING LTD.,
74 Waterloo Street, GLASGOW,
G2 7DA. Tel: 3041 204 1811

For dealer enquiries, contact

ICARUS COMPUTER SYSTEMS LTD., 27 Greenwood Place, London NW5 1NN.

SUPERBRAIN™ is the registered trademark of Intertec Data Systems.

CP/M™ is the registered trademark of Digital Research.

• Circle No. 148

GATE MICROSYSTEMS LIMITED

SCOTLAND'S COMPLETE MICROCOMPUTER SERVICE



now supply and support:—

HARDWARE:

- Apple II Systems and Peripherals

- Commodore Business Systems
- A wide range of VDU's, printers etc.

SOFTWARE:

- Incomplete Records Accounting
- Sales Ledger
- Purchase Ledger
- Nominal Ledger

- Stock Control
- Payroll
- Word Processing
- Database

Software can be tailored to your requirements or written to your specifications

Our service is complete, ranging from advice on system selection through installation and implementation, to operator training and comprehensive hardware and software maintenance.

You don't have to take our word for it. Call us and arrange a demonstration.

GATE MICROSYSTEMS LIMITED
THE NETHERGATE CENTRE, 66 NETHERGATE, DUNDEE
TEL: (0382) 28194

• Circle No. 149

DATRON of SHEFFIELD



**CIVIL ENGINEERING
PACKAGES
NOW AVAILABLE**



SHARPMZ-80K Home Computer

See it in operation
and buy it at DATRON
Demonstrations.

9am - 5pm Monday - Saturday.

Call anytime - no obligation
or by mailorder.

HP/Leasing Available

Delivery free anywhere in the U.K.

DATRON MICRO CENTRE
DATRON INTERFORM LTD

2 Abbeydale Road, Sheffield S71FD.
Telephone: 0742-585490, Telex: 547151.

• Circle No. 150

60 CHARACTERS PER SECOND

RICOH RP-1600 THE FASTEST DAISY WHEEL PRINTER. £1290 FAST, heavy duty commercial DAISY WHEEL printer, with high quality printout, coupled with low noise necessary for office environment. Nationwide service by NEXOS. 90 day warranty provided at your premises. 124 char: upper/lower case. * 10/12 chars: per inch giving 136 or 163 columns. * 15 inch wide friction platen. * /reverse Top of the form, BOLDING, underline, and host of other features. * Centronics type parallel interface as standard. Options: serial interface £60 * PET interface £65 * APPLE interface £75.



ANADEX DP-8000
NEW LOW PRICE £475.
Fast 112 Characters per second. * Both RS-232, and Centronics Parallel interfaces built in * Upper/lower case L sign.



NEW TRS-80 MODEL 1 48K SYSTEM
WITH DUAL DISC DRIVES. £1250.
NEW GREEN SCREEN VDU, WITH ROCK STEADY DISPLAY, REDESIGNED 32K EXPANSION INTERFACE WITH TROUBLE FREE DISC OPERATION, TWO 40 TRACK TEAC DISC DRIVES, COMPLETE WITH CABLES, TRIDATA SALES, PURCHASE, INVOICING, PAYROLL PACKAGES AVAILABLE

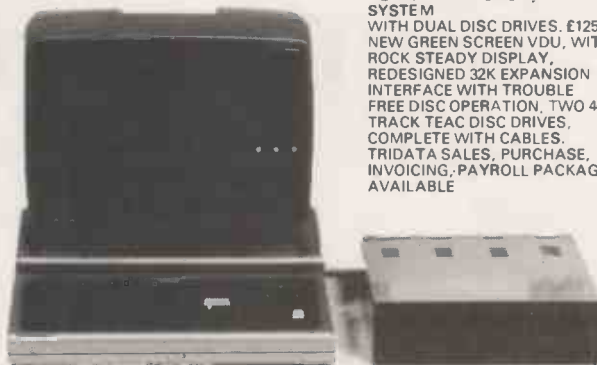

LOW COST WORD PROCESSOR I
BASED ON TRS-80 LEVEL 2 16K, CASSETTE RECORDER, ELECTRIC PENCIL SOFTWARE, UPPER/LOWER CASE MOD, PRINTER INTERFACE AND OKI DOT MATRIX PRINTER. COMPLETE READY TO GO £1095. FREE MAILING LIST PROGRAM.

WORD PROCESSOR II
SAME AS ABOVE BUT WITH 48K, 2 DISC DRIVES AND RICOH DAISY WHEEL PRINTER. £2575.

WORD PROCESSOR III
BASED ON SUPERBRAIN COMPUTER SHOWN ABOVE. WITH RICOH PRINTER AND "MAGIC WAND" THE ULTIMATE IN WORD PROCESSING. LETTERS AUTOMATICALLY FORMATTED WITH ADDRESSES FETCHED FROM SEPARATE FILE. COMPLETE SYSTEM. £3395.
INVOICING, STOCK CONTROL, SALES LEDGER, PURCHASE LEDGER, PAYROLL AVAILABLE FOR ABOVE COMPUTERS. FROM £250 PER PACKAGE.
Prices quoted above do not include VAT. Phone or call for further details or demonstrations.

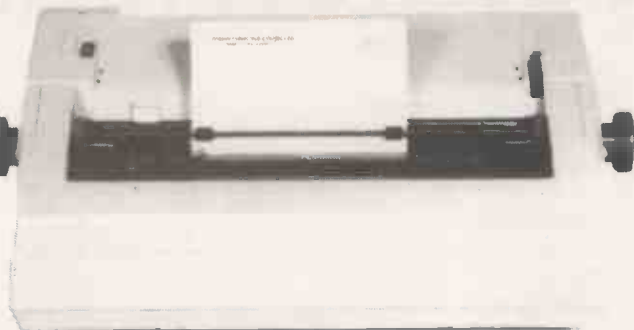

OKI MICROLINE 80/132. The quiet printer you can live with £495. The quietest Dot Matrix available. 40,80, or 132 cols per line. * excellent print quality * 3-way paper handling: Letterheads, Fan-fold, or Paper Rolls * Graphics * Ideal for software written for large 132 col printers * Continuous rating printing day in and day out * Centronics parallel standard. Options: RS-232, PET, APPLE. Dealer Enquiries invited.

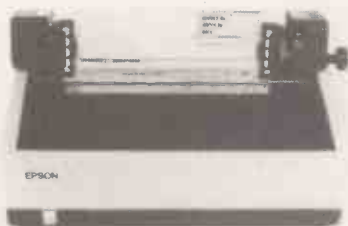

EPSON TX-80 £395
Dot-Matrix Printer with PET Graphics. Prints 80 columns on plain paper at 90 characters/second. Adjustable tractor * Upper/lower case * Double width printing * Micro controlled * Self test * Heavy Duty Print Head using Jewell Bearings for long life * Made by Shinshu Seiki an affiliate of Seiko Watch Co of Japan. Interface: Centronics Parallel. Options: PET, APPLE and Serial.

NEW SUPERBRAIN £1875.
Now with CP/M 2.2, and increased disc storage. Twin Z80-A 4MHz. * 2 Double Density Disc Drives, giving 320K storage * 64K RAM. * High resolution 12 inch crt. 80 x 24 lines upper/lower case * 2 RS-232 printer ports. * CPM 2.2 operating system. * MBasic, Cobol, Fortran, Pascal, Word Processing and Accounts packages available. Ealer Enquiries Invited.

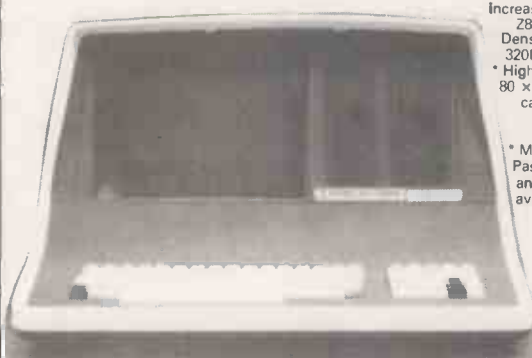

TRS-80 MODEL II £1999
State of The Art Second Generation Computer. Over 10,000 already sold in USA. 8 slot bus ensures expansion of hard discs and other peripherals. 76 Key professional keyboard, self test on power up. TRSDOS and Level III Basic Standard. CP/M available as option, making a wide range of accounting, educational, scientific and word processing packages instantly usable. Nationwide service through 180 Tandy Stores and Computer Centres.



LONDON COMPUTER CENTRE LTD
43, GRAFTON WAY,
OFF TOTTENHAM COURT ROAD,
LONDON W.1.
TEL 01-388 5721
OPENING HRS: 11-7 MON-FRI, 12-4 SATS.

NORTHERN DEALER
MICRO SYS LTD
58 HIGH STREET
PRESCOTT
MERSEYSIDE
TEL: 051-426 7271

MIDLANDS DEALER
HORIZON SOFTWARE LTD
REGENT HOUSE
16 WEST WALK
LEICESTER LE1 7NG
TEL: 0533 556550

FARMPPLAN COMPUTER SYSTEMS

HARDWARE

16k I.T.T. 2020 Microcomputer	£650
16k R.A.M. Upgrade kit	£60
Disk Drive and controller	£350
Parallel Printer Interface card	£95
Anadex Printer	£525
Numeric Key Pad	£75
Music Composer	£120

STATIONERY

5 1/4" Verbatim Disks	£2.50 ea
Box Printer Paper	£13.60 per box

Other stationery available upon request

Full range of Mountain Hardware products

ALL MACHINERY EXCEPT PRINTER (3 MONTHS)

GUARANTEED FOR 12 MONTHS

SOFTWARE

Agricultural Package	£2565
Desk Top Management (Financial analysis)	£125
Visi-Calc (Problem solving)	£95
Rent Master	£250
Word Processor	£125
Payroll	£200
Data Base	£125
Quotation System	£350

Games & Utility Disks Vols. 1-6	£20 ea
Documentation Utility Disk	£50

IMPORTANT We now have available — controller cards for 8" Drives, I.B.M. compatible, suitable for Apple/I.T.T. Price on application

ORDERING INFORMATION:

Delivery/Insurance extra. All prices exclude V.A.T. at 15%

Price list correct at time of publishing, subject to change without notice.

FARMPPLAN, NETHERTON, ROSS-ON-WYE, HEREFORDSHIRE TEL. Ross 4321

Offices also at Melton Mowbray, Northallerton, Aberdeen

• Circle No. 152

TRS-80 OWNERS!

LEVEL II CASSETTE

ADVENTURE (LAND)*	£ 7.50
ADVENTURE (PIRATES)*	£ 7.50
AIR RAID*	£ 7.50
AMAZIN' MAZES	£ 4.00
BACKGAMMON	£ 4.00
BALLOON RACE	£ 5.00
BARRICADE*	£ 7.50
BASEBALL	£ 4.00
BATTER UP	£ 3.00
BINGO	£ 3.00
BOWLING (TEN PIN)	£ 4.00
BREAKAWAY	£ 3.00
BRIDGE CHALLENGER	£ 7.50
DOGSTAR	£ 5.00
END ZONE	£ 4.00
FASTGAMMON*	£ 7.50
GALACTIC BLOCKADE	£ 4.00
HAMURABI	£ 3.00
HANGMAN	£ 3.00
KAMIKAZE	£ 4.00
KENTUCKY DERBY	£ 3.00
LUNAR LANOER	£ 4.00
MASTERMIND*	£ 4.00
MICROCHESS*	£ 10.00
MISSION IMPOSSIBLE*	£ 7.50
OTHELLO III	£ 3.00
PENTOMINOES	£ 5.00
PORK BARREL	£ 5.00
REMAINDER	£ 4.00
ROBOTS	£ 3.00
ROUND THE HORN	£ 5.00
SAFARI	£ 4.00
SANTA PARAVIA	£ 4.00
SARGON* II	£ 15.00
SINK'UM	£ 3.00
SPACE BATTLES	£ 7.50
STARTREK III	£ 3.00
TIME BOMB	£ 7.50
TREASURE HUNT	£ 3.50
TRIK 90	£ 5.00
TAIPAN	£ 7.50
TYCOON	£ 4.00
X-WING FIGHTER	£ 4.00
WARFARE I	£ 4.00

ACCOUNTS RECEIVABLE	£ 12.50
APPOINTMENT LOG	£ 5.00
ASTRONOMY II	£ 6.50
BIORHYTHMS	£ 3.00
CALENDAR FUNCTIONS	£ 6.50
CALCULATOR	£ 3.00
CASH REGISTER	£ 5.00
COMPLEXMATHS	£ 6.50
CURVE FITTER	£ 6.50
ELECTRIC PENCIL*	£ 50.00
ELECTRONICS ASSISTANT	£ 5.00
ESP TESTER	£ 3.00
FILE HANDLING	£ 6.50
FINANCE (LOANS & INVEST)	£ 6.50
FINANCIAL PACK I	£ 6.50
FINANCIAL PACK II	£ 6.50
FOURIER TRANSFORMS	£ 7.50
GENERAL ACCOUNTING	£ 5.00
HAM RADIO	£ 5.50
HOME FINANCE	£ 10.00
INVENTORY MOO.	£ 10.00
INVENTORY FP.	£ 10.00
INVENTORY CONTROL	£ 5.00
KEYBOARD-80	£ 12.50
KVP EXTENDER	£ 25.00
LEVEL III BASIC	£ 6.50
LINEAR PROGRAMMING	£ 3.00
MATH DRILL	£ 5.00
MICROTEXT	£ 4.00
MORTGAGE CALCULATOR	£ 6.50
NUMERICAL INTEGRATION	£ 5.00
PERSONAL FINANCE	£ 10.00
PRE-FLIGHT	£ 5.00
RPN CALCULATOR	£ 7.50
RENUMBER*	£ 6.50
ROOT FINDER	£ 6.50
SCREEN PLOTTER	£ 3.00
SIMPLE SIMON	£ 5.00
STATISTICS I, II, III	£ 6.50
STAR FINOER	£ 7.50
SYSTEM COPY*	£ 37.50
LIBRARY 100	£ 20.00
75 BASIC PROGRAMMES	£ 6.00
MANUAL FOR ABOVE	

DISK

ACCOUNTS RECEIVABLE II	£ 40.00
ADVANCED PERSONAL FIN.	£ 12.50
AMATEUR RADIO SYSTEM	£ 12.50
ELECTRIC PENCIL	£ 75.00
GENERAL LEDGER II	£ 40.00
INVENTORY 2.2	£ 30.00
INVENTORY 2.3	£ 40.00
INVENTORY II	£ 50.00
LEVEL I IN LEV II RAM	£ 12.50
MAIL LIST II	£ 50.00
NEWDOS +	£ 47.50
TEXT-80	£ 30.00
ST 80-D	£ 40.00

TARANTO & ASSOCIATES CONVERSION OF OSBORNE & ASSOCIATES BUSINESS PROGRAMMES.	
ACCOUNTS PAYABLE	£ 90.00
ACCOUNTS RECEIVABLE	£ 90.00
GENERAL LEDGER	£ 90.00
PAYROLL	£ 90.00
MANUALS FOR ABOVE	£ 10.00
75 BASIC PROGRAMMES	£ 15.00
MANUAL FOR ABOVE	£ 6.00

*DENOTES MACHINE LANGUAGE SEND 50P FOR FURTHER DETAILS OF ABOVE PROGRAMMES. ADD 50P TO ORDERS UNDER £20.00 DEALER ENQUIRIES INVITED. ALL LISTED PROGRAMMES IN STOCK. FOLLOWING AVAILABLE TO ORDER.

FORTRAN	£100.00
CP/M	£ 75.00
MMSFORTH CASSETTE	£ 20.00
DISK	£ 25.00
PILOT	£ 12.50

MODEL II SOFTWARE NOW AVAILABLE



MICROCOMPUTER APPLICATIONS

11 Riverside Court, Caversham, Reading, RG4 8AL, England.

If you are thinking hard about which computer system to purchase, you need to talk to a company who can advise you wisely, supply a complete range of hardware and offer a full range of services.

Microsolve Computer Services have been involved with microcomputers since they first appeared in the U.K. All the experience we have gained at your disposal.

We offer consultancy advice on which system to choose, systems design, programming and installation of computer hardware. The equipment we supply ranges in price from £600 to £30,000 so that we can fit the needs of most customers.

Amongst our customers are public companies, accountants, solicitors, manufacturers, retailers, wholesalers, medical practitioners, educational establishments and small businessmen. We are especially experienced in dealing with the first time computer user.

Examples of the systems we supply are: —



This is one of the most versatile small microsystems available today. It is specifically designed to handle the day-to-day activities of education, scientific calculation, business, financial planning and even entertainment. The APPLE II Plus can be used on its own or as the basis of a most comprehensive computer system by adding such items as floppy disc drives and a printer. The APPLE II Plus is a complete system and has an entire range of accessories and peripherals:

- * Floppy disc drive
- * Real Time Clock
- * Light Pen
- * Pascal Language System
- * PRESTEL
- * Communications Interfaces
- * Music Synthesiser
- * Speech Input
- * Graphics Tablet
- * Colour Graphics

MICROSTAR

The MicroStar is a multi-user disc based information system designed for commercial applications where extreme simplicity of operation within a normal office environment is required. The powerful disc operating system supports both program development and system operation. Three terminal ports are provided allowing two users to operate the system simultaneously via VDU screens with a printer operating from the other port. Amongst the features available are:

- * Disc capacities of 1.2, 2.4, 4.8, or 20 million characters
- * Indexed, random and sequential file access
- * Generalised report generator
- * Standard packages including Sales, Purchase, Nominal Ledgers, Word Processing, Invoicing, Stock Control, Incomplete Records, Payroll, Solicitors, Accounting

THE ALPHA MICRO COMPUTER

The Alpha Micro gives a new meaning to the word "Cost Effective". It combines a powerful 16 Bit processor with a proven time sharing disc operating system to give you data handling and software sophistication parallel to that of high performance mini computers. It can be upgraded from a simple 64K single terminal floppy disc system up to a 24 terminal, multi-printer system with 2400 million characters of disc storage and 1.02 million characters of RAM. Other features include:

- * Fully Integrated Accounting System — Order Entry, Stock Control, Sales & Purchase Ledger, Nominal Ledger
- * Basic, Pascal, Assembler & Lisp languages supported
- * Indexed, random & sequential file access
- * Multiple level DMA and vectored interrupt system

*A full range of printers, VDU's, computer stationery and accessories stocked
Come and visit us on STAND 26 at the 1980 Microcomputer show or at our offices*

Microsolve

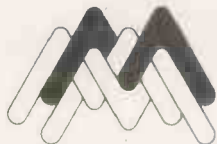

Microsolve Computer
Services Limited
Middlesex House
29-45 High Street, Edgware
Middlesex HA8 7XF
Telephone: 01-951 0218/9/0

Computer Sales and Services/
Consultancy/Systems Design/
Programming

M1 Junction 4, 20 minutes from Central London.

• Circle No. 153

Stop puzzling over the Micro Jigsaw and buy an operational system to fit your needs

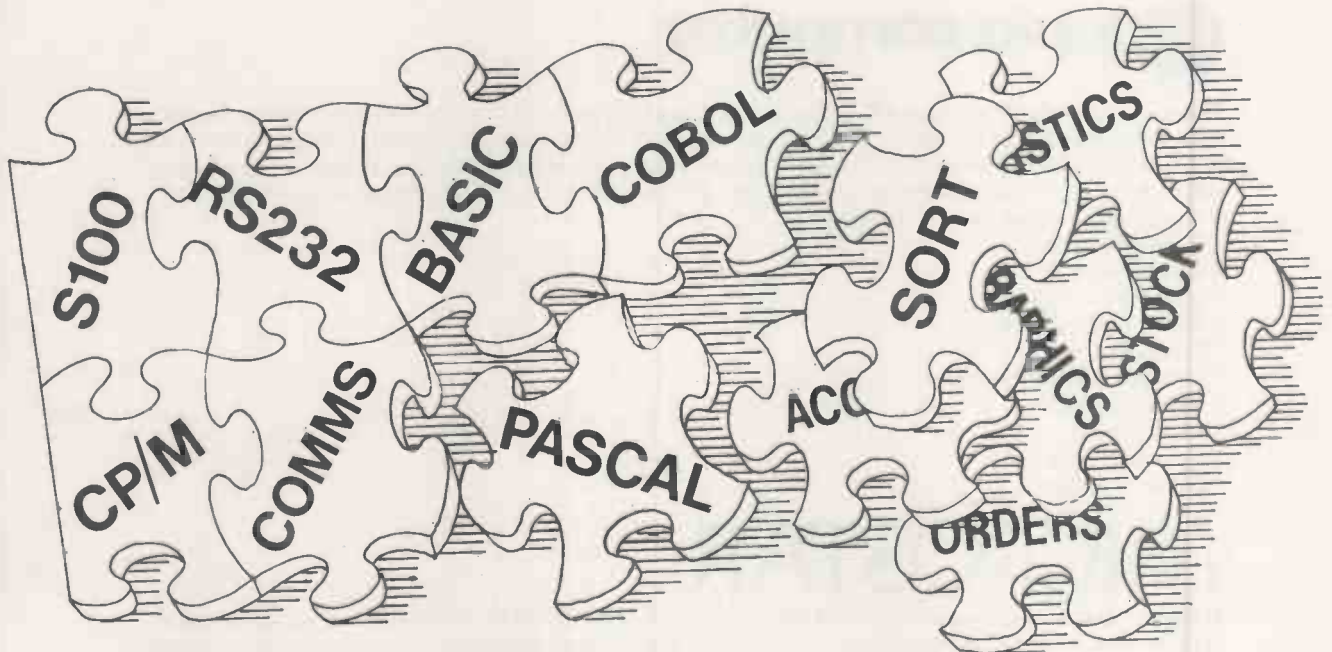

If only buying a microcomputer system was as simple as using one.

Just look at the advertisements in this magazine. When can you find time to digest them all?

There are millions of chips, thousands of boards and hundreds of peripherals, software systems and application packages. How do you pick the right ones to meet your requirements?

And put them together? And make them work? And add the specials you want?

At Digitus we have computer professionals working full-time putting systems together. Absorbing information. Testing equipment and software. Writing programs. Training users.

At one stop you can commission a complete system to fit your requirements.

Last year we supplied systems for: number processing, word processing, data processing,

graphics and machine control. Advised accountants, surveyors, archaeologists and engineers. Helped DP departments and small business men. Developed software for personnel, incomplete records, order processing, business games, linear programming, process control and terminal emulation. And were retained by other computer companies to advise on micros.

This year we can put even more experience to work so that you can benefit from micro technology ... in comfort.

Come and see us. Spend a few hours discussing your requirements. Attend a training course. Select a machine. Test drive some software.

Solve the micro puzzle. Buy an operational system that fits your needs.

Call for an appointment with one of our consultants.

Digitus

Digitus Limited 9 Macklin Street Covent Garden London WC2 Tel: 01-405 6761

• Circle No. 154

Software copyright and the law

THE VEXED question of software copyright is not often a matter for the English courts but the subject was aired when Science of Cambridge Ltd and Sinclair Research Ltd alleged that Compshop Ltd had copied certain features of the ZX-80 so flatteringly exactly on the MicroAce that it rendered itself liable to various sanctions that the law provides for those who tread on another's copyrights.

The case was of some interest because as the law stands many interpretations are possible — we will not know what the law is until a new Act is passed or a judge applies the old law to this very new problem.

Continuing problems

Science of Cambridge and Sinclair Research sought an injunction on the grounds that Compshop had infringed copyright in the special lettering of the ZX-80 keyboard and in the operating system and Basic contained in the ZX-80 ROM.

The case came before the Court on two days. On the first day, the plaintiffs sought an injunction to prevent Compshop and Product Launch, the promotions company, selling or advertising the MicroAce. An injunction is a kind of legal sticking plaster, applied by the Court to staunch the flow of blood until proper surgery can be done.

In the proceedings for an application for an injunction, too much weight cannot be placed on what the judge says, but in a case like this where the precedents are skimpy, any scrap of judicial wisdom is valuable.

Mr Justice Megarry said that he would not consider the question of copyright in the program in ROM because he "could not see it". He then granted Science of Cambridge an injunction over the keyboard copyright, quite reasonably it seems, since it appears it was a Sinclair keyboard protruding from a new box.

It is unfortunate that the ROM question was not argued and decided on the first day and was not considered on the second because the parties reached a settlement out of court.

To the microcomputing business it means continuing headaches. Until now, it has been assumed that computer software was subject to copyright — like the written word, drawn illustrations or music. In English law, as soon as you create any of those things, you have a copyright. In U.S. law, you have to add © and the date. Now it seems that this was an incorrect assumption.

Legal interpretation

The whole matter turns apparently on the meaning of the word 'writing' in the Copyright Act. The Act protects "every original literary work". "Literary work" includes any written table or compilation but is a computer program, when on disc, tape, in ROM or EPROM to be considered as 'writing'?

The interpretation section of the Act says: "Writing includes any form of notation, whether by hand or by printing, typewriting or similar process". That is both good and bad. 'Notation' looks good, since the representation of an ASCII 'A' by 0100001 in patches of differently-orientated magnetic domain is certainly notation and

has the readability and general acceptance one would expect of a 'notation'. "By hand or by printing" sounds bad. Those processes typically produce marks that can be seen and distinguished by the eye. One certainly cannot claim that for magnetic media or EPROMs. You can see some kind of writing in a ROM — if it has the lid off, but not if it's in a computer.

Presumably, that is why the Judge said he would not consider the software question. If Parliament wished to extend the protection of copyright to invisible writing, it could have done so. If people are silly enough to produce invisible writing, they cannot claim the protection of the Copyright Act, at least in its present form.

The Whitford Committee Report on Copyright and Designs Law (HMSO, Cmnd 6732) decided that a computer program when written on paper was probably protected, and: "It may be that protection also extends to programs expressed in the form of punched holes and even to recordings on magnetic tapes and discs. But there is no case law and the position is uncertain".

It is no help that the music on a tape or a gramophone record is protected, even though it is invisible, because that is covered explicitly by another section of the Act.

Machinery or writing?

It is vexing that one could argue that the pattern of bits on a disc is a kind of machinery — as mechanical as the cogs and levers in Babbage's vast bronze analytical engine in the Science Museum — and ought, therefore, to be patentable. The Patent Office, however, will almost certainly say that a pattern of bits on a disc, although novel, is a form of words and you cannot patent the contents of a piece of writing.

Software may be protected by the Act, as everyone thought it was. Unfortunately, there has never been a decision to settle the point, and in our system of law, there will not be a decision until someone takes a case to its conclusion.

So the matter rests. Until someone, at grave expense, carries a case through, or Parliament tackles this urgent problem, the whole question is open. It is a most unsatisfactory state of affairs. The rightful owner of software has to ask himself whether it is worth proceeding with a case that may make a lawyer's banquet and himself a fleshless skeleton. It will almost always be sensible to compromise.

When the number of computers in the world was numbered in thousands and the number on which any particular piece of software might run in tens or at the most hundreds, this question didn't really matter.

Contractual obligations

Software could be protected effectively by contractual obligations. There was not much purpose in stealing it since there was nowhere to hide it. Now that machines are numbered in the hundreds of thousands — and soon in the millions — there is every point.

It is a matter of the greatest urgency that Parliament takes some action. Until it does, we will have to tolerate the possibilities of plagiaristic actions. □

Our Feedback columns offer readers the opportunity of bringing their computing experience and problems to the attention of others, as well as to seek our advice or to make suggestions, which we are always happy to receive. Make sure you use Feedback—it is your chance to keep in touch.

Complete system

I HEARTILY concur with your editorial in the June, 1980 issue. I spent some time with traditional programming methods with a minicomputer and I am grateful I don't have to grind through that any more.

In those days, computing was not interactive. By contrast Basic is interactive, giving instant responses to commands and mistakes. You can interrupt a program, inspect or alter variables, edit instantly and the program cannot crash.

Compilers like Pascal are very slow to write, yielding little information about the progress of the program or its variables, needing a number of utilities to facilitate de-bugging. In short, Basic is not just a language but a complete programming system.

However, when you condense the issue from the prejudices, it comes down to economics. Basic is quick to write but slow to run, minimising the capital outlay in time/money to write the program. In a bigger system, doing the same tasks every day, and which must perform those tasks to maximum efficiency, the increased programming outlay pays for itself eventually.

For process control, I find the best system is to use assembly language, but with a good de-bugging aid. For automatic testing a good technique is to link Basic to machine language routines written in assembler — Hybrid programming.

**David Sand,
Orwell,
Hertfordshire.**

Language ideals

ONCE AGAIN, Peter Laurie has chosen to pontificate upon the ideal language for micros — editorial, *Practical Computing*, June, 1980. Starting from the premise that Pascal addresses problems irrelevant to programming on micros, he concludes that Basic is the only high-level language worth considering.

Surely anybody who has programmed seriously realises that the choice of an ideal language is not as simple as it may at first seem. There are almost as many ideal programming languages as there are languages.

If we must discuss Pascal, all that I would say is that it takes a fair time to learn to write clear Pascal programs, and during that period, Pascal doesn't suffer fools gladly. I also note that Laurie's

proposed enhancement to Basic would make it more like Pascal.

**Victor Rybacki,
London, SE23.**

Nightmarish result

I HAVE just managed, without cheating and listing the program, to achieve a score of 2,120 in the game nightmare 6, beating the possible total.

Is this a record?

**Darthy Bishop,
Oxford.**

Sporting advice

I HAVE now been a subscriber to *Practical Computing* for one year. It is a pleasure to read every month — the variety and scope of articles are very good.

In the article on Intelligent Gambling in the May, 1980, issue, under an alternative method of storing data, the author mentions the slow speed of his program. I believe it would be faster if one notes that at every return from GOSUB 20000 one has to go through the 11 A\$(. . .) = .

I would suggest the following modifications to an otherwise good idea:

```
400 A = 0
410 as before
480 deleted
500 to 520 (same as before)
522 A$(10) = "Tottenham 539" same for all
523 GOSUB 20000 13 blocks
524 A = A + 1 : IF A 10 GOTO 400
525 GOTO 523
```

Having no computer to test it, I can only presume the program works as written, but with reference to SUBR 20.00, I feel unhappy about GOSUB with no return, as is bound to happen when Z\$ = LEFT\$(C\$,L).

Perhaps one would accumulate too many GOSUBs eventually. I suggest GOTO 20000, in place of GOSUB 20000, and change 20010 on Z GOTO 480, 580, . . . 1580.

I am no gambler, but I am willing to bet many will adopt this idea of storing data.

**Donald Philippart,
Brussels,
Belgium.**

Basic single-step

ACCIDENTALLY, I have discovered that Nascom II has a facility for single-stepping in Basic.

When Basic is running, not during input, type "ESC" (= SHIFT/ENTER). That will halt execution. A second "ESC" would return to immediate mode as described in the manual.

Instead, type "CONTROL/ESC"

(CONTROL/SHIFT/ENTER) repeatedly. Each time, one Basic statement will be executed. So multiple lines will take multiple presses. Control/Shift can be held down and ENTER pressed to produce the single steps. To resume normal operation, "ENTER" on its own is typed.

During input, the above combination will produce a "{" character and will not single step.

I also have a hardware fault that only gives problems before the machine is warmed up. MID\$(A\$,I,1) returns the null string or has unpredictable results for the first 15 minutes of use. It crashes a program used to write to the top line of the string.

The program is:

```
10 A$ = "TITLE":REM PUT YOUR TITLE
HERE.
20 FOR I = 1 TO LEN(A$)
30 J = 3017 + I : REM DEC ADDRESS OF
TOP LINE
40 POKE J, ASC(MID$(A$,I,1))
50 NEXT
```

The error is caused by trying to find ASC(""). The routine has the advantage of not using the other lines of the display, unlike the Nascom version. Poking the VDU RAM doesn't produce any ill effects on my display.

**David Green,
Nairobi,
Kenya.**

Applications request

I AM attempting to compile a short book on microcomputer applications in the home.

I would, in consequence, very much like to hear from any readers about any applications they have devised for their equipment.

**Ian Fraser,
Warrington,
Cheshire.**

UK101 defended

I FEEL THAT Martin Collins levelled unjust criticism at the excellent UK101 in his review in *Practical Computing*, May. He stated that while typing lower-case, shift lock has to be pressed to obtain the special characters like "&," etc. That is not the case.

To obtain special characters, he needs merely to press the right-hand shift key, which acts as a double shift. Also, to obtain upper-case, rub out and return, he should use the left-hand shift key, which is a single-shift key. Of course, when in

(continued on page 44)

ATHENA

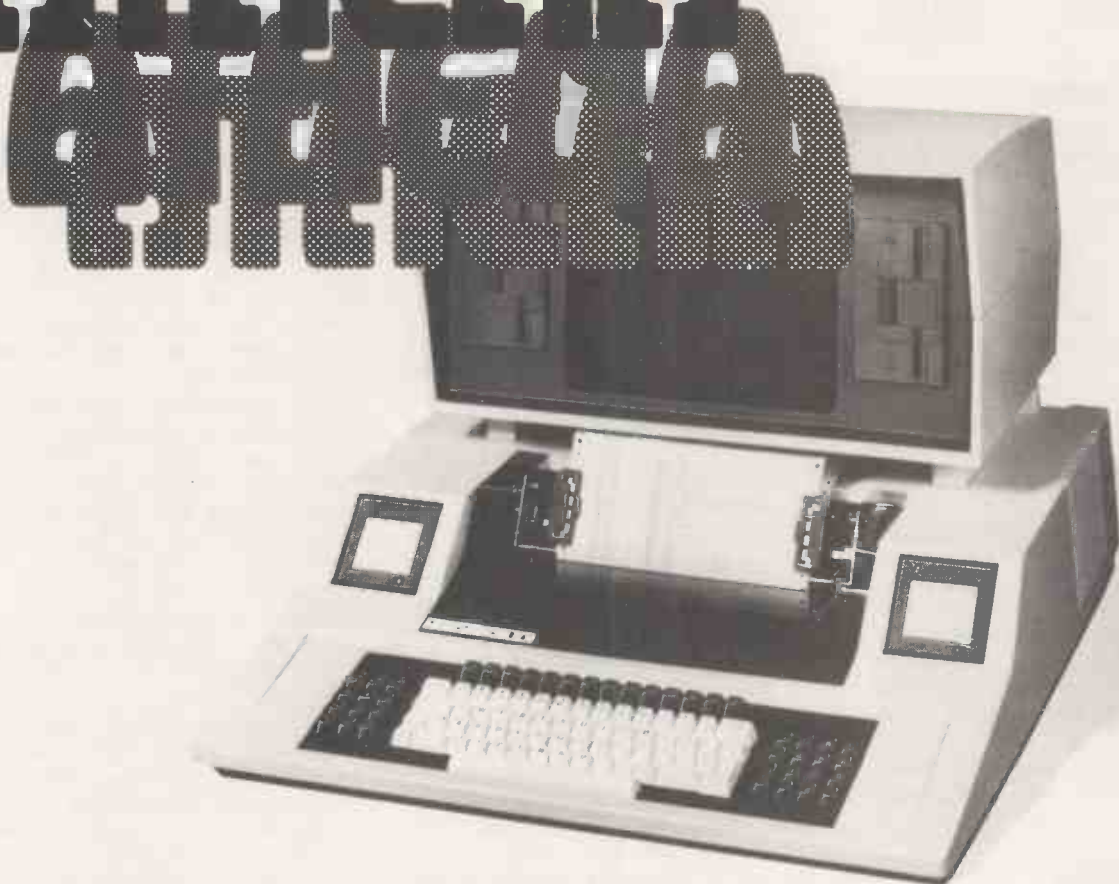

The desktop computer that thinks it's a mainframe

Compare these features with micros, minis or even mainframe computers. Then have a guess at the price of putting an Athena on your desk. We can guarantee that, even if you are already very aware of all the latest advances in multi-micro desk top computers, the answer will surprise you.

The Athena can be tailored for personal, educational, business and industrial users. It can stand alone or be connected to larger systems in a distributed processing environment. It is flexible and easily up-graded to meet changes in application requirements.

The basic system starts at £3,380. A typical configuration with 64K, integral dual floppy discs, 150 cps printer and software costs £7,954.

BUTEL·COMCO
Technology for business

- Multi-processing with intelligent buffered peripheral controllers
- 64Kb RAM PROM Memory
- Integral 150 cps matrix printer
- Additional external printers and terminals
- Storage modules from 12 to 300 Megabytes
- Up to 1200 Mb of disc storage
- Integral mini-floppy discs and cassettes
- Remote communications – asynchronous or synchronous
- Powerful multi-tasking operating system (AMOS)
- COBOL, Fortran, BASIC, Pascal and APL compilers
- Proven accounting package in COBOL – Sales, purchase and general ledgers, order entry, invoicing and payroll
- Text editing package

Butel-Comco Limited
50 Oxford Street,
Southampton, Hants. SO1 1DL
Telephone: Southampton (0703) 39890. Telex: 47523

● Circle No. 155

(continued from page 42)

upper-case mode, both shift keys act as single-shift keys.

Readers might also be interested to know that a new monitor for the UK101 is now available — it allows cursor-control and editing facilities, and can save data on tape, improving an already excellent machine.

Alan Birse,
Clydebank.

Explanatory notes

I LIKE the magazine enough to be on my second annual subscription but practically every program is to some extent machine-dependent, different screen sizes require different PRINT formats, Basics differ and POKE locations particularly will have totally different addresses.

Could we have some notes in each article explaining such points? Then readers could translate the many excellent programs you publish for their own machines much more easily. Perhaps I feel this more than most as I have an Ohio Challenger and so have to translate almost everything.

As an alternative to notes in every article, could you publish a series of pull-out supplements giving details of different machines? By keeping them on file, readers could then look up the meanings of machine-dependent statements, screen addresses and lay-outs, etc. You could even couple these with your product reports.

Roger Beaumont,
Keighley,
Yorkshire.

QWERTY revisited

WITH REGARD to the QWERTY explanation by R Fawdry — Feedback, May, 1980. The reason for the lay-out of the typewriter keyboard, which goes back to the 1860s, is that once the operator had achieved typing at speed, the type bars became entangled with one another. To avoid that, a deliberate flaw was made in the lay-out of the keyboard, thus the letters used most often were re-sited as far as possible away from each other.

That had the effect of reducing the typists speed and the chance of type bars becoming entangled. The keyboard was named after the first six letters on the top line, QWERTY. The person to whom the credit went for QWERTY keyboard and the typewriter itself was Christopher Scholes, a newspaper editor in Milwaukee.

Keith Swainson,
Nottingham.

• Scholes' brother-in-law, a school maths teacher, designed the QWERTY keyboard to increase the speed of his typewriter. It was adopted as a standard after a much-publicised speed typing competition held just before the turn of the century. Tony Swainsberg, from Extel, has pointed out that 52 percent of the English language can be typed on the top row of letters. A

simplified keyboard, it is claimed, could mean that a full-time typist, working an eight-hour shift would move her fingers only one mile in the day rather than 20.

Quirk of QWERTY?

CONCERNING recent comments on the QWERTY keyboard, is it any more than a coincidence that the longest word I can make from the letters on the top row of my typewriter is TYPEWRITER?

Matthew Bradwell,
Harby,
Leicestershire.

MisAdventure

ALTHOUGH I have a certain amount of sympathy with Lawrence Davis and his colleagues, Feedback, May, 1980, I was dismayed to see his letter published.

The whole essence of the game of Adventure is that one is venturing into the unknown. Even the questions he asked could open new areas of the cave to other people, while, if the answers were published, a great deal of enjoyment for a large number of people would be destroyed.

Graeme Thomas,
Weymouth,
Dorset.

PDP-8 appeal

352 SQUADRON Air Training Corps recently ACQUIRED an ancient, but working, PDP-8 to add to a Pet 16K micro already in use teaching cadets. DEC has been remarkably helpful in providing help and advice, but, of course, we eventually encounter the problem of cost.

Should any readers have manuals referring to any aspect of PDP-8, we would be delighted to hear from them. We are also interested in hearing of any surplus computer equipment in need of a good home.

We would, of course, be prepared to pay carriage charges or arrange collection of any documents lent for copying and for any equipment which your wife/managing director has been nagging you to get rid of for the last six months.

Finally, should anyone in the Burnley area be interested in seeing, helping with operating/pinching time on the above system, you are most welcome to ring me on Burnley (0282) 20009.

Graham Bird,
Burnley,
Lancashire.

Quick printer

IN TANDY FORUM of the May, 1980 issue, I note that Chess Ferrier says the quick printer is for the hobbyists. I do not agree. With a little know-how, I have managed to turn mine into a small word processor which allows me to write small notes to most of my business contacts, including the tax man. They all seem to accept the format I use and a lot of them are very

keen to try it. The main point to my letter concerns the problems of cost saving.

I have at times fumed when I have read articles in computer journals about how much a small business has to spend to obtain micros. As a small business micro user, I can tell you that the money is well spent as far as doing the weekly books and the quarterly VAT return, but the micro in most business situations does not bring in any money, so the outlay must be reasonable. That is why I would love a large printer, but a quick printer will do for now.

David Lloyd-Jones,
Netherfield,
Nottinghamshire.

Delivery problems

I AM writing to you in the hope that the public airing of the subject of delivery might lead some of the hobbyist computer industry down a more efficient path to successful business.

While I am prepared to give the benefit of the doubt to the majority of firms who no doubt always deliver the correct goods on time, the consistent troubles we have had in ordering and taking delivery of software, literature and hardware from some firms put coincidence well beyond the realms of probability.

The only conclusions that I can draw are that firms often advertise goods which are either not in stock or not in production.

Because of the items I require for my work, I can raise an official order for goods and our ordering system is such that payment is made within 30 days of receiving the goods; no goods, no money. What of people who have paid *pro forma* invoices and can be waiting for goods for three months to a year after they have paid? How many telephone calls can they afford to make chasing up orders? With what confidence will they re-order goods from the same firm?

What is to be done? We have learned our lesson, and in future will stick to those firms who have provided a good reliable service. The extra cost is well worthwhile. As for software, it is quicker to order it directly from the U.S. if no U.K. alternative exists.

It has constantly amazed me that so many firms seem not to care whether they lose business or not. The customers ultimate sanction is presumably the cancellation of his order. I would advise caution in using that as a deterrent as it does not appear to work.

Much to my surprise many firms show no emotion at all if orders are cancelled and the only conclusion is that they must be happy to implement a take-it-or-leave-it policy and not worry about their customer relations.

While some companies obviously put to good use the systems they sell, many others still process all their work manually.

C Taunton,
Cardiff Royal Infirmary. □

“If you want what’s best for your PET, choose Commodore software.”

Kit Spencer
General Manager
of Commodore Systems
360 Euston Road
London NW1 3BL



The Commodore PET is Britain’s best selling micro-computer, with over 10,000 already installed in a wide range of fields, including Education, Business, Science and Industry.

This has led to a tremendous demand for high quality software.

And Commodore has met this demand by producing a first class range of programs, now available from the nationwide network of Commodore Dealers.

Commodore’s support also includes training courses, a Users’ Newsletter and Official Approval for compatible products of other manufacturers who reach agreed standards.

COMMODORE PETPACS

Over 50 Petpacs of programs are available (mainly on cassette) from Commodore Dealers. These cover such popular titles as Strathclyde Tutorial, Statistics pack 1, Assembler Development System, Stock Market Trends and the Treasure Trove Collection of game packs including the award winning Star Trek, which is packaged with Petopoly. Prices are from £5 to £50.

TRAINING COURSES AND SEMINARS

PET systems are simple to use and any normal advice or assistance

NEW BUSINESS SOFTWARE PROGRAMS ON DISK

Commodore’s Floppy Disk Unit and high-speed Printer, combine with the PET to form a complete system (ideal for running a business) for under £2,500.

Commodore also produce a growing range of business software on disk available from Official Business Software Dealers.

Business Information System – COMBIS £150 + VAT.

Combis facilitates the storage and instant retrieval of all kinds of company records, from personnel files to mailing lists and printed address labels.

Stock Control – COMSTOCK £150 + VAT

Comstock provides an accurate, up-to-the-second and comprehensive stock position for as many as 1,300 products.

Word Processor – COMWORD £75 + VAT

Comword turns the system into an excellent word processor.

Payroll – COMPAY £150 + VAT

Compay is a new, comprehensive payroll package.



you may need can be obtained from Commodore Dealers.

On the other hand, for rapid training on a basic or advanced level, you will certainly be interested in Commodore’s intensive 2 and 3 day residential courses. We also run one day general appreciation seminars.

PET USERS’ NEWSLETTER

This is Commodore’s official method of sharing new information and ideas between the many thousands of PET users. The newsletter is published regularly and for an annual subscription of £10 you can start receiving copies now.



Look out for this sign. It tells you that compatible products of other manufacturers have met with our standards of approval.



To: Commodore Information Centre, 360 Euston Road, London NW1 3BL 01-388 5702

I am a PET owner Please put me in touch with my nearest dealer

Please send me details of: Commodore PET Software

Training Courses & Seminars I would like to receive the Users’ Newsletter and enclose £10 annual subscription

Name _____ PC7

Address _____

Tel. No. _____

commodore
We made small computers big business.

Fujitsu hard discs move into Europe

ANOTHER Japanese company looks set to make its name heard in the U.K. — this time through the sale of Winchester technology hard discs. The massive Fujitsu corporation has recently signed a deal with the California-based Systems Industries (SI) giving them the right to sell the discs throughout the U.S. and Europe. This will be the European debut for Fujitsu disc drives and marks the entry of SI into the Winchester technology market.

The agreement covers the

Space Invader challenge

IN AN attempt to appeal to our baser instincts, Newbear Computing Store is organising a Space Invader competition for the MZ-80K. A prize of £50 will go to the highest authenticated score between now and Christmas. Newbear has also produced its manual for Sharp Basic.

Deep Thought developed

RESEARCH MACHINES is developing a 32-bit machine provisionally masquerading under the title Deep Thought. It is said to be a bit slice device using the AMD 2900 family.

It will have a 24-bit address line which means that it will address a touch less than a million memory locations.

M2282/3/4 series of discs which will be sold in Europe as the 972/3/4. The drives offer access times of 6 milliseconds, track to track and 27 milliseconds average and contain storage capacities of 66, 132, or 165 megabytes of unformatted data. SI is claiming that a typical cost for the OEM user will be around \$5,500 for 165 MB.

Managing director of SI(Europe), Pip Smith, says: "We are planning for European shipments of the Fujitsu

drives of around 1,000 units during the first year of the agreement". He claims that Fujitsu is now the second largest manufacturer of Winchester technology drives. He adds: "Cutting data costs is critical. Typical costs of backing up a 300MB disc are in excess of £600. We believe the Fujitsu drives will provide comparative savings for disc users".

The U.K. subsidiary of SI is based in Woking, Surrey. Tel: Woking (04862) 5077.

ZX-80 and MicroAce settle their differences

IN A CASE not without precedents in the world of micro-computing, Compshop recently proposed to launch a microcomputer bearing a striking resemblance to the Sinclair ZX-80, even to the extent that the keyboard appeared to be identical. The kit was to be advertised at a retail price of £50 and would have been sold under the name of MicroAce. Kerr Borland's company, Product Launch, was to have handled the promotion.

On May 23, Science of Cambridge secured 'successfully an *ex parte* injunction against Compshop and Product Launch which prevented them from advertising or selling the product on the grounds that

the keyboard breached the Science of Cambridge copyright. The case returned to court on June 3 but was settled out of court.

Under the terms of the agreement between Compshop and Science of Cambridge, Compshop will have the exclusive rights to sell the ZX-80 kit in the U.S. using the name of MicroAce while Science of Cambridge will continue to sell the complete system. Comp-

shop has agreed to pay Science of Cambridge royalties.

About 9,000 orders have been placed for the ZX-80 and there is a backlog in meeting the demand. Sinclair produced about 2,000 systems in June, hopes to produce 4,000 in July and nearly 10,000 a month by the end of the year. Compshop hopes to sell up to 50,000 kits in the U.S. while Sinclair aims to sell over 100,000 complete systems.

New industrial micro from Data Applications

A NEW industrial microcomputer system, first launched by Data Applications at the Com-

pec Europe exhibition in Brussels in May, is housed in a standard 19-in. Eurobox with two mini-floppy disc drives, and offers a disc controller card with PROM resident DOS, up to 60Kbytes of RAM and a 2708 EPROM programmer card.

It includes interfaces for a standard terminal, parallel printer and paper-tape reader/punch. The system is based on the DCE-BUS.

System software includes a text editor, macro assembler and a utility package providing debug function including program trace with automatic display of all CPU registers after each instruction execution. There is an automatic battery back-up.

The Data Applications industrial microcomputer has a PROM-resident DOS, up to 60Kbytes of RAM and a 2708 EPROM programmer card. The system is based on the DCE-BUS.

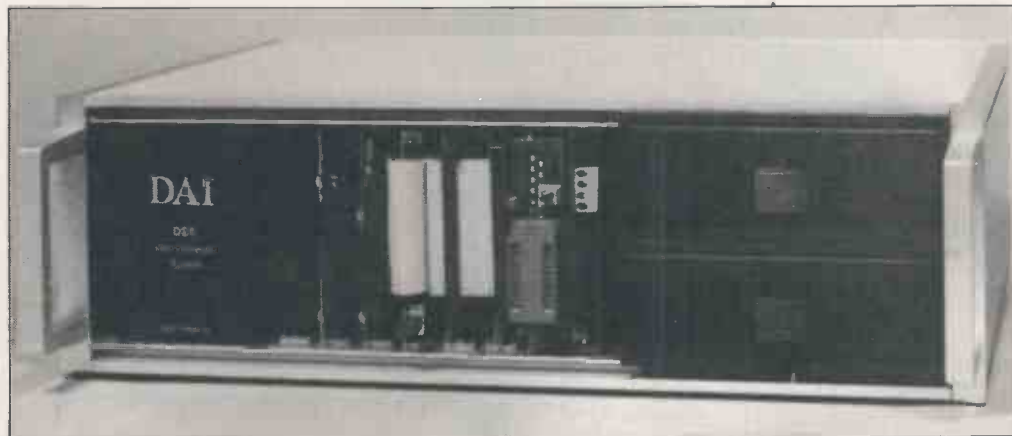



NewBrain is latest hand-held machine to enter the field

ANOTHER entry into the hand-held computer market has been produced by Newbury Laboratories, the Odiham-based offshoot of the National Enterprise Board. Designated the NewBrain, the new computer will be released on to the

market in September at starting price of £155 for a model (M) without an integral display, on battery back-up.

A more expensive version, the MBS, which includes an integral display and a re-chargeable battery back-up, costs

£245. The model can be connected to a TV set and a wide range of other interfaces are available.

The system's software includes a full screen editor, a Basic compiler, operating system and a mathematical package which is accurate to 10 significant figures.

Modules under development include assembler, Cobol and Pascal and utility packages written in Basic and assembly code. Newbury Labs (025) 671 2910.

First true pocket computer

THE FIRST truly pocket computer which can be programmed in Basic has been launched by Sharp as the PC-1211. The earlier offering from Sharp, the MZ-80K personal computer, is now being marketed more aggressively as software and peripherals start coming on-line.

Peripherals now include the Sharp 5¼in. floppy disc units and a matrix printer.

System software includes an editor-assembler, a re-locatable loader and a symbolic debugger. H B Computers, of Kettering, has been appointed

as the Sharp software agent and it will be publishing a catalogue of software shortly. 

Sharp 5¼in. floppy disc drives.



380-Zs offered as prizes in DoI competition

THE DEPARTMENT of Industry, with the support of the Department of Education and Science, has announced a competition for schools with 100 Research Machines 380-Z microcomputers as prizes.

All secondary school headmasters have been contacted by

the Department with details of the competition which closes at the end of July. Pupils have been asked to submit a project in whatever form they choose — essay, film, slides and so on — to describe how their school would best use a microcomputer. When the winners have

been finally chosen, the Department of Industry will train the teachers of each successful school in the art of microcomputing. Entries should be sent to the Department of Industry, Room 326, Dean Bradley House, 52 Horseferry Road, London SW1P 2AG.

Dazzling the micromice

SOME of the entrants to the *Practical Computing* Micro-mouse competition are worried that, if the final is shown on BBC television, lights could upset their mice.

J E Noakes of BBC Television Outside Broadcasts, says: "If a television unit is used at the competition, the lighting will be tungsten and may be up to 150 candles, but most likely will be less at about 120fc.

"The colour temperature will be 3,200°K which should give you an improvement on the values in the table as a result of the shift towards blue. A film unit, however, may use either tungsten or HMI lamps and the lighting level may be up to 400fc".

The figures in the table will give you an idea of how the power is distributed between the wave lengths at a temperature of 3,000°K. The power at 560nm is taken as being 100.

Wave Length	Power	Wave Length	Power
300	1.36	800	219.63
400	17.52	900	237.74
500	63.09	1000	239.94
600	125.33	1100	231.41
700	181.68	1200	216.58

The Paris office of Euro-micro 80 has circulated a questionnaire to all contestants in the 1980 competition. If you have been omitted from their list, please write to John Billingsley, Department of Engineering, Portsmouth Polytechnic, Anglesey Rd., Portsmouth.

Nascom calls in receiver

THE problems of surviving in the rapidly-growing micro-computer business have been well highlighted by *Practical Computing* in the past and it is a well-known danger that the company you buy from today may have gone out of business tomorrow leaving you stranded for parts and technical sup-

port. It is, however, particularly sad to have to report that one of our best known and successful manufacturers, Nascom, has called in a receiver. Several weeks ago John Marshal of Nascom announced that he was looking for a buyer to help support his investment plans after his backers, Grovewood Securities declined to inject any more capital into the company.

In June last year, Grovewood invested £500,000 in Nascom, shortly after the launch of the Nascom 2 which cost more than £250,000 to develop. Problems in securing supplies of EPROMs for the first Nascom 2 delayed the return on the investment.

NCC Anaheim report

THE 1980 National Computing Conference, held in Anaheim, California in May, was yet again a great success, attracting an estimated 80,000 visitors each day.

The most crowded stand at the show was certainly the Apple Computer booth, where, if you were good at pushing through crowds, you could see the new Apple III, the cause of a good deal of speculation for some time. The company has stuck with the versatile 6502 micro, as with the Apple II, but custom-designed LSI chips surround the processor, enhancing the instruction set, and enabling it to address up to 128K of RAM.

New version DOS

A built-in mini-floppy drive runs under a new version of DOS to give up to 126,976 bytes of storage.

The Apple III is obviously designed for the small business user. It is to be sold in packages including the machine, monitor, the new Apple Silentype thermal printer, and software including a Sophisticated Operating System (SOS), VisiCalc III, Mail List Manager, Apple Business Basic, a WP package, and other items.

The unit includes a contoured QWERTY keyboard with numeric pad, specialised cursor control keys, and two keys for normal and reverse video. Interfaces are built-in and include RS232 and Silentype ports. The display output to the monitor includes upper- and lower-case.

Apple II emulator

A useful utility capability on the Apple III is an Apple II emulator which enables the III to behave just like its predecessor, so that your existing software is not made redundant.

On one machine, a demonstration program divided the screen into coloured rectangles, across which horses galloped and birds flew. These remarkable demonstrations utilised the text mode of the Apple III — certainly an impressive machine. It should be available in the U.K. by the end of September.

Other products from Apple, new at the show, include Apple

Pilot and Fortran. The Pilot system requires an Apple II or II Plus with 48K and one or two disc drives depending on the application. Packages are offered aimed at the CAI market, and allow graphics and music generation apart from the normal interactive capabilities of the language.

The Fortran package offers a version of the language which is ANSI Standard Subset Fortran 77, which provides significant additions to the



The new Apple III.

previous 66 standard — known as Fortran IV. This version includes structured programming possibilities through expanded IF statements.

Fortran operates in the Apple Pascal language system, enabling Fortran, Pascal and assembler routines to be created into a single program. Additionally, Apple Fortran handles high-resolution graphics, sound, and control paddles. Fortran requires the language system plus 48K and at least one disc drive.

Thanks to Microsoft, you can now run CP/M on your Apple. The Z-80 Softcard from Microsoft enables you to run CP/M on the Apple and includes a 4MHz Z-80 processor, running at about 2.04MHz. Z-80 addresses are offset by \$1000, so that the Z-80 sees CP/M programs at their correct locations without affecting screen memory. Entering card is simply a matter of booting the CP/M diskette. CP/M occupies 7K. Also supported by the card and supplied on another disc is the Microsoft ANSI standard Basic 5.0.

The APF Electronics new IM-1 Imagination Machine is low-cost, self-contained and, perhaps surprisingly, based on the 6800 micro. Apart from the Technalogs system, no other small machine is based on this processor.

The Imagination Machine is built into a sturdy plastic case with full QWERTY keyboard, built-in cassette machine which uses digital recording at 1200 Baud, sound synthesiser and speaker, and two hand-

controllers with numeric keypads and joysticks. Built-in is a Basic interpreter, plus 9K RAM and 14K ROM, both of which may be expanded.

The screen format is 32 characters by 16 lines, with alpha- numerics in three colour modes. Base-resolution graphics offers 64 x 32 with up to eight colours intermixed with alpha- numerics, while two high-resolution modes offer 128 x 192 in eight colours, or monochrome only with 256 x 192 resolution.

Basic keywords

Major Basic keywords may be entered with single key-strokes, and the unit includes an RF modulator. Software is available on cassette or in ROM cartridges. The IM-1 may be expanded with the BB-1, building block system, which offers four ports for peripheral-drive cartridges, including one such pack for a standard RS232 interface, selectable in eight baud rates from 110 to 9600 baud.

An 8K-RAM cartridge plugs directly into the machine for memory expansion, and a disc

interface cartridge drives up to two standard 5¼in. drives. A 300-baud originate/answer, half- or full-duplex modem is also available. The floppy drives are standard SA400-compatible offering 72K per single-sided diskette, with standard IBM formatting.

Disc commands are built into the Basic interpreter cartridge. A 40-column serial thermal printer is also available. The IM-1 apparently is to be distributed in the U.K.

Impressive machines

Looking moderately like a new-type Pet but with a bigger — 80-column — screen format, the new 8000 series from Commodore was strongly in evidence on the CBM stand. The Pet name seems to have been dropped on the new equipment. Unfortunately, however, those impressive machines, complete with green-phosphor screens, were unsupported by documentation. An extensive range of 8000-series software, which includes WP and business packages, is available.

The 8000 series already includes a neat dual-disc package and printer. The DOS appears to have been re-written extensively with a number of very useful utilities, including a routine to copy or restore a corrupted file.

Triple-processor

On the Ohio Scientific stand, the triple-processor — Z-80, 6800, 6502 — C3 systems, ran various business packages and CP/M. Also on display were the Challenger C1 — Superboard II in a case — and the new C4. This machine includes full-colour displays of 16 hues, background and foreground including alpha- numerics and graphics characters, with upper- and lower-case display of 64 characters by 32 lines.

The C4 is a development of the earlier C2 and, in keeping with Ohio Scientific policy, is both hardware — and software — compatible. The machine includes two RS232 interfaces, sound and C/A outputs and something like 50 add-on boards are available to handle more or less anything from discs — 5¼in., 8in. or hard discs — to D/A, A/D and power control systems from burglar alarms to room lights. □

Now you can control your business for less than £2,500.

This could be your best investment opportunity yet. A complete computerised business system, including a Floppy Disk Unit, high-speed Printer and *Britain's best selling microcomputer* – the Commodore PET. All for under £2,500.

First Class Programs

A comprehensive range of first class programs is offered by *Commodore 'Business Software' Dealers*. These are available on disk from £50-£500. And they cover such applications as *Business Information, Stock Control, Word Processing, Payroll, Accounting and Mailing Systems*.

Service and Support

With over 10,000 PET computers installed in the UK, dealer support is growing fast. A nationwide network of 90 official

Commodore 'Business Software' Dealers ensures that service and technical facilities are close to every PET user. Our dealers can even offer you a 24 hour on-site maintenance agreement.

Training and Instruction

The PET Business System is self-contained and simple to use. Should you require personalised programs or extensive installation training this can be arranged with your *Commodore 'Business Software' Dealer* who can also give details of official *Commodore Training Courses*. These include intensive 2 & 3 day workshops to train you to write your own programs.

For full details about the Commodore PET Business System, Training Courses, Programs, and *'Business Software' Dealers*, simply fill in the coupon and post today.



To: Commodore Information Centre,
360 Euston Road, London NW1 3BE.

Please send me details of the PET Computer Business Systems.

Name _____

Position _____

Company _____

Address _____

Tel. No. _____

If you have a particular application in mind please specify:

P.C.B. 7

commodore
We made small computers big business.

• Circle No. 157

PAYROLL-200

PRESS 'P' FOR PAYROLL RUN
 PRESS 'M' FOR MONTHLY SUMMARY
 PRESS 'I' TO INPUT A NEW EMPLOYEE
 PRESS 'E' TO EDIT EMPLOYEE RECORD
 PRESS 'R' TO REDO THIS WEEKS PAY
 PRESS 'A' TO ALTER A SINGLE WAGE
 PRESS 'B' TO RETURN TO BASIC
 PRESS 'D' TO COPY THE DATA DISK

With the present glut of payroll systems, the search for the right package may prove a harrowing experience for the prospective buyer. To help him through that ordeal, Mike McDonald looks at Payroll-200, a package from Petsoft, which runs on the Commodore 3032.

Payroll-200 offers good value for money

PETSOFT is a subsidiary arm of the Micro-ACT venture established by ACT in Birmingham. Julian Allason founded Petsoft and still directs its efforts to make it the leading supplier of software for the Commodore range of microcomputers. In addition to the weekly payroll package, Petsoft also offers purchase and sales ledger, stock control, and sales invoicing for the 3032.

Payroll-200 is a weekly payroll system for Commodore systems comprising a 32K Pet, printer, and dual mini-floppy disc drive of either Commodore or CompuLink origin. The maximum number of employees using the Commodore 2040 or 3040 disc drives is 200 and the system is based on fixed-length records. The facilities offered by Payroll-200 are:

- A standard week facility to reduce data entry for weekly runs to only that information which has varied.
- Tax codes catered for are L,H,P,V,T, BR,NT, and prefix D and F codes on both cumulative and week one systems.
- Standard, reduced-rate, and zero-rate National Insurance contributions for non-contracted-out schemes.
- Global alteration of tax code values to allow for changes in legislation.
- Three wage rates — normal, time-and-a-half, and double-time for each employee with holiday, sick-leave, bonus, and adjustments routines.

Payroll-200 costs £50 and is supplied as an A5 wallet containing a single floppy

disc which carries programs and a small neat operator's manual. The package comprises a suite of programs of which only two are accessible by the operator. They are a start-up routine for pre-formatting data discs to be used with the system and the payroll program which menu-drives the balance of the functions.

The master disc is always left mounted in the left-hand drive 1 and data disc in

by Mike McDonald

drive 0 while running. The start-up program is a simple disc-formatting facility which is run initially against a blank diskette.

The routine initialises the disc into 400 records and issues a series of status messages informing the operator of its activities — a measure to prevent error. Once performed, the start-up program is unlikely to be used again and the balance of use is via the payroll program.

Having prepared a data disc, the main program is loaded and run. The first activity encountered is a password routine which requires the currently-logged password to be entered. If the entry is incorrect, the Pet is re-initialised and the program lost. On correct password entry, the master menu is loaded and displayed and normal running can begin.

While the menu is displayed, a countdown begins which, if left, on reaching zero will time-out and program execution ceases. The user must then re-run the

program and enter the password again to regain access.

It is an exceedingly useful routine which will stop any unauthorised users from interrogating the payroll if the machine is left unattended for any length of time. The standard of security in the system is very good. Programs are loaded directly to memory and are, therefore, not listable by the ordinary user.

We were able to break the system in the end but not without a good deal of peeking and poking on at a high level. It is extremely unlikely that any user will ever encounter any source code for this system, except by a rare accident. The suite of programs are also non-interruptible except by error-exit and user-exit routines.

The menu displays the more-commonly-accessed options with occasional routines, i.e., year end, budget changes shown in the operator's manual. Functions are:

Command Letter	Function
P	Weekly payslip production & reports
M	Monthly summary
I	Input new employees
E	Edit existing employee records
R	Re-do current payroll, re-run option
A	Alter a single wageslip
B	Return to Basic, program end
D	Copy data disc
Shift A	Annual re-start
Shift B	Budget amendments
Shift C	Change password
Shift L	List all details of employees

Shift items are not displayed as options on menu.

The two main functions in the payroll are the entry and editing of employee

details and the production of weekly payroll with modification to individual details where deviation from a standard week has occurred. The first exercise was to enter the employee details into the system.

On entering the input program, a data entry form is displayed on the screen depicting an employee record card. All data is held in the one screen format and good use has been made of the Pet graphics to produce a highly-legible 'soft' document.

The user is prompted through each field by a flashing cursor and various options validated, range checked, and queried if excessive. The fields and each of their options are:

- a. Employee name — 20 characters' maximum. Letters spaces hyphens and dots are permitted.
- b. Hourly rate — hourly pay in pounds. Maximum entry 9.99.
- c. Normal bonus — lump-sum payment, maximum 99.99.
- d. Normal hours — standard week in hours, maximum 99.99 — confirmation request if in excess of 50.
- e. Annual holiday — total hours of annual holiday entitlement — maximum 999.99, confirmation request if in excess of 160 hours. That figure is reduced as holiday money is paid by the system.
- f. Tax code — only valid codes are accepted, i.e., L,H,P,V and T suffix/ prefix D & F and NT and BR plus up to 4 digits numeric. Invalid codes rejected.
- g. Tax week 1? — yes or no reply to determine calculation of tax on a week-one basis or cumulatively.
- h. NI rate — choice of higher, lower, or zero rate (a,b,c) deductions for each employee.
- i. Pay method — C,T or Q for cash, credit transfer or cheque payment.

Used by system for cash analysis and summary listings by payment type. Cheque and Giro print routines are not included.

- j. NI number — entry of AA999999A is permitted and re-formatted to NI standard form, i.e., AA 99 99 99 A.
- k. Gross pay TD — cumulative field for entry of new employee's previous earnings in current tax year. Maximum 99999.99. Can be adjusted if necessary.
- l. Tax paid TD — as for k. for cumulative tax year.

Once each field is either filled or return entered, the cursor moves on to the next automatically. Each field on the form has a field-identifier letter and each field may be accessed for editing or re-entry simply by entering the identifying letter at an appropriate point.

Incorrectly-typed fields may be deleted at the time of entry, and re-entered. Once a record is complete the user may input more employees, edit existing employee records, exit from the program or return to the menu. At the beginning of each new entry, the system requests a first pay-week number to be entered.

That number will determine when the system will begin to pay the joiner. If the number is less than the current week, backpayment will not occur. The program will allocate a payroll number to each new entry automatically on a first-free-number basis.

Entry to the edit routine requires the employee's number to be entered. Also at the edit stage, the user is given the choice of deleting employees from the system. Removal from the payroll does not occur until the next month-end is run. That keeps the summary totals correct, i.e., if the employee is paid for the first two

weeks of the month. Payments are stopped from the time of deletion until the month end-run.

We were unable to establish if the space occupied by the deleted employee's record could be re-used as it proved difficult to complete a successful month end-run when records had been flagged for clearance. The program failed with a file-not-open error. It may have been due to a slight corruption on the program disc.

The information held on the employee record represents the standard week and assumes employees will, on most occasions, be paid on that basis. Week-to-week variations are catered for at the time of the running of the payroll.

The Payroll-200 package has been designed for use in conjunction with the tax-week year, ideally, but can be used on a calendar year. The payroll is run weekly by accessing facility P on the menu. The user is prompted for the current week number and is then offered the option of altering the standard details for each employee.

That is achieved by displaying each employee's name and payroll number and the user must opt for a standard payment, in which case the next employee is offered, or a non-standard payment. The program will then offer a data entry form for manual input of any or all of the following details:

- a. Time, normal hours in hours
- b. Overtime, 1.5 in hours
- c. Double-time in £s
- d. Bonus in £s
- e. Sick pay in £s
- f. Holiday time in hours
- g. Adjustment, miscellaneous in £s
- h. Contribution adjust NI in £s

in this case entry proceeds to

- l. Rate A contributions to date in £s
- (continued on next page)

51



(continued from previous page)

2. Rate B contributions to date in £s
3. New rate A to date in £s
4. New rate B to date in £s
5. Wage adjustments in £s

The operator may access any one field and can edit values on a similar basis to the employee edit routine. At any point, the alterations may be cancelled and a standard week chosen. Once complete, the system moves on to the next employee on disc.

Sequential vetting

The sequential vetting of each person on the payroll proved to be the only element in the system where we felt that an improvement could be made. The access time combined with internal-processing time meant that some time delay occurs between each display of eligible payees.

That turned the running of each payroll into a tedious routine, particularly if no modifications were required. On a weekly basis, that is not such a major consideration but a full payroll of 200 would certainly take in excess of an hour, assuming a standard week is applied.

Once details have been entered, the program proceeds on a batch run to produce wage slips, a cash analysis, and three summary reports. The summary reports are;

- Payslip summary A showing employee's number, employee's name, normal hours, overtime hours, double-time hours, basic pay, bonus, holiday pay, sick pay, and gross pay.
- Payslip summary B showing tax, National Insurance, deductions, nett pay, adjustments, paid amount, National Insurance employer, total National Insurance employee's name, and employee's number.
- Employee details to date shows employee's number, employee's name, gross, tax free, tax paid, National Insurance employee, deductions, payable, and National Insurance total.

Each of the reports lists the employees in sequential numerical order and are very simple in design. The payslips are more than adequate for detail and do not require detailed pre-printed stationery although a boxed format makes the slip more legible. Stationery is available from ACT.

Report information

There is no output for those employees to be paid by cheque or credit transfer, nor are they shown separately on any of the reports. Given that there will not be many users wanting this facility, it is not critical, but it would be advantageous if those to be paid in either manner were flagged on the reports to aid in the preparation of payments.

A highly-useful and well-thought-out feature provided is the ability to halt the payslip-print program at any point with a

variety of options offered to the operator to cover most needs. An abort menu appears if printing is halted and the user may

- a. Press 'R' to re-start all wageslips.
- b. Press 'C' to cancel all data.
- c. Press 'A' to amend one wageslip.
- d. Press 'B' to exit from the program.
- e. Press 'M' to return to the menu.
- f. Press '*' to continue the print run, or Press a number i.e., X to reprint the last X wageslips.

If abort mode is entered, the system finishes the payslip being printed currently before offering the options. According to the option chosen, the system responds with an appropriate message, i.e., please wait — aborting calculations.

Variable details

On amendment and exit, the system records those employees for whom slips have been produced and will re-issue them on subsequent runs. A complete abort will reverse all calculations and return control totals to their previous values.

Variable pay details have to be re-entered in that case. The re-do facility is for use with the amend option under abort, or as a rehash of an erroneous payroll run.

The month-end routine accessible from the main menu is a simple summary

NAME:	← NO: 12
HOURLY RATE	0.00
NORMAL BONUS	0.00
NORMAL HOURS	0.00
ANNUAL HOLIDAY (HOURS)	0.00
TAX CODE	PAYMENT METHOD
TAX WEEK 1? V/N	CREDIT TRANSFER
N.I. RATE	CHEQUE
N.I. NUMBER	CASH
PREVIOUS EMPLOYMENT	GROSS PAY
	TAX PAID
	0.00

routine which produces a tabular report showing; employee's number, employee's name, gross, tax, National Insurance employee, payable, and National Insurance total. It will also clear any employees whose details have been deleted since the last month-end run. The month-end routine is not geared specifically to the calendar and will report according to the interval since the last month-end.

The year-end is a clear-down facility which zeroes accumulated values for gross pay, tax, and National Insurance contributions. Each employee's details are displayed to the operator and any holiday time left over is shown with a request for the new number of holiday hours for each person. Each payee is dealt with and the system is ready to run for another year.

The list-employee-details routine is exceedingly useful and produces a full page of all details stored, weekly monthly and total-to-date values. The information is a summary of the payroll activity to date and, therefore, can be run infrequently. The routine prints details for

all employees; there is no individual selection.

The password may be altered at any time through the menu option and the changed password may be either committed to disc or left in core for the day's processing.

A very important feature within the suite is the disc-copy facility and users are advised to make use of the back-up option each week. The beauty of the system is its simplicity. The working storage or data disc is always used as the master and the copy disc only as back-up. Should it be necessary to revert to the copy disc, this is in turn copied back on to the master disc.

Many other commercial packages base their operation on an old and new generation of discs which means that users must be careful to label discs properly and to operate a strict rotation system. The design of Payroll-200 means that the same two discs are always used and never dismounted in the course of normal processing.

Budget amendment

Due to the varying nature of governmental economic policy over the longer term, the very necessary ability to alter tax code values on a global basis has been provided. The budget amendment routine allows the user to enter values, positive or negative, to be applied to each of the four code types where that is permitted, i.e., H,L,P or V. Other code types can be altered through the edit employee detail option.

The standard of documentation is very high with a variety of sections covering not just the running methods but also details on amendments to cumulative fields and the implications of such actions; error conditions and corrective measures; and calculation methods used in the payroll.

The user is not permitted to alter the rate of taxation or National Insurance deductions without first consulting the authors who run an update service for such variations in legislation.

Conclusions

- The standard of the software is far superior to many of the commercial offerings on the market, despite minor anomalies.
- For £50 Payroll-200 is good value for money for those with a small and simple requirement and where cash payments are the standard.
- The level of reporting is also simple and could do with a few minor improvements.
- Good use of graphics and design make data entry simple and secure through interactive forms.
- Payroll runs involve the operator in more time than is necessary but allow for simple modification of standard values for each employee.
- Security has been skilfully devised and applied.

Buy a microcomputer for under £1,000 and you could be on your own! Unless it's a Commodore PET.



Commodore produce Britain's number one microcomputer. But we don't stop there. We also insist on providing comprehensive support throughout our national dealer network.

Our dealers can examine your needs and demonstrate which hardware and software will suit you best. Their trained engineers are always at hand and a 24-hour field maintenance service is available. Your local dealer can tell you more about the following Commodore Services.

The Commodore PET ☛

The Commodore PET computer range covers everything from the self-contained unit at under £500 to complete business systems at under £2,500.

Commodore Business Software and Petpacks ☛

Our software range covers hundreds of applications. Business software includes Sales and Purchase Ledgers, Accounting, Stock Control, Payroll, Word Processing and more. In addition over 50 Petpacks are available covering such titles as Strathclyde Basic Tutorial, Assembler Development System, Statistics, plus our Treasure Trove and Arcade series of games.

Commodore Approved Products ☛

Compatible products of other manufacturers with Commodore's mark of approval are also available.

Commodore Courses ☛

Commodore offer a range of residential training courses and one day seminars. An excellent start. And when you have installed your system the PET User's Club Newsletter can keep you informed of new ideas and latest developments.

LONDON AREA

Add Computers Ltd.
W1 01-408151
Add Computers Ltd.
W5 01-579 5845
Advanced Management Systems.
EC2 01-638 9319
Byteshop Computerland.
W1 01-635 0647
C.S.S. (Business Equipment) Ltd.
E8 01-254 9293
Capital Computer Systems.
W1 01-637 5551
Centalex London Ltd.
SE13 01-318 4213
Cream Microcomputer Shop.
HARROW 01-863 0833
Da Vinci Computer Shop.
EDGWARE 01-952 0526
L.E.J. Computers.
NW9 01-204 7525
Home and Business Computers.
E12 01-472 5107
Merchant Systems Limited.
EC4 01-353 1464
Metyclean Ltd.
SW1 01-828 2511
Micro Computation.
N14 01-882 5104
Micro Computer Centre.
SW14 01-878 3205
Sumlock Bondain Ltd.
ECL 01-250 0505
Sumlock Bondain Ltd.
EC4 01-626 0487
T.L.C. World Trading Ltd.
WC2 01-839 3894
TOPS TV LTD
SW1 01-730 1795

HOME COUNTIES

G. M. Marketing.
ANDOVER, 790922
HSV Microcomputers.
BASINGSTOKE, 62444
MMS Ltd.
BEDFORD, 40601
Flex Systems Ltd.
BRACKNELL, 52929
DDM Direct Data Marketing Ltd.
BRENTWOOD, 29379
Ampicon Micro Systems Ltd.
BRIGHTON, 562163
RUF Computers (UK) Ltd.
BURGESS HILL, 45211
T & V Johnson (Microcomputers Etc) Ltd.
CAMBERLEY, 20446
Cambridge Computer Store.
CAMBRIDGE, 65334
Wego Computers Ltd.
CATERHAM, 49235
Dataview Ltd.
COLCHESTER, 78811
South East Computers Ltd.
HASTINGS, 426844
Alpha Business Systems.
HERTFORD, 57423
Brent Computer Systems.
KINGS LANGLEY, 65056
Isher-Woods Business Systems.
LUTON, 416202
South East Computers Ltd.
MAIDSTONE, 681263
Micro Facilities Ltd.
MIDDLESEX, 01-979 4546
J.R. Ward Computers Ltd.
MILTON KEYNES 562850
Sumlock Bondain (East Anglia) Ltd.
NORWICH, 26259
T & V Johnson (Microcomputers Etc) Ltd.
OXFORD, 721461
H.S.V. Microcomputers.
SOUTHAMPTON, 22131
Super-Vision.
SOUTHAMPTON, 774023
Xitan Systems Ltd.
SOUTHAMPTON, 38740
Stuart R Dean Ltd.
SOUTHEND-ON-SEA, 62707
The Computer Room.
TUNBRIDGE WELLS, 41645
Orchard Electronic.
WALLINGFORD 35529

Petalect Ltd.
WOKING, 63901
Oxford Computer Systems.
WOODSTOCK, 811976

MIDLANDS AND SOUTH HUMBERSIDE

Byteshop Computerland.
BIRMINGHAM, 622 7149
CPS (Data Systems) Ltd.
BIRMINGHAM, 707 3866
Camden Electronics.
BIRMINGHAM, 773 8240
Computer Services Midlands Ltd.
BIRMINGHAM, 382 4171
Catlans (Computers) Ltd.
BURTON-ON-TRENT, 812380
Ibek Systems.
COVENTRY, 86449
Jondane Associates Ltd.
COVENTRY, 664400
Davidson-Richards Ltd.
DERBY, 366803
Caddis Computer Systems Ltd.
HINCKLEY, 613544
H.B. Computers.
KETTERING, 83922
Taylor-Wilson Systems Ltd.
KNOWLE, 6192
Machsize Ltd.
LEAMINGTON SPA, 312542
Office Computer Techniques Ltd.
LEICESTER, 28631
Lowe Electronics.
WATLOOK, 2817
Betos (Systems) Ltd.
NOTTINGHAM, 48108
Byteshop Computerland.
NOTTINGHAM, 40576
Keen Computers Ltd.
NOTTINGHAM, 583254
Tekdata Computing.
STOKE-ON-TRENT 813631
Systems Micros.
TELFORD, 460214
McDowell Knagg & Associates.
WORCESTER, 427077

YORKSHIRE AND NORTH HUMBERSIDE

Ackroyd Typewriter & Adding Machine Co. Ltd.
BRADFORD, 31835
Allen Computers.
GRIMSBY, 40568
Microware Computers Ltd.
HULL, 562107
Microprocessor Services.
HULL, 23146
Holdene Ltd.
LEEDS, 459459
NSC Computer Shops Ltd.
LEEDS, 788466

South Midlands Communications Ltd.
LEEDS, 782326
Yorkshire Electronics Services Ltd.
MORLEY, 522181
Computer Centre (Sheffield) Ltd.
SHEFFIELD, 53519
Electronic Services.
SHEFFIELD, 668767
Hallam Computer Systems Ltd.
SHEFFIELD, 663125

NORTH EAST

Dyson Instruments.
DURHAM, 65937
Currie & Maughan.
GATESHEAD, 774540
Wards (Office Supplies) Group.
GATESHEAD, 605915
Ehton Ltd.
HARTLEPOOL, 61770
Fiddes Marketing Limited.
NEWCASTLE, 81517
Newcastle Computer Services.
NEWCASTLE, 615325
Format Micro Centre.
NEWCASTLE, 21093
Tripart Associated Systems Consultants Ltd.
SUNDERLAND, 73310

SOUTH WALES AND SOUTH COUNTRY

Radan Computational Ltd.
BATH, 318483
Computer Corner.
BAYSTON HILL, 4250
Bristol Computer Centre.
BRISTOL, 23430
C.S.S. (Bristol) Ltd.
BRISTOL, 779452
T & V Johnson (Microcomputers Etc) Ltd.
BRISTOL, 422061
Sumlock Tabdown Ltd.
BRISTOL, 26685
Sigma Systems.
CARDIFF, 34869
Office and Business Equipment (Chester) Ltd.
DEESIDE, 817277
A.C. Systems.
EXETER, 71718
Micro Media Systems.
NEWPORT 59276
J.M. Computer Services Ltd.
NEWQUAY, 2863
Devon Computers.
PAIGNTON, 526303
J.A.D. Integrated Services.
PLYMOUTH 62616
Business Electronics.
SOUTHAMPTON, 738248
Computer Supplies (Swansea).
SWANSEA, 250047

NORTH WEST AND NORTH WALES

Tharstern Ltd.
BURNLEY, 38481
B+B (Computers) Ltd.
BOLTON, 26644
Preston Computer Centre.
PRESTON, 57684
Catlans (Computers) Ltd.
WILMSLOW, 527166

LIVERPOOL

Aughton Microsystems Ltd.
LIVERPOOL, 548 7788
B.E.C. Computers.
LIVERPOOL, 263 5738
Rockcliff Brothers Ltd.
LIVERPOOL, 521 5830

MANCHESTER AREA

Byteshop Computerland.
MANCHESTER, 236 4737
Computer Store Ltd.
MANCHESTER, 832 4761
Cytek (U.K.) Ltd.
MANCHESTER, 872 4682
Executive Reprographic Ltd.
MANCHESTER, 228 1637
N.S.C. Computer Shops Ltd.
MANCHESTER, 832 2269
Sumlock Electronic Services (Manchester) Ltd.
MANCHESTER, 834 4233
Professional Computer Services Ltd.
OLDHAM, 624 4055
D. Kipping Ltd.
SALFORD, 834 6367
Automated Business Equipment Ltd.
STOCKPORT, 061-432 0708

SCOTLAND

Holdene Microsystems Ltd.
EDINBURGH, 658 2727
Microcentre.
EDINBURGH, 556 7354
Aethon Consultancy Services.
GLASGOW, 641 7758
Byteshop Computerland.
GLASGOW, 221 7409
Robox Ltd.
GLASGOW, 221 5401
Mac Micro.
INVERNESS, 712203
Thistle Computers.
KIRKWALL, 3140

IRELAND

Softech Ltd.
DUBLIN, 784739
Medical & Scientific Computer Services Ltd.
LISBURN, 77533

To: Commodore Information Centre,
360 Euston Road, London W1 3BL. 01-388 5702

Please send me further information about the Commodore PET.

Name _____

Position _____

Address _____

Intended application _____

P.C.D.I.

Do you own a PET? YES NO

Commodore

This list covers Dealer participating in our advertising.

Sharp PC-1211

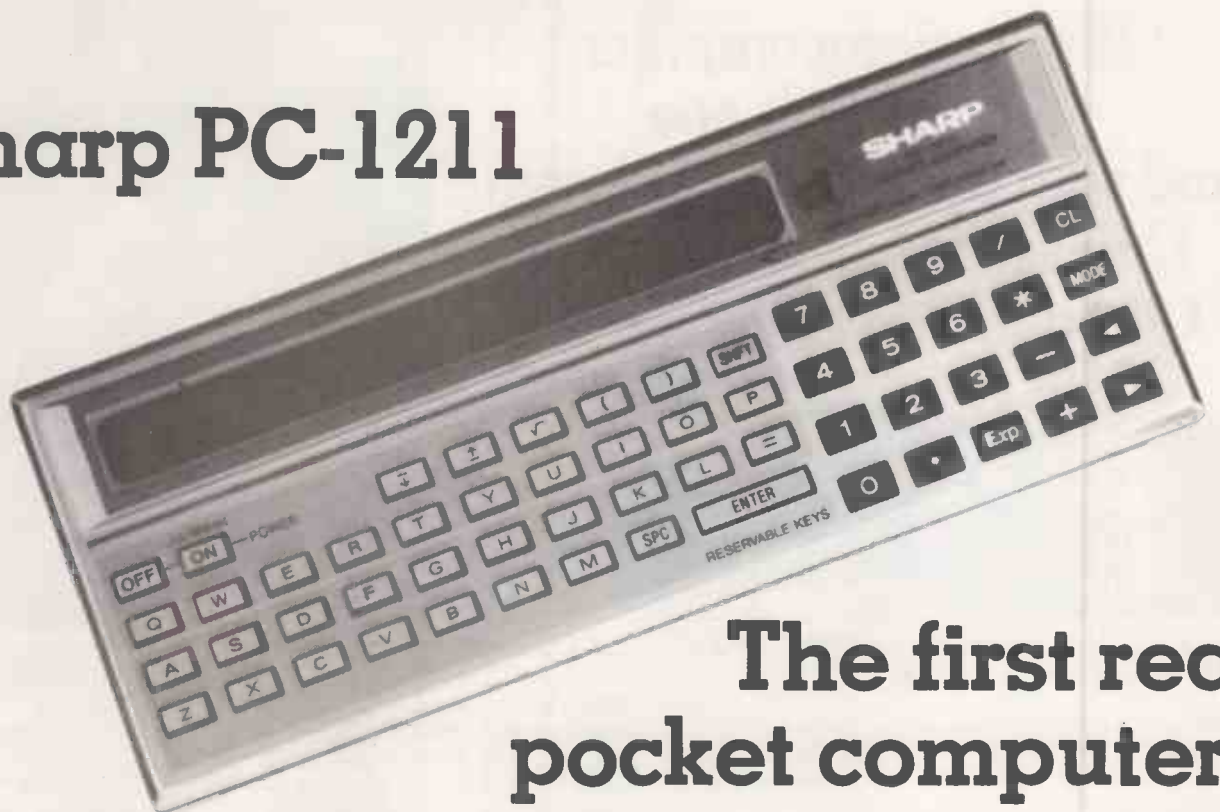

The first real pocket computer?

WEIGHING in at around 170 gm. and measuring a mere 175 × 70 × 17 mm., the contender for the title of the first genuine pocket computer has come forward in the shape of the Sharp PC-1211. To be perfectly correct, it has only almost arrived because this exciting little pocket marvel is not yet on the U.K. market. When it is available, it will retail for around £110.

At first sight, the instrument seems to be a conventional scientific calculator with a slightly oversize display. Closer inspection shows how wrong first impressions can be. The 57-station keyboard is fully alpha-numeric with the alphabet laid-out in standard QWERTY format — obviously scaled-down — and with a convenient pad of numerals and mathematical functions, + — * and /, on one side.

A shift key allows a useful range of punctuation as well as special functions, and there are a number of control keys allowing selection of operating mode, cursor control and edit operations.

Character font

The liquid crystal display consists of 24 character positions each built-up as a 7 × 5 dot matrix. The character font is limited to upper-case with numerals and punctuation. Characters are entered on to the display from left to right — conventional typewriter mode — and when the 24 positions have been filled, the single-line display scrolls from right to left until the maximum permitted number of characters, 80, is reached. At any time, the two horizontal cursor control keys allow back or forward spacing for editing, correcting or re-reading anything which

may have been scrolled out of sight.

The computer has a memory capacity of 1,424 steps which seem to equate to bytes and a resident Basic interpreter containing 15 mathematical functions, 21 statements, six commands and six control statements — table 1.

In addition to that, the interpreter operates with 10-digit precision for the mantissa with a two-digit exponent. The computational limits range from 1×10^{-99} to $9.999999999 \times 10^{+99}$, positive or negative.

Basic interpreter

The interpreter approximates to a shortened form of standard Basic and can be used in a matter of minutes by anyone with a modicum of experience with Basic. It has some unusual features — a pause statement which is used as an alternative to print for repetitive printing of successive results.

That provides an option to the user of an automatically-stepping result or a displayed result which remains until the next result is requested by depressing the enter key. That feature is very necessary on a computer which has only one line of display, i.e., no vertical scroll.

The other novel feature is the ability to branch to a line defined with a label contained within quotes. For example, one could have the following two lines somewhere within the program:

```
50 IF A = B THEN "FINISH"
```

```
90 "FINISH" PRINT "FINISHED"
```

The feature is an extra and the usual method of branching to a line number or integer result of a function is also

a standard feature of the new PC-1211.

Numerical variables exist as two forms which the manual describes as fixed memory and flexible memory. The former are the 26 letters of the alphabet which are defined in the usual way as A, B, C etc., but can be equally defined as A(1) to A(26). That is, variable B and A(2) are one and the same which allows one to refer to variable B as A(4 * SIN 30) just as one would an array.

The 26 variables are called fixed memory variables because their presence is always guaranteed, as opposed to the variables defined as A(27) and onwards which can exist only if sufficient memory is available — each of the latter flexible memory variables require eight bytes of memory.

String variables

Any of the fixed or flexible memory variables can be used to hold a seven-character string by inserting the usual dollar sign after the variable's letter. Note, A and A(dollar) cannot coexist. Although string variables exist, there is very little scope for their manipulation apart from rudimentary conversation.

The computer operates in any one of four modes which can be selected by a key. They are PROGRAM, RUN, DEFINE and RESERVE. The first two are self-explanatory but the latter two are unusual. As well as the operating modes, the computer can handle angular measurement in degrees radians or grads and these units can be changed on the fly by using the statements DEGREE RADIANT or GRAD in programs.

When the computer is set to RUN mode, it may be used to execute

IMMEDIATE instructions entered through the keyboard as if it were a conventional calculator. Complex chain calculations involving trigonometrical functions and several levels of parentheses are possible. The machine, of course, comes into its own when executing programs.

Program entry

Entering a program is simplicity itself — select PROGRAM mode, type in a line number and go ahead with Basic. At any time while preparing a line for entry, you can back-space the cursor to correct and, if you are lazy, you can enter abbreviated keywords which the interpreter translates and displays in full as soon as the enter key is depressed.

Once a line is entered, you can type a new line number and continue programming as if you were operating a conventional machine. Two vertical cursor control keys allow recall of lines behind or in front of the one being worked which, in conjunction with the horizontal cursor control keys, constitute a quick and powerful editing system.

The interpreter is very economic as far as memory utilisation is concerned — each statement is converted to a single byte code and only three bytes are used to define the line number which can be in the range one to 999. Thus the statement 10 FOR A = 1 TO 10 uses 10 bytes of memory. At any time, the command MEM will display the number of bytes of spare memory and the number of flexible

memory variables to which it is equivalent.

Once a program has been prepared, the mode key should be depressed to bring the machine into the RUN mode and the command RUN entered. The program executes in the same way you would expect to see on a big brother machine. The only difference — and it is a major difference — is the speed. It is painfully slow. A few off-the-cuff tests showed that a single multiplication takes approximately 50mS and a SIN calculation 600mS. Quite clearly the internal hardware is calculator-orientated.

High precision

That is illustrated even more by the speed of straightforward interpretation without any significant calculation. An empty FOR NEXT loop takes approximately 230mS, a quarter of a second, per single step cycle. None the less, that should not be held against the machine. It is of extremely high precision and is definitely not a toy. Its application is scientific and for many applications its low speed will be unimportant.

When a program has been entered and run and the machine switched-off, the user should be ready for a big surprise. Switch the power-on again and type RUN. Low and behold, the original program is still contained in the machine's memory — even after power-down. This very practical use of low-standby-power memory is a spectacular feature of the PC-1211.

For dedicated applications a complex

Functions, statements and commands

Functions

SIN	COS	TAN	ASN	ACS	ATN
LN	LOG	EXP	√	DMS	DEG
INT	ABS	SGN			

Note: DMS converts decimal fractions of degrees to minutes and seconds. DEG converts degrees minutes and seconds to decimal fractions of degrees.

Statements

LET	INPUT	PRINT	PAUSE	USING
GOTO	IF	THEN	GOSUB	RETURN
FOR	STEP	NEXT	STOP	END
BEEP	CLEAR	DEGREE	RADIAN	GRAD
AREAD	REM			

Note: PAUSE is a repeating PRINT statement; USING formats a PRINT statement by specifying decimal places etc. BEEP sounds an internally-generated audio tone.

Commands

RUN	DEBUG	CONT	LIST	NEW
MEM				

Control

CSAVE	CLOAD	CLOAD?	CHAIN	PRINT #
INPUT #				

Note: All the CONTROL statements are associated with the tape I/O operations.

program can be typed in once and left inside the machine for as long as the batteries last in standby mode, that time is not quoted in the manual but must be quite significant because during normal operation the battery life is stated as 300 hours.

Another interesting point is that if the machine is accidentally left switched on for more than seven minutes without any operating taking place, it reverts to low-power standby mode automatically to conserve battery power.

Error codes

Apart from its speed I had no quarrel with the Basic interpreter — there did not appear to be any bugs and all deliberately-introduced error conditions were suitably flagged by one of the six designated error codes. Its 10-digit precision makes it valuable for sophisticated mathematical and scientific applications.

It was, however, rather surprising that no provision is made to generate random numbers. Probably as a result of memory limitations it is only possible to nest four levels of subroutine and four FOR NEXT loops but for the types of calculations to be undertaken by such a machine, that is probably of no major concern.

The disadvantages are more than outweighed by other useful features, for the scientist, the DEFINE and RESERVE operating modes would prove most attractive. The DEFINE mode assumes the role of running a program from any starting line — identical to the use of GOTO as a command on a larger machine.

Where it differs is that any of 18 keys on the keyboard can be designated as corresponding to any 18 line numbers

(continued on next page)

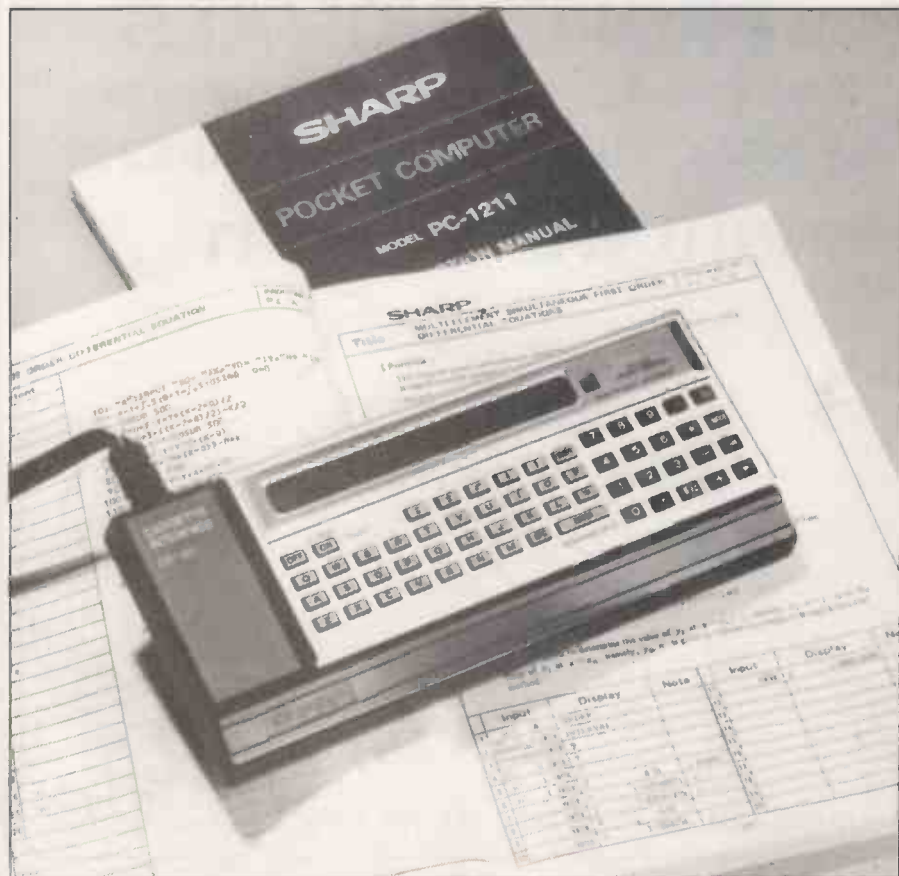



(continued from previous page)

contained within a program. That is done by using the key's character as a label within quotation marks immediately after the line number in question. When operating in DEFINE mode it is necessary only to press the shift key and the appropriate designated key to run a program from that pre-defined line number.

It is, therefore, possible to have up to 18 reasonably complex programs residing within the machine's memory at any point and any of them can be run on demand simply by depressing the appropriate key. Coupled with the power-down memory

protect, it is a very powerful feature for applications requiring complex repetitive calculating — for example, surveying or structural design.

The RESERVE mode allows one to use any of the same 18 keys to call a previously defined function, expression, statement or constant. For example, if the function

$$4 * 3.141592654 * R \wedge 3/3$$

is required several times, it is much easier to type it once and then reserve one of the selectable keys for it.

Whenever the function is required it is necessary to depress only the key in

question and the whole function is entered as a single operation. As with the rest of memory, the reserved keys maintain their designations even during power-down.

The 100-page instructional manual is well presented and easy to follow — even though it is sometimes necessary to re-read a few sentences which have suffered in Japanese-to-English translation. A comprehensive applications manual is also available which contains 128 fully-documented programs — mainly of a scientific nature but 10 games have found their way into its pages.

Conclusions

- The PC-1211 is an impressive little machine.
- If it does materialise at the expected price of £110, it will be good value for money to someone who has the right type of application.
- Although it is small and easily mistaken for a calculator, it is powerful and is not a toy.
- Those who want a fun machine might perhaps think twice before going for it — it is slow and the display is not really suitable for games.
- For the scientist, development engineer, designer, statistician or mathematician, it is a first-rate instrument.
- It needs to be seen and used for real applications to appreciate its versatility.
- The more it is used, the more impressive its features become. M

SOFTWARE by the PROFESSIONALS



ARE YOU FED UP WITH WADING THROUGH THE SOFTWARE JUNGLE???
CAN'T YOU FIND ANY REAL BUSINESS SOFTWARE???

STOP LOOKING!!! WE'VE GOT IT

If you're looking for a £50 business package or games DON'T call us.

We are one of the foremost micro-computer applications 'Software Houses' in the country and our packages developed for the UK, offer facilities normally found only on larger and more sophisticated computer systems.

The packages are simple to use, robust, secure against crashing, extremely flexible and cover most of the normal requirements of a small business.

We provide a 12 month warranty, with all our software products, plus advice, support and backup.

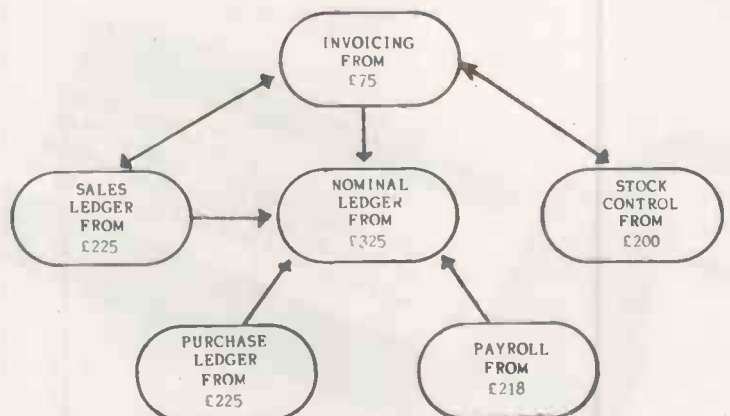

TRIDATA MICROS LTD.,

SMITHFIELD HOUSE, DIGBETH, BIRMINGHAM B5 6BS TEL. 021 622 6085



• Circle No. 158

OUR SYSTEMS CAN GROW ON YOU

When you buy one of our low price microcomputer development systems you not only get a fully burnt-in and tested system designed and manufactured to industrial standards. You also get access to an ever-increasing range of software tools. And if you require a VDU or printer now or later, there is a selection of these and other peripherals from which to choose. So your system can grow and grow.

Our systems start to grow on you at £1450. This buys you a 32KB system with dual 5¼ inch double density floppy drives. At £1675 you can have a 48KB system or for £2495 one with the extra memory storage provided by dual 8 inch double density floppy drives. All the systems are based on the powerful Z80 microprocessor and S100 bus structure and can provide memory management. Cartridge disc drives are available providing up to 40MB of storage.

The prices include an operating system and language, in this case CP/M and C-BASIC, to give a typical system cost. But with slight cost adjustment the software options are:

Operating Systems

- CP/M ● PASCAL ● CAP MICROCOBOL BOS
- Multi-User, Multi-Tasking Operating Systems

Languages

- C-BASIC COMPILER ● M-BASIC ● FORTRAN-80
- COBOL-80 ● PASCAL ● CIS-COBOL

There is also a word and text processing system available that is ideal for report writing.

You simply take your pick from the software options. Or visit our London showroom and see the systems demonstrated.

SYSTEMS WITH CP/M AND C-BASIC:	32KB + Dual 5¼ inch Floppies:	£1450
	48KB + Dual 5¼ inch Floppies:	£1675
	48KB + Dual 8 inch Floppies:	£2495

Prices exclude VAT.
Nationwide maintenance facilities available.

EQUINOX

COMPUTER SYSTEMS LTD.

Kleman House, 16 Anning Street,
New Inn Yard, London EC2A 3HB
Tel: 01-739 2387/9 & 01-729 4460

• Circle No. 159



Inside the Sinclair ZX-80

A MASSIVE advertising campaign heralded the arrival of the new personal computer from the Sinclair stable and in its wake, many wonder to what extent the claims made for the system are valid in terms of power and potential.

The device is available either in kit form or ready-made. The system under review falls into the second category and was complete with power lead and coupling cables for connection with the aerial socket of a standard television set and 3.5mm. jack leads for a cassette recorder.

The power lead has a 3.5mm. jack at one end and a rather bulbous 13A, three-pin plug on the other which contains the gear necessary to produce the 9V at 600mA which the unit requires. On opening the box, it was good to find that it had been designed to facilitate instant computing.

First impressions

The computer measures approximately 215mm. x 175mm. x 400mm. overall height and my first impression, which proved to be wrong, was one of fragility — the keyboard end tapers to a mere 7mm.

Photographs of the case design and, in particular, of the keyboard give totally the wrong impression — it is much smaller than expected, with the keys on the typewriter-style keyboard on 14mm. centres.

Supplied with the hardware is a substantial, 128-page book, entitled ZX-80 Operating Manual. It contained the inevitable loose errata sheets, one of which offered extra advice on the use of a tape recorder. The presentation of the book is first class — glossy, full-colour cover and clearly-laid-out, well-printed pages throughout with a strong, spiral wire binding. A quick look through the first two chapters confirmed that it was just a matter of plugging-in and switching-on.

To start the unit required the insertion into the socket at the back of the computer of the aerial lead to the television and the 3.5mm. plug of the power lead. There are three sockets, all identical in appearance. The sockets had designations beneath the case which were difficult to see but the manual assured me that no damage would be done if I plugged into the wrong one.

The automatic power-on, re-set worked perfectly and on tuning to channel 36, I

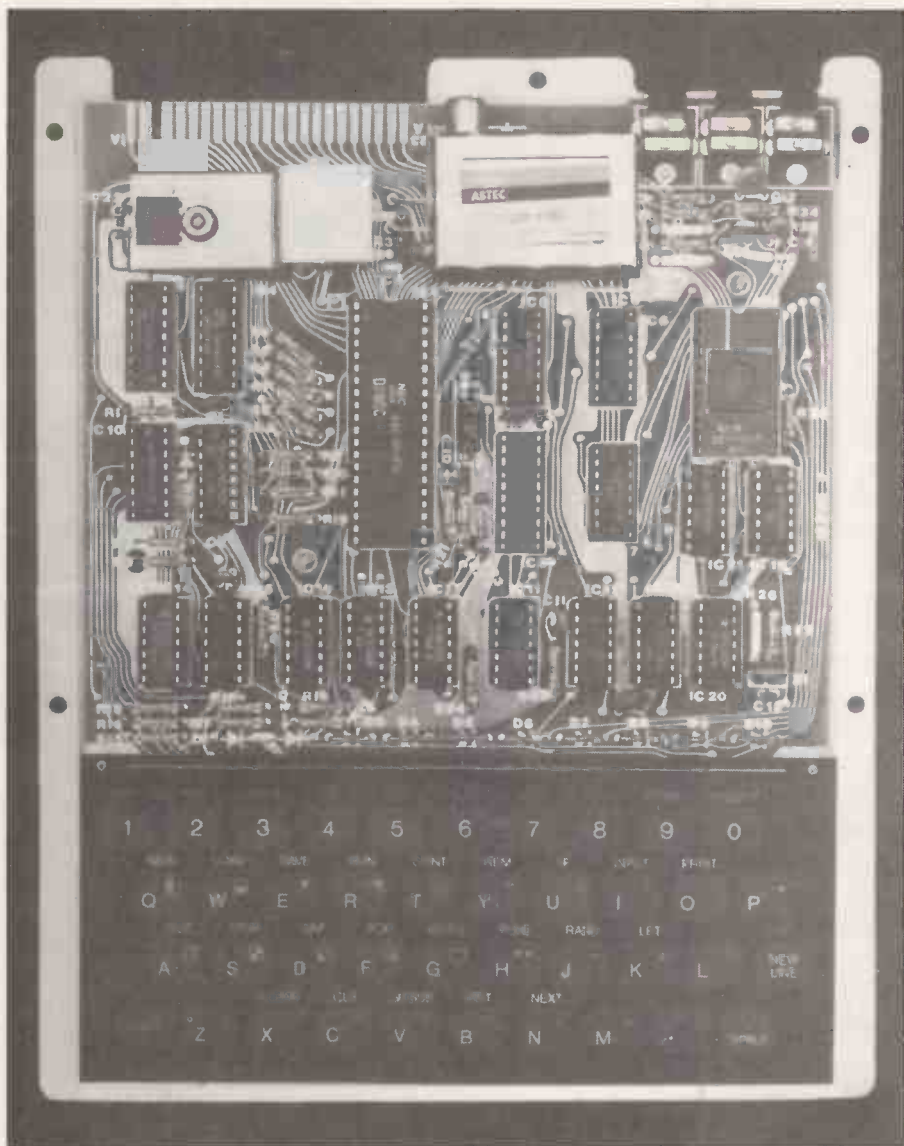

obtained a clear screen with a strange-looking black cursor containing a reversed-out letter K in the bottom-left-hand corner. Excitement took over and without further reference to the manual, I decided to plunge straight into Basic. That was a mistake.

Cunning firmware

Because of the novel method of entering keyword statements and the automatic syntax check as you enter a line, strange, but interesting, things happen. Most of the keys have three options associated with them. In an unshifted condition, they produce upper-case characters while "Shift" will give a range of graphics and punctuation. The third option is produced by a fiendishly-cunning trick in the system's firmware which recognises when the syntax requires a statement word, e.g., LET.

In my ignorance, I quickly typed in 10 LET A=123. The screen flashed each time I hit a key but at that stage I attributed it to a bad TV connection. When I checked my message on the screen I saw 10 ? (S)ET=123. The "S" in brackets refers to a reversed-out S on a black

square. Having established that the machine was alive and producing communication — even though it was rubbish — I reverted to the instruction book to learn the error of my ways.

Immediately after a line number is declared, the system expects to see a statement and is waiting for the key associated with that statement to be depressed. I had spelt LET in full but what I should have done was simply depress the key "K". The full word LET then appears miraculously on the screen in the correct place and with perfect spelling. The reversed-out "S", which I had seen, signalled a syntactic error.

Unusual method

It took an hour or so to become used to the unusual method of entering through the keyboard but I never became accustomed to the screen flashing each time I hit a key — it was not a loose connection but another example of clever design. The ZX-80 microprocessor is servicing the television-display refresh constantly in real time and only breaks-off to poll the keyboard during a quiet period — presumably during field blanking.

If no key is depressed the system monitor quickly returns to maintaining the display. If you depress a key, however, the system has to start "thinking" and momentarily ceases to service the display — hence the flicker which in some cases can cause poorly-adjusted television sets to lose synchronisation for a second or two.

During long calculations, or where loops are involved, that can be very disconcerting as the whole screen goes blank for as long as the calculation lasts. An extra disadvantage is that the screen will not scroll.

If you run a program which produces more than a screenful of text, the system defaults when the bottom line is reached. The only way of overcoming the problem is to build a software line-counter into the program and go to an INPUT loop every 22 lines. The INPUT then has to be followed by a CLS, screen clear, statement before the program continues.

It would seem that the only routine which can run while maintaining a steady display is a keyboard input loop. For the same reason, it is not possible to produce animated displays, say, for games, by memory-mapping the display with POKEs. If more information was given on system timing in the manual with the addresses of the supervisory subroutines, that might be possible.

Practical reality

Although the concept of a software-controlled display is very clever and economic, I found the practical reality of it rather limiting.

The ZX-80 Basic has 34 permitted statements, functions and commands including three rudimentary string functions together with PEEK, POKE,USR and EDIT. EDIT is versatile and very easy to use, allowing access to any line in a program for simple amendment. Coupled with the cursor control keys, it is very powerful.

There was nothing unusual about any of the statements but I did note a bug or two. For example, if REM is followed by a blank line, the interpreter does not skip the line in question but interprets REM as STOP and the program terminates.

A more annoying problem is that while the statement FOR A = 7 TO 1 is accepted as syntactically correct, i.e., a downward stepping loop but note there is no STEP function, it is not interpreted. There ought to be either an error flag or a negative step.

A frustrating point is the difficulty of BREAKing from a keyboard input loop — particularly if a STRING input is expected. The normal BREAK key will not function under those conditions and the manual is not much help apart from suggesting one switches-off — thus losing the program.

It is possible to escape using the devious trick of entering a numerical function, e.g., 12345 * 12345, which will exceed the

maximum permitted integer value. It is surprising that the problem is not catered for in the firmware. Alternatively, it should have been easy to use the Z-80 NMI, non-maskable interrupt, to perform a soft re-set if an extra key had been provided.

Control commands

Rudimentary PRINT formatting is possible but there is no TAB and it is not possible to output cursor control commands through the PRINT statement. The interpreter will allow only one statement per line.

The usual arithmetic operators are present but "Not Equal To" is noticeable by its absence. I found that surprising and a nuisance. To perform a branch on an inequality, it is necessary to say "IF NOT A = etc. ." That is unusual and it might be rather difficult for a beginner to see the logic of a statement of this type.

It is possible to GOTO a function as an alternative to a discrete line number; i.e., IF A = B THEN GOTO (A + 3) * 10 and it is useful for streamlining programs. Yet I take issue with the comment on page 47 of the manual which claims that this is

unique to the ZX-80. Many Tiny Basic interpreters have this facility.

Having established that there was some very clever firmware inside the device, I wrote a program to investigate further using PEEKs. Some interesting facts emerged. The firmware PROM appears to start at address zero and occupies the bottom 4K of memory but when I looked at the bottom of the next 4K block expecting to see RAM, I saw the monitor repeated again — and again and again.

Address economy

Altogether the monitor appears to recur four times in the bottom 16K of memory. That indicated economy in address decoding and rather than waste time peeking to discover what was what, I decided to refer to the back of the manual — which I found decidedly unhelpful.

Although one is initially encouraged by the comment in the manual that it is possible to enter one's own machine-code programs, it is a major disappointment to discover it does not tell you how to reserve RAM space or, for that matter, where the permitted RAM space is likely to be

(continued on next page)



(continued from previous page)

located. After speaking to Jim Westwood at Sinclair, a little more light was thrown on the problem and I managed to write some machine code at about Decimal address 17000 — somewhere between the top of the display buffer and the bottom of the stack.

The address decoding limits the memory capability of the existing system to a total of 8K, comprising the on-board 4K PROM sitting at the bottom and a possible 4K of RAM starting a quarter way through the Z-80 maximum potential at the 16K point. That explains why the extension memory card contains 3K which I felt on reading the advertisements was an unusual amount.

With the on-board 1K of RAM, that completes the addressing capability of the machine as it stands. I am told that Sinclair has something up its sleeve to enable further memory expansion if it is considered necessary.

Tape interface

Having become used to the system, I decided it was time to try the tape interface using SAVE and LOAD. The comment "Good Luck" at the end of the relevant section of the manual did not fill me with confidence, but undaunted, I continued. As a legacy of various unhappy experiences with tape I/O problems, I have a very good-quality, stable Marantz Superscope model C205 cassette recorder which might not be typical. The SAVE operation went like a dream, but, try as I might, there was no way I could move the data back into the computer.

I tried every possible combination of recording levels and source impedances on playback to no avail. Again, I was handicapped by the manual which gave no technical data about the levels the system

expects to see; it talks only of microphone inputs and earpiece outputs.

That area is always a weak link with small micros and as much information as possible ought to be given for those who might experience trouble. I regret I had to throw-in the towel in the end. I am sure the loading system will work because the manual says it will but interfacing to my tape recorder — which I thought was a good one — was a disaster.

Little information

When faced with a situation involving a computer which works but does not do all you wish of it, it is always useful to be able to revert to machine code to do bug analysis, but there was no way I could discover why the machine refused to accept my tape input. I would have liked to patch a simple routine calling the tape input routine and then displaying the input data, byte by byte, on the display.

I was unable to do so because no information is given to identify the locations or nature of the utility routines, and even if it had been, it would have been of little use because the machine will not display while it is processing. I know that it is expecting a quart from a pint pot, but I feel it worth mentioning because it may indicate a severe limitation of application for those who are interested in low-level programming.

An initial glance at the plastic facing of the keyboard brings back recollections of the MK14 but I must say it is a vast improvement. It seems to be electro-mechanical and relies probably on a metal foil, separated from contacts on the PCB by a thin insulating film with apertures in requisite places.

I found it best to use single-finger operation because there is no two key roll-over, i.e., if you type too quickly and hit a second key before the first is released the

second character is not entered when the first finger is removed. Another reason for opting for single-finger operation was the fact that you cannot be certain that touching the designated area will cause an entry — a slight roll of the finger tip is required.

Positive action was needed on some keys which were prone to double-up the entry — probably due to hesitation in removing the finger coupled with the very thin insulator. Having made this complaint, I must admit that data entry was easy and light to the touch. The low speed of single-finger poking is compensated by the speed generated by the automatic spelling of the keywords.

Natural curiosity overcame me — I had to look inside. Without question the quality of the hardware design is beyond reproach. The double-sided PCB contains 21 integrated circuits plus a 5V regulator on a heatsink — which, incidentally, can become very hot — an Astec UHF modulator — even Sinclair has not been able to do better than this sturdy and reliable workhorse — the three jack sockets and about 25 to 35 assorted Rs, Cs and diodes.

Spacious and neat

The keyboard is integral to the PCB. The lay-out is extremely neat and tidy and, considering the size of the board, is remarkably spacious. IC sockets are used throughout and all components are designated clearly by silk screening on the board. With reasonable care, anyone with soldering knowledge could construct it.

The thing which surprised, and impressed, most was the lack of many specialised ICs. The only ones of any major consequence were the Z-80 itself, the two 2114s providing 1K of RAM and 4K PROM.

When one considers the I/O functions the system supports — VDU, tape and keyboard — with this minimal amount of hardware, one has to take off one's hat to both the hardware and software designers.

A 44-pin edge-connector at the rear of the board carries all the necessary address, data and control lines for system extension. There did not appear to be any buffers on the address or data busbars but as the system is unlikely to be expanded by more than one extra board, it is of no real consequence.

An interesting feature of the hardware is the absence of a separate character-generator ROM for the display. All the data for defining the picture-point patterns of the characters are contained within the same PROM which holds the system firmware.

I counted approximately 140 characters which represent 10 graphics symbols and the usual alpha-numerics and punctuation which were repeated in black on a white field, normal display mode, and also white within a base rectangle of black.

Apart from the cursor, the only way of

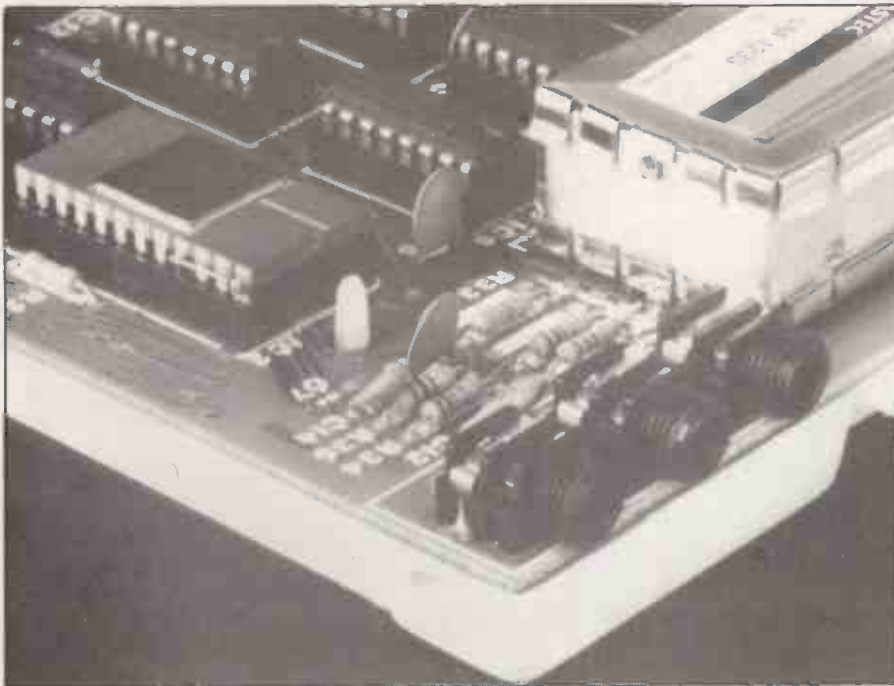

obtaining the inverse-field characters is through the firmware, using PRINT CHR \$. The graphics are very simple but, none the less, practicable and with careful thought could be used to produce reasonable resolution pictorial displays.

I use the word reasonable carefully because the advertisements I have read refer to high resolution. In my understanding, high resolution refers to single picture-point resolution — fine lines — which are not possible on the ZX-80 because each character is produced in Pixel form, i.e., the screen display is made up by stacking individual character cells together side by side or on top of each other as is the case with many single-board computers. The display consists of 23 rows, or lines, of characters and there are 32 characters per line.

Simple style

I have already touched on the production quality of the manual but I think it worth saying a little more about its content. The introductory chapters on Basic were excellent and there was obviously a conscious effort to keep the writing simple.

There were also a large number of worked-example programs, some simple and some significant, like a random dice display using graphics. Most were well illustrated with flowcharts and designed to highlight use of specific statements.

Like all attempts to telescope a pro-

gramming course into a few pages of the printed word, it accelerated rapidly but on the whole was readable and, I would have thought, for middle-aged teenagers upwards.

Where I thought the manual became decidedly confusing was in the appendices. An attempt is made to define the memory map in Appendix II but no addresses are given until one turns to Appendix III which gives those of the primary system variables in RAM. It was only after hours of reading and re-reading and cross referencing the two sections, that I began to see what was going on and even then, things were not perfectly clear.

I appreciate that it is a very difficult subject to explain but the manual hints that it is possible to use POKEs to write one's machine-code programs and run them with USR. It says that to do so, one should have a detailed understanding of the ZX-80.

That is very true, but I regret to say that the manual falls very short of giving one this detailed understanding — much more ought to have been said about the system firmware, particularly about the input and display routines and their timing. I would also have liked to see something said about the expansion-connector pinning and PORT addressing.

Without the detailed information, the machine is definitely limited to operating in Basic.

From an educational point of view the

manual, taken together with the hardware, is good for people who wish to understand the rudiments of programming in Basic but, be warned, do not expect to learn much about how computers work from it.

Conclusions

- In kit form at £79.95, the ZX-80 is very good value for money but because the sacrifices made in designing to a price, the £100 for a ready-built model may be less advantageous.
- It is a beautifully-designed machine especially for use as an educational super-toy.
- Its price will be attractive to teachers and PTAs.
- It will certainly help to bring extra keyboards within the range of young fingers, provided there are enough television sets available.
- Yet my experience of computing in schools suggests that it may not have the capacity to handle the sophistication required by examination courses.
- A hint is made that the purchase of a system could be classed a business expense but I think its business applications may be limited, not least because of its integer-only Basic. In certain cases, a good, programmable calculator might be much better, more convenient and quicker to use in the office.
- Many people will find interest and satisfaction from owning a ZX-80. □



Computer Gamble?

Visit Cambridge Computer Store and load the dice in your own favour! We have one of the biggest selections of micro-computers and peripherals in the country and the expertise to help you choose the right system. Most of the equipment listed below you can see on demonstration and buy off the shelf:

TANDY TRS 80 • APPLE • PET • HORIZON
CROMEMCO • COMPUKIT • ACORN • INFOTON
LEAR-SIEGLER • CENTRONICS • ANADEX

Back-up this impressive range with truly professional standards of advice and after-sales support and you'll take the gamble out of computer selection.

Cambridge Computer Store

1 Emmanuel Street, Cambridge CB1 1NE
Telephone (0223) 65334/68155

Birth of a system

For the non-technical reader and the computer adept alike, Mike Hughes traces the progress of a new British microcomputer, the Transam Tuscan, from initial conception through the tribulations of development to its commercial launch.

THE STORY begins in February, 1979 — about six months after the successful launch of the Triton computer. Our experience with Triton showed that there was a great need for a general-purpose, single-board micro with full documentation both for hardware and software.

We now know that the concept of the single-board computer is very sound and has had success because of its convenience and its cost-effectiveness. With good documentation, open-ended design, ease of expansion backed by extensive software support, there were orders to be won by the right kind of computer offering applications ranging from home computing to industrial process control.

In those areas, Triton proved most successful. Once Triton was off the ground, thoughts turned to a second system. We had gained considerable experience from the first machine, particularly in areas which affect marketability.

Reputation essential

To keep a customer happy and to maintain a good reputation, it is essential to deliver the goods on time. Once delivered the product must be reliable, there must be ample back-up for the customer in the event of technical difficulties and there has to be active software development.

Transam had invested heavily in stocks

to ensure fast deliveries and, by February 1979, had recruited and trained hardware and software specialists. That expertise centred, of course, on the 8080 microprocessor — the Triton central processor. It was against this background that discussions about a new system evolved.

The first problem was whether a new system should supersede the existing Transam product. That it should take the place of the remarkably successful Triton seemed unthinkable at the time. It was quickly decided that we should aim at developing a system which would be marketable alongside Triton. It would either have to fit into another market gap or offer positive advantages over other single-board computers.

Market gaps are very difficult to find in a competitive world and many weeks of investigation and discussion followed. Should we go down-market and compete with mass-selling MK14s, go up market and become involved in expensive small systems, or try and break new ground with an original concept?

At the time, the micro market could be split into roughly three zones. At the bottom end, there were low-cost evaluation kits with prices up to about £100. The middle range contained personal computers with prices ranging from £100 to £500. There was considerable overlap between the two zones depending very

much on what firmware was supplied with the machine.

The third zone started at £500 and continues upward into the thousands. It could be said that there was overlap between these two zones but, in practice the lower-priced business systems were decidedly limited in their ability to support the applications involved.

Business systems

An ideal business system requires a disc operating system built into its fundamental hardware to make it acceptable for office use. That meant that for serious business work the price bracket would have to start at £1,000.

I thought that we ought to go down market. I had played with an MK14 and, although the hardware was splendid value for money, it did not seem compatible with the market at which it was aimed — beginners.

I remember suggesting a powerful miniature single-board machine with resident Basic and a minimum chip count — just sufficient memory to provide satisfaction but with no way of expanding above about 4K. It would sell for around £100.

The attractions were that it could be developed reasonably quickly and we could use a Z-80 to help with chip minimisation while still making use of our existing 8080 firmware. A few modifi-

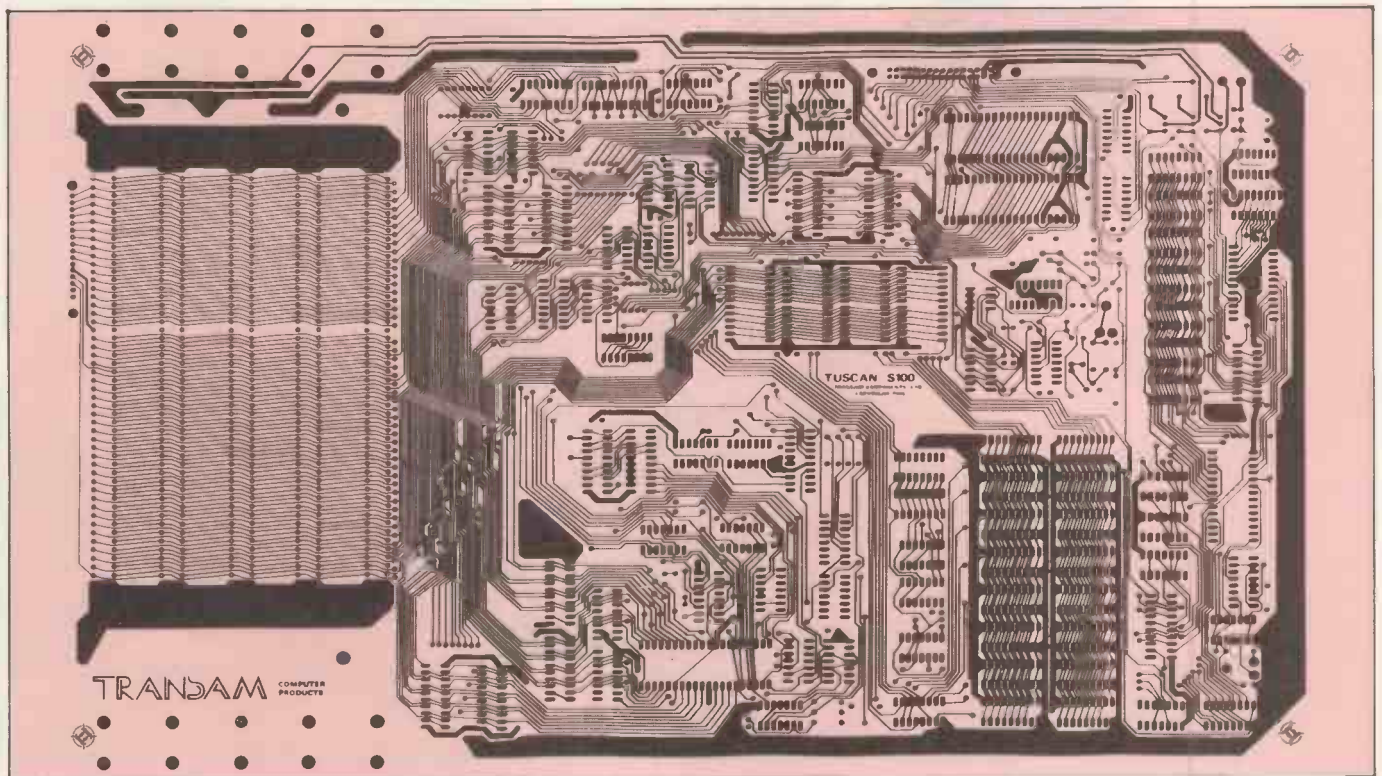



Mike Hughes, designer of the Transam Tuscan.

cations would, of course, be necessary to benefit from the more economic instruction set of the Z-80.

On reflection, however, the limitation of such a design would be that, while an ideal starting point, it would be very difficult to expand once the inbuilt limitations were reached. That would render it useless for serious applications — one doesn't stay a beginner for long.

The middle zone of personal computers contained the world's best-selling micros. Based on the single-board concept, they offered expandability, good Basic interpreters and some form of cassette or disc interface. However, closer investigation revealed weaknesses in their designs — especially for further expansion.

Design limitations

Apart from the very expensive, most lacked versatility and did not have sufficient hardware information and support to allow the user to apply them in any areas other than in those the manufacturer intended.

In addition, the software and hardware were tailored for the individual micro-computer and were not interchangeable between systems from different manufacturers.

The more expensive computers from this top zone offered compatibility and performance in terms of software; disc operating systems such as CP/M were accepted widely. The user could configure the microcomputer to his own hardware requirements with the aid of a standard bus structure, e.g., the S-100 format. That permitted interchange-

ability with other manufacturers' circuit boards.

Their problem was that to obtain a good expandable system, the user would have to spend a good deal initially — a minimum of one S-100 processor card, one video card, one I/O card, one 8K RAM card, one 8K EPROM card and a motherboard to hold them — not to mention the associated power supply.

This meant that the domestic or amateur user would be unable to afford a system which could be expanded easily and conveniently to provide, for example, vector graphics, speech synthesis, floppy disc control, standard disc operating systems and the facility for programming in several languages.

Computers which were inexpensive enough to appeal to the amateur had limited potential for real business use; systems which were capable of catering to the needs of the most exacting user would involve considerable expense initially and, therefore, did not attract the very small user.

After many meetings and pints of coffee, we began to form a picture of a single-board computer which would provide a sound, expandable base with no practical limit to the facilities available. The single-board would have to be a system capable of supporting all that is desirable on one-board machines.

It would have to be housed neatly in such a way that any further extensions would not require too many bits and pieces attached with ribbon cable.

There would certainly have to be an option offering an extended form of Basic

resident on the main board and sufficient memory. For small-scale development work and educational use, adequate provision for spare input/output facilities was needed and there would have to be an on-board video display unit.

We then asked, in what respect does this differ from what is available? The answer was simple — apart from plenty of spare I/O, not very much.

Important events

About about the same time, several important events rapidly crystallised our ideas. We had, by this time, adopted the CP/M disc operating system for Triton and Transam was well advanced in its development of an extended Basic as well as its Pascal compiler. More importantly, the S-100 busbar was finally standardised in the U.S.

Although we had previously considered the S-100 busbar, we had discarded it as an expensive and not-very-reliable way to build a system. The S-100 bus standard from Ithaca Intersystems was originally imprecisely defined and different manufacturers' boards were incompatible. However, earlier this year, the American Institute of Electrical and Electronic Engineers (IEEE) published a definitive standard for the bus. Devices that adhere to it, as the Tuscan does, should work together.

Now with the accolade of an IEEE specification, there was quite clearly going to be a wealth of interesting peripheral boards developed to this precise standard.

Whatever one feels about standard S-
(continued on page 65)

Buying Computers?

Commodore PET 32K
£675.75 plus VAT



Sharp MZ-80K
£520.00 plus VAT



ITT 20/20 16K
£623.00 plus VAT



ACT 808 inc dual
disk drive
£3950.00 plus VAT

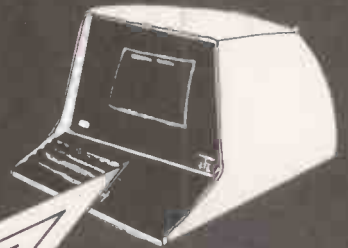

ACT 808 inc dual
disk drive
£3950.00
plus VAT

We'll give you more than a good deal

Under one roof in London's West End you can find:

HARDWARE:

A comprehensive range of hardware to meet most applications - and budgets, with terms to suit you.

SOFTWARE:

Probably the widest range of off-the-shelf software in the UK. Try out the packages and choose the one that suits you, or take advantage of our consultancy services and we will analyse, recommend, demonstrate, modify and install the programs for you.

CONSULTANCY SERVICES:

To apply micro computer systems to business, education or the home, make an appointment with our trained professionals for friendly advice based on extensive experience of discussing problems with many others like you.

MAINTENANCE AND REPAIR CLUB:

A maintenance and repair club that guarantees microcomputer users minimum downtime at very attractive premiums.

REFERENCE MATERIAL:

A library of publications covering all aspects of the microcomputer world,

including back issues of this and other important periodicals.

Whether you are an experienced micro user or a novice, looking for a system for the home, business or pleasure, the **LION MICROCOMPUTER CENTRE** is the single source to meet all your requirements.

CALL IN ANY TIME. We are open six days a week, for you to take advantage of the good deal you get when you buy from **LION**.

The above prices do not apply to account sales.



LION MICRO-COMPUTERS

SMALL COMPUTERS-TO MAKE YOUR BUSINESS BIGGER
Lion Computer Shops Ltd, Lion House, 227 Tottenham Court Road,
London W1 (First Floor). Telephone: 01-637 1601.
Telex: 28394 Lion G.
Open 9 to 6, Monday to Saturday (Thursday to 7).



• Circle No. 161

PRACTICAL COMPUTING July 1980

(continued from page 63)

100 cards, one has to admit that their generous area, 10in. × 5in., allows plenty of scope for sophisticated plug-in options, disc controllers, ROM, RAM, memory-mapped, high-resolution VDUs, speech synthesisers, digital-to-analogue and analogue-to-digital converters. It is also a very handy size for enthusiasts to use to build-up their own breadboards.

Enormous potential

The only problem was that all the S-100 systems we had seen required the CPU itself to be on an S-100 card which ran against our idea of a single-board computer. We had prepared a rough layout sketches of our embryonic single-board system — to see the size of board and we suddenly realised that they were all roughly 10in. square.

I remember Nigel Stride casually holding a 16K S-100 memory card against my sketch saying: "Why don't we extend the board a few inches and build the S-100 bus on to the end"?

It was obvious — using modern, high-density memory chips and some compact design work, it ought to be possible to build a self-supporting, single-board computer with an integral S-100 busbar which would be no larger than our existing Triton main board.

The potential of a system based on this concept would be enormous. The single-board could be built in modules, depending on the degree of sophistication the user required — or on his pocket — and with four or five S-100 cards added. With a few peripherals such as printers and disc

drives, we had the makings of a system which would be suitable for applications ranging from Mastermind to bridge design, or Chess to Satellite Navigation — not to mention stock control, word processing, dental records, veterinary accounts and the like.

Furthermore, the system would be self-contained, needing only external devices like printer, disc drive, display screen and a tape recorder. It might even be possible to build a disc drive into the system's cabinet.

There were still a number of fundamental decisions to be made. What type of microprocessor chip should we use? What ought the on-board memory configuration to be? What type of memory — static or dynamic? What kind of on-board VDU? To what extent should there be provision for spare I/O? What sort of disc operating system should we be designing for? To what extent should we provide resident firmware options as opposed to disc-originated software? What standard should we adopt for modulated serial output?

Having arrived at the idea of a single-board with integral S-100 busbar, we had to decide on the microprocessor chip. That was comparatively easy. Since we had a wealth of experience with the 8080 and a large amount of proven 8080 firmware in our own stable, our thoughts immediately turned to the Z-80.

It would be sad to turn our back on the trusty 8080 but the increased computing power, wide acceptance, low price and ready availability of the Z-80 made it the prime candidate. Furthermore, we

would be able to use all our existing machine code programs written in 8080 code, on a Z-80 system because, the Z-80 is upwards-compatible with the 8080.

That means that the Z-80 will do exactly the same things as an 8080 when it is fed with the same binary, or hexadecimal, operation codes. The Z-80 will also do far more by making use of extra codes and sets of instructions.

It is a big help to be able to use existing firmware for development because one is not confronted with the ghastly chicken and egg problem when testing out a prototype — if the system did not respond at switch on, we would know we had a hardware problem and no nasty bugs lurking in the test programs.

We only wished to use 8080 firmware for development purposes — the final Tuscan system firmware makes the best possible use of the full Z-80 instruction set.

We had already looked, in some depth, at other eight-bit microprocessors, but with software- and CP/M-compatibility in mind we chose the Z-80. This, combined with the firmly established S-100 busbar, would make Tuscan one of the most versatile low-cost computers available.

Interface problems

As the man who would have to do the design work, I was somewhat concerned about interfacing a Z-80 chip to the S-100 busbar of the IEEE specification. For the benefit of those new to the computer scene, the S-100 busbar is a set of 100 signal and power lines which carry electrical information from place to place within a computer system.

Wires on the busbar carry signals like addresses, data, control information interrupts, status information and mundane things like clock pulses and reset lines. All microprocessors require and produce such signals but there are variations in their logic and timing in different devices.

The S-100 busbar was conceived originally with the 8080 chip in mind and the Z-80 does not produce the same type of control signals. That meant I would somehow have to make Z-80 signals simulate those from an 8080 chip. Doing it was not so much the problem — given a bucketful of integrated circuits and unlimited time and space almost anything is possible. Yet would it be practicable to provide all the encoding circuitry necessary to convert to S-100 standard and leave sufficient room on the board for all the other facilities we had in mind? This was a problem to be investigated in the future when design work started in earnest.

We considered the memory system. Obviously there had to be a significant amount of ROM for firmware, as well as random access work space on the main

(continued on next page)



(continued from previous page)

board. Furthermore, the ROM would have to sit at high memory addresses with RAM starting at address zero to enable us to operate under CP/M with disc drives.

We considered that for a long time because the decision had to be made on the basis of board space, the availability of devices and the size of resident firmware we thought best for those who would not wish to go beyond a single, main-board system.

Power supply

We also had to consider the power supply we would be able to provide for the main board. Ideally, we wanted to operate with a single +5V rail and ground and we nearly succeeded.

It is virtually impossible to put on paper the permutations of arguments we went through on this subject: should the RAM be static or dynamic — there are big cost advantages with dynamic as well as speed and packing density but it is rather difficult to trouble-shoot when things don't go according to plan? Should we use easy to obtain 4K RAM chips or the more elusive, and very expensive, 8K chips? What benefits would we obtain if we used RAM chips which were pin-for-pin-compatible with EPROM chips? Should the ROM be in the form of 1K, 2K or 4K chips? The latter would give best packing density but would make the modular approach to building in firmware more expensive for those who only wanted a system with a monitor.

In true British tradition, we arrived at what we felt to be an excellent compromise. We would provide 8K of static RAM for on-board work area and 8K of EPROM organised as four 2K chips. The RAM would be organised as eight pairs of 1K × 4-bit devices.

As the memory is the most expensive single part of the computer, that would give those with shallow pockets a small system which would not cost too much but would, nonetheless, be a powerful machine which could be expanded without fuss or bother. It was a formula which had proved highly successful on Triton.

For those with less restraint on spending, a 16K machine is not to be sneezed at and the 8K of EPROM would adequately hold our extended Basic plus a modicum of supportative firmware. A system configured thus would vie with other single board systems on the market.

In considering the memory, we also had to take into account the VDU. It was tempting to make this integral with memory to allow the flexibility of a memory-mapped display but it would have entailed a considerable amount of logic to allow this to be switched-in or out as desired — or re-located to new areas as memory space was used up for other purposes.

We had also learned, from Triton, that

the use of a dedicated VDU control chip can greatly simplify design and uses less board space. We also had in mind that many people might wish to use our proposed S-100 bus to add a sophisticated VDU controller card of their own choice.

By using a dedicated chip operating as an output device — just like any peripheral — it would be easy for the whole of that section of the board to be left unassembled, if the user wished. We, decided therefore, to provide a very simple and straightforward on-board VDU which operated through an output port. Those who wanted to use a high-resolution memory-mapped S-100 VDU could use the on-board, 8-bit parallel output port for something else.

Although the VDU was to be simple, it would have to suit most practical appli-



The Transam Triton is the forerunner of the Tuscan.

cations — particularly those for business. The character font, therefore, had to be practical and sensible. It would have to contain full upper- and lower-case characters as well as sufficient graphics for drawing forms.

For special applications — particularly foreign languages work — there should be sufficient flexibility to allow character fonts to be designed to customers' specifications. We decided, therefore, to use a simply-encoded EPROM to contain the character picture point patterns. Being erasable, that can be changed to suit any application.

We needed 1,024 eight-bit bytes of memory to contain the necessary information and the obvious choice of chip was the 2508, the single-voltage rail version of the popular 2708. As this chip is produced in relatively low volume, it is inordinately expensive for its size, so for economic reasons we decided to use a 2708 and accept that we would have to provide a limited amount of +12V and -5V to drive it. With hindsight, this was not too much of a problem because we had, in the end, to provide +12V and -12V for the RS232 interface.

One has to remember that, as yet, there had been no positive steps taken in formulating a detailed design and estimates of the board space available were based solely on experience and a feel for the way the concept was developing. I was particularly worried when we came to discuss the various I/O functions which were desirable.

Because we were using a Z-80, there was considerable pressure on me to use some

of the good Z-80 family peripheral chips like the programmable I/O device and the serial I/O chip. Because we had opted to go for the S-100 busbar, all the available control signals would be encoded into 8080 format and it would have taken a fair amount of extra logic to put things back to normal for the benefit of Z-80 PIOs and SIOs.

We could have interfaced the on-board I/O with the Z-80 before the S-100 encoding system but this would inevitably have meant we would encounter DMA problems if we were to use the S-100 full set of memory access (DMA) options.

I breathed a sigh of relief when the discussion veered towards the relative costs of conventional I/O versus PIO and SIO devices. It was obviously going to be much more economic to use conventional latches and UARTs and they would more than adequately provide for most I/O contingencies.

A lesson we had learnt from Triton was the importance of providing sufficient numbers of spare I/O ports for the enthusiastic experimenter or for applications requiring hand-shaking operations. We would have to make as much use as possible, space permitting, of I/O decoding. I am happy to say that apart from Transam specifying a bare minimum of I/O facility, I was left to my own devices for this part of the board.

Feasibility study

The essential items required were a serial RS232 input and output — to interconnect with standard peripheral terminals — a parallel input port for an internal keyboard, a modulated serial I/O for use with tape recorders or communications systems and, of course, an output port for the on-board VDU. In practice, we managed a good deal more.

The bare bones of the system had now been defined — albeit on the backs of envelopes and scraps of coffee-stained paper. The date now was April 1979 and everything depended on a technical feasibility study to decide how many of the general specifications could be translated into practical reality. The problem was now well and truly mine and I was not happy. I became even less happy when I started the initial PCB lay-out. The essence of the problem was to cram the contents of five normal S-100 cards into two — the Tuscan board is about the size of two standard S-100 boards. These five were: 1 × Z-80 CPU card; 1 × 8K Static RAM card; 1 × 8K EPROM card; 1 × video display card; 1 × I/O card.

I would also have to group the various busbar rails into the logical sequence required for the S-100 bus and provide slots for five extra cards to be added as optional extras.

If this could be done, we could have a conventional S-100 system and a saving of several hundred pounds. □

Interested in the PET?

PRINTOUT is a magazine devoted solely to the PET/CBM computer. Whether you are already a PET owner, or just interested, PRINTOUT is your best source of information on the PET.

Ten times a year PRINTOUT breaks the latest news stories from the fast moving PET world. And because we specialise we cover them more fully. PRINTOUT was first to publish details and pictures of the new 8000 SuperPETs, and first to print a full evaluation. (Don't ask how we got hold of one!)

PRINTOUT's hardware and software reviews could save you a small fortune—we never pull our punches, especially about business software.

PRINTOUT also tells you about the latest peripherals—speech synthesisers, voice recognition, high resolution graphics, even colour!

PRINTOUT can help solve your programming problems too; each issue we publish pages of readers questions with answers by our resident panel of PET experts.

PRINTOUT is professionally produced, lavishly illustrated on glossy paper and packed with information. Last issue ran to 36 pages plus a special supplement on the London PET show. We are independent of Commodore.

PRINTOUT costs just 95p an issue or £9.50 for a years subscription.

IN THE LATEST ISSUE!

THE CBM JUMBO
Jim Butterfield reports exclusively for PRINTOUT on the most-awaited announcement to come from Commodore.

THE COMPANY THAT JACK BUILT
Richard Pawson did what few others have done — secured a lengthy interview with Jack Tramiel, Mr. Commodore himself.

THE HANOVER FAIR
Each year, it's the world's biggest unveiling. And PRINTOUT was there to see what Commodore was showing.

WHO DO YOU WANT TO BE?
Terry Hope ventures into the world of 16K and 32K fantasy games. Savaged and mauled, he reports on what he found there.

PETS & PIECES
The irrepressible Gavin Sanders takes his usual monthly meander round the PET scene.

PEEK & POKES
Yet another collection from Inside Trader of the things you want to know about the PET scene but never manage to find out.

PERSONAL ELECTRONIC TRANSACTIONS
Gregory Yob, acknowledged PET master, takes you round some more unexpected corners in the gentle art of PET programming.

HOT LINE
News and reports from all over, covering the things you want to know.

TOMMY'S TIPS
Tommy Turnbull, PRINTOUT technical correspondent, with an interesting and unusual way of aligning figures on-screen.

PET is the trademark of Commodore

Subscriptions are for a full volume only and start with the first issue of that volume.

PRINTOUT Greenacre, North Street, Theale, Berks RG7 5EX

I enclose: 95p for the latest issue £9.50 for one years subscription (UK only)
 £14.50 for one years subscription (o'seas) £10.50 for one years subscription (Eire)

My name is

My address is

Post code

PC7

• Circle No. 162

Call it a draw

The supermarket's sliding doors parted with a sigh to admit the stout figure of Michael George. He slipped through the entrance into the claustrophobic bustle of Saturday-morning shoppers and eyed with distaste the sign in front of him: "Shoppers beware — we always prosecute".

It was no idle threat. Remote-control cameras panned lugubriously to and fro over the figures intently plucking goods from the shelves; a bland ingratiating female voice, announcing the day's special offers, sawed at his consciousness like a blunt razor.

George pulled a trolley from the serried ranks and, gazing glassily at the list made by his wife Sarah, began to fill the trolley with the week's requisites. He glared at his fellow shoppers with disdain, wincing at each nerve-jangling crash of their trolleys and hating them for their indifference. Outwardly, this silver-haired, slate-eyed gentleman, notwithstanding his pained frown, was one of the crowd as he stood in line with his toiletries and groceries; but the exterior masked the turmoil of the Scorpio.

He was yet to show his sting; but the opportunity would soon be on him. Above the check-out, the remote cameras still swung tirelessly back and forth with apparent indifference.

At County Constabulary Headquarters, two investigators stood behind an operator in the computer room. Its air-conditioned serenity was their coulisse, and a practical one at that; for here, the world outside was subordinate to a computer keyboard. More by virtue of his forceful personality than rank, Superintendent Walsh was the department gnomon, round whom lesser personalities revolved with the insignificance of shadows. He read aloud from his report sheet:

"Michael David George. Age, 47. Freelance technical journalist and author of several books on the subject of the abuse of technology".

Walsh looked-up. "Should be an interesting chase", he said.

"Chase or case"? his colleague enquired.

"Chase, I think, Colby. Mr and Mrs George have vacated their humble dwelling place, it seems".

Walsh's small obsidian eyes were deep-set and not to be defied.

"Let's not fool around, Colby. George is not your average naïve citizen. I want

the Window — just Plymouth to start with".

The operator began calling establishments via his communications terminal.

At the Cross Street intersection, traffic-monitoring television cameras mounted at various high vantage points watched the changing traffic flows. At Municipal Traffic Control, all the key junctions throughout the city could be seen on one flickering bank of monitor screens. A console operator tore off a teletypewriter message and handed it to his superior.

"It's the law again, Bill, they want remote-control patch-through".

Soon, a bank of television screens at the police station sprang to life, repeating all

by Michael Abbott

traffic-monitoring pictures. Walsh had control of their direction. At the busy junctions no-one noticed the sinister sight of lofty cameras swivelling to scan not only the traffic, but the crowds on the sidewalks, too.

British Rail received instructions to hand over control of all its platform and other passenger-monitoring systems, and one department store and supermarket after another allowed the police to see who was shopping on their premises. More banks of television screens at police headquarters lit up to join the shimmering throng.

Walsh had just put down the telephone receiver after requesting Councillor McChesney to the Video Room.

"He'll be here in a few minutes, he's with the Commissioner". Walsh then zoomed in with a supermarket camera to single-out a man waiting at the checkout till. A man with two shopping trollies.

"Colby, isn't that George?"

"Looks like his mug, sir. If he turns round we'll know".

"McChesney will know. This might be him now", said Walsh.

Michael George had moved up the queue. Now with only one person in front of him, he noticed a nearby camera still aimed at him.

"That's George", McChesney said firmly. "You wouldn't think he could kill, to see him standing there with his

shopping, would you"? he queried. "I would", Walsh commented. "There's going to be more of this kind of thing; decent people hitting back". He took the communications microphone.

The woman in front of George insisted on paying for her groceries with cash; it was not a contemporary form of payment and took far too long for George's peace of mind. Two plainclothes policemen entered the store. George knew who they were by their arrogant stroll against the tide of people using the exit. He abandoned his shopping and sidled through the crowd towards the staff exit.

A series of alleyways eventually led him back to the high street where he regained his sense of direction. To return to Sarah's car, he needed first to cross the railway line. His wife would want to know what went wrong, but he had no desire to panic her. In his mind, questions competed for precious thinking time. Would the police have all details of Sarah's car? Of course they would. Might he have only off-line use of his credit card? The police invariably suspended the personal finance of an outlaw.

"We've lost him", Walsh said calmly, "but it's purely ephemeral, isn't it sergeant"? he added, signalling the controller to switch in further closed-circuit monitors.

McChesney pointed to one. "There he is"!

As George crossed the railway, he noticed a remote camera mounted on an adjacent footbridge. It followed his progress over the level crossing, and so he began to run. Dodging bus-queue cameras and the police, he once again found himself disorientated among unfamiliar back streets.

Sarah knew something had gone wrong. Despite instructions to the contrary, she started her car and began to drive round looking for her husband. The car fitted with a radio-telephone, which meant that Michael might ring her and arrange a rendez-vous, so that they could be clear of the city and on their way to Scotland. Her husband had been swallowed up in the poor back streets of the city where not only were all cameras attacked, but frequently outsiders too. Every public telephone booth was a windowless steel cube, vandal-proofed so

(continued on page 71)

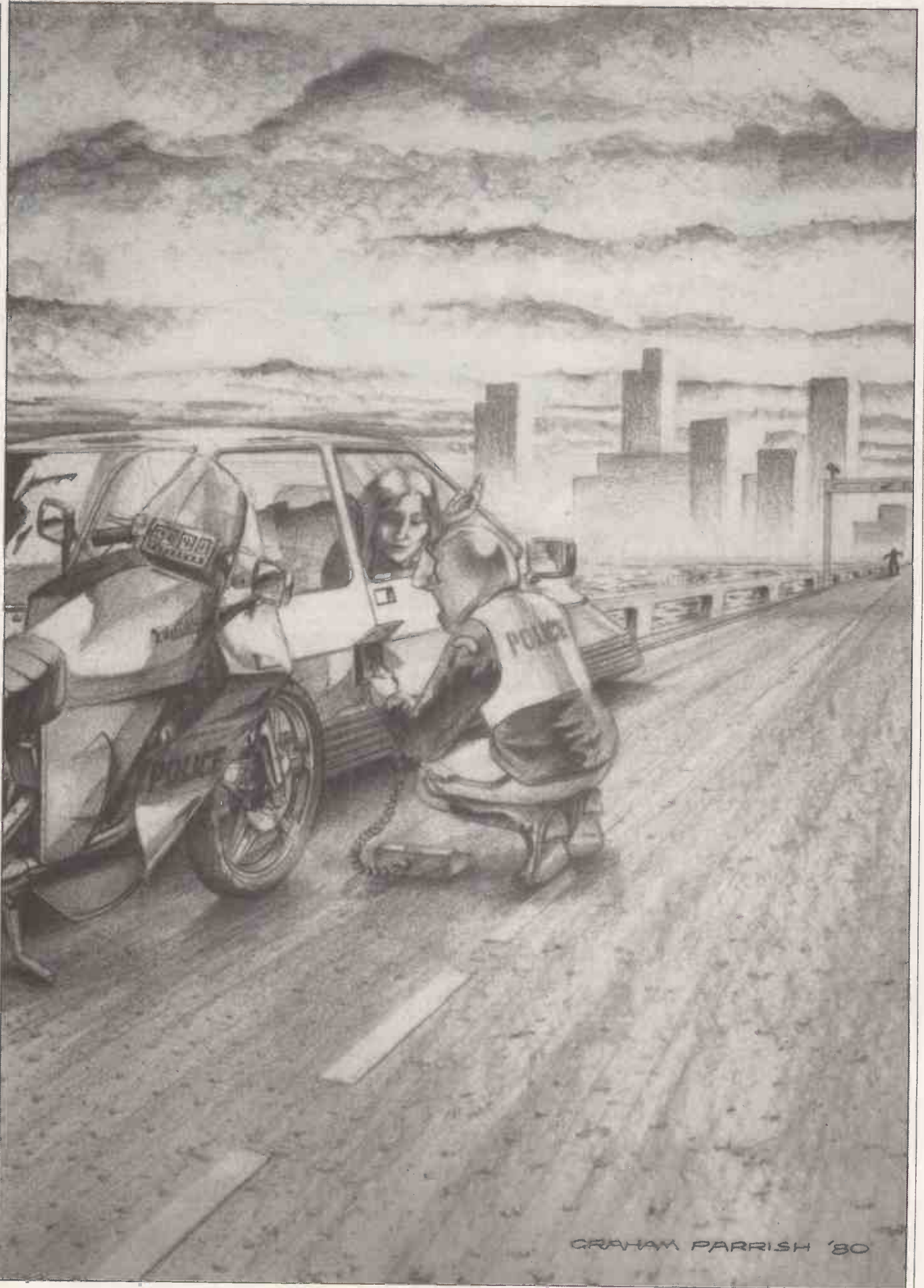

MEET THE FAMILY



... THERE MUST BE ONE HERE FOR YOU

The Exidy family is a sophisticated range of products designed to meet the ever increasing variety of computing needs including home and business uses, educational and laboratory applications, industrial process control, etc.

The Exidy range has been designed with built-in growth capacity to take the risk factor out of computer investment. The Sorcerer Computer now has a memory expansion capability from 8K up to 48K within its own cabinet, enabling the system to grow with your needs plus the ability to add many additional plug-in facilities such as disk drives, printers and pre-programmed ROM PAC's. All Exidy products are backed up by a 12 month warranty covering both parts and labour. The Exidy Sorcerer provides a standard typewriter keyboard plus a 16 key numeric pad. Connections are provided for future expansion within the keyboard unit.

If you want an accounting machine, a word processor, or a program development system, the SORCERER offers all of these within the same unit.

The Word Processing ROM PAC allows you to create, edit, re-arrange and format text. The operator's work is displayed clearly on a screen—you can see the whole of an average business letter—correct mistakes—re-arrange it. Once perfected—press a key and the printer will type a perfect letter in record time—as many times as you like—no wasted letterheadings. Features include auto wraparound, dynamic cursor control, variable line length, global search and replace, holding buffer for re-arrangement of text, right justification, line width and line to line spacing, underlining or boldfacing, text merging and a macro-facility permitting tasks such as formletter typing, multiple column printing or automatic forms entry.

Now contact your nearest dealer:

The NORTH

BASIC COMPUTING, Oakville, Oakworth Road, Keighley, W. Yorkshire. 0535 65094
E.S. MICROCOMPUTERS, 7 Berkeley Prec., Ecclesall Road, Sheffield S11 8PN. 0742 668767
GLYSTHYDON LTD., Nook Farm, Rake Lane, Warton, Preston, Lancs. 0772 633138
MAGNUM CONSULTANTS, 57 Fairburn Drive, Garforth, Leeds. 0532 867892
MICROPUTE, 7 Westbourne Grove, Manchester M20 8JA. 0625 612818
MICRODIGITAL, 25 Bruswick Street, Liverpool L2 0BJ. 051 227 2535
TW COMPUTERS LTD., 293 London Road, Hazel Grove, Stockport. 061 456 8187

MIDLANDS

M&R SYSTEMS, 20 Norwich Road, Wisbech, Cambs. 0945 5900
MIDLAND MICROS, 1 Cherry Wood Drive, Aspley, Nottingham. 0602 298 281
GRIFFIN & GEORGE, Birmingham, Manchester, London, Eastkilbride. 01 997 3344

LONDON and SOUTH EAST

E.M.G. MICROCOMPUTERS, 30 Heathfield Road, Croydon, Surrey CR0 1EU. 01 688 0088
HOME & BUSINESS COMPUTERS, 445 High Street North, Manor Park, London E12. 01 472 5107

MICROBITS, 34b London Road, Blackwater, Camberley, Surrey. 0276 34044
SLOUGH MICROSHOP, 120 High Street, Slough, Berks. 0753 22855
TVJ MICROCOMPUTERS, 165 London Road, Camberley, Surrey GU15 3JS. 0276 62506
C.C.S. MICROSALES, 7 The Arcase, Letchworth, Herts. N2 9EN. 046 26 73301
G.P.W. ELECTRONICS, 146a London Road, North End, Portsmouth, Hants. PO2 9DJ. 0705 693341

INFORMEX-LONDON LTD., 8-12 Lee High Road, London SE13. 01 318 4213
NIC, 61 Broad Lane, Tottenham, London N15. 01-808 0377

WALES and the WEST

TRYFAN COMPUTERS, 3 Swifts Blds, High Street, Bangor, Gwynedd LL57 1UW. 0248 52042
ELECTROPRINT, 5 Kingsdown Parade, Bristol BS6 5UD. 0272 292375
LIVEPORT DATA PRODUCTS, The Ivory Works, St. Ives, Cornwall. 0736 798157
TVJ MICROCOMPUTERS, 48 Gloucester Road, Bristol BS7 8BH. 0272 422061

Or send coupon for further information to:

SOLE DISTRIBUTORS

Geoff Wilkinson
LIVEPORT DATA PRODUCTS
The Ivory Works, St. Ives, Cornwall.

PLEASE SEND DETAILS OF THE EXIDY RANGE

NAME _____

ADDRESS _____

PC7

• Circle No. 163

(continued from page 68)

that only paid-up 'Phonekey' holders could gain entry. Alert to the hazardous environment, George moved briskly along to a riverside park.

Councillor McChesney wanted to know what Superintendent Walsh intended to do.

"You've lost him", the councillor said. "I hope you didn't want him to escape".

Walsh aimed his narrow eyes at McChesney like a double-barrelled gun.

"If you can fault my thoroughness, you do so. I intend to do everything I can to bring George in, but if that's not enough, then good luck to them both. Men on the run with their wives is something new to me, Councillor. If I had my way I would employ police resources elsewhere, like investigating municipal corruption."

"What is that supposed to mean, Walsh?" retorted the councillor. "George is a murderer. He killed a colleague of mine in cold blood".

"Suspected of", Walsh interrupted. "A jury will decide, not you. Anyway, this city might be a happier place without Councillor Skinner". He switched his focus from McChesney back to the video bank, and wondered if he had said too much.

"Consider yourself on record as having said that, Superintendent Walsh".

Sarah thought she could see Michael on the opposite riverbank. She accelerated along Bridge Approach in her powerful hybrid car, but this behaviour attracted the attention of a police motorcyclist, who flagged her down halfway over the bridge. She told the constable her driving licence was at home, and as he booked her for speeding, the man who looked like her husband disappeared into the distance.

The officer opened a flap in the side of her car.

"Look, officer", Sarah said nervously, "there's no need for evidence from that thing, I plead guilty. I'm in a desperate hurry".

"It's your hurry that concerns me, lady".

The constable found the black box recorder. Fitted to all private vehicles by law, and originally conceived to provide crucial data about serious accidents, the microprocessor-based device now served primarily as an indisputable back-up for police prosecutions.

The figure on the esplanade had encountered the distant profile of a police patrol car and about-turned, drawing closer again. Sarah verged on panic, for the policeman held a digital read-out unit which he connected via an umbilical cable to the black box. Michael had previously switched number-plates on the car to fool the police, and unfortunately, the first thing to be displayed would be the correct vehicle registration.

Recognising his wife on the bridge, Michael George appreciated what was happening and raced up the stairs to the roadside about 100m. away. He then stood there idly until a car drove up and leapt in front of it.

With perspiration blurring his vision, he threw himself towards another vehicle approaching in the opposite direction. The objective was to cause a shunt — and it worked. Tyres screamed and two cars collided with a thud of tinkling glass. He then slipped out of sight down the subway stairs to the other side of the road.

The police officer looked up and shut the recorder housing flap.

"You'll receive a summons", he told Sarah, and left.

She jumped into her car and slammed the door. The passenger door slammed simultaneously as Michael joined her.

"God, where did you spring from?" she asked.

"Never mind. Just get going".

On the road

Michael told Sarah to drive to a car-hire company on the outskirts of town, and quizzed her about their regulations, knowing that she had hired from them herself.

"On the weekend rate", he asked, "didn't you say you had to return the car before their office opened in the morning"?

Sarah confirmed this: "That's right. There was no need for me to go inside because they made up the bill to my credit card number. They told me to leave the car around the corner with ignition key in".

"Good". Said Michael, "then we can fit ourselves up with a nondescript car. Our future may depend on it".

Indeed, there were two unattended cars outside the hire office before opening time.

"A Lee Electric 160C", he said, "that's good because there's more of those on the road than any other car. You stay in this one Sarah and follow me".

Soon they pulled up outside the local newspaper offices. Michael ran back to Sarah's car, asking her to telephone the hire company. He took the receiver.

"Hello, I'm the chap who hired your white 160C, registration DUK 6145E. I should like to extend the hire period by another 48 hours, if I may. It was due in this morning".

"I'll just look into it sir, can you give me your name please?" a girl replied.

Michael was prepared for this difficulty and interrupted her.

"Hello, hello, can you hear me"?' he shouted repeatedly, winking to Sarah. He behaved as though they had been cut off, and then, speaking loud enough to make sure the hire girl overheard, he said:

"I think I've been cut off. I'll have to ring back".

The girl at the company called out to her assistant, "Who's got the white 160C"?

"Mr Dankworth", was the reply.

When Michael rang back, he said apologetically:

"I'm sorry, I got cut off just now. Is that the same person I spoke to"?

"Ah, that must be Mr Dankworth again", she replied. "It is alright to keep the car for another 48 hours — I checked".

Michael replaced the receiver.

"We now have a car totally unconnected with us", he told Sarah, "and which, unlike a stolen car, will not be reported missing for at least 48 hours".

Sarah followed Michael into the newspaper office, unsure whether or not to admire her husband's cunning. It was one of the most technologically-advanced provincial newspapers in the country. Classified advertisement copy could be dictated direct on to a video compositor, and be seen in print in as little as ten minutes. Laser-etched litho plates could be transposed automatically from an idler roller without stopping the press.

Michael inserted a request for a courier to drive Sarah's 'Hybrid Assailant' from Plymouth to an address in Brighton.

Sarah pulled her husband to one side.

"I can see the point in us taking off in that car out there, but why do we need to send my car to Brighton? We don't know anybody at the address you gave".

"No, but the police might expect us to travel that way, since I have a brother near Brighton. They'll be watching all possible bolt-holes".

Sarah's pretty face reflected the fact that she was some fifteen years younger than Michael, and also that she was bemused.

"I'll explain everything once we're on the road, but right now we have to hang around here until the advertisement appears".

Michael had arranged with the desk clerk to allow replies to his advertisement be taken on the copy-desk telephone in the waiting room.

"Why can't you tell me what you are up to now, Michael"?' Sarah asked.

"Because we are not alone, and because it will take time to make you understand. The police have the means to watch us all the time, and I'm not talking about those street cameras either".

The decoy

Within an hour the telephone rang. After some discussion, the applicant wanted to know how and when he would receive payment.

"It's not that I don't trust you, Mr George, it's just that I don't know you, if you see what I mean? I do a lot of this casual work and I've been caught out before now".

"I've got your details", said Michael.

(continued on page 73)

(continued from page 71)

"I'll arrange for a credit transfer at my Brighton bank branch. It's quite near the delivery address. After that, I'll drop the car in to you".

He was in no position to make any such payment available, for he knew the police would have a real-time monitor on his bank account.

Michael drove the Assailant to the courier's home while Sarah parked the 160C around the corner.

"Nice car", said the young man.

"Sure", Michael responded. "Feel free to open her up on the motorway, she really flies. Very rewarding to drive".

"About the main part of my reward"? he asked.

Michael needed to bluff convincingly.

"It's not that I don't trust you, Mr Gates, it's just that I don't know you, if you see what I mean"?

They both laughed before Michael continued.

"So I've arranged for your credit pick-up at this bank". He handed over a piece of paper.

"This way I shouldn't have to worry about you taking payment and then dropping my wife's car. The manager will require the ignition keys before authorising payment; he's a friend of mine, you see. I'm sorry to be like this, but I've used casuals before and I, too, have been caught out".

"That's OK", said the young man. Michael leaned in through the Assailant's window and lifted the radio-telephone receiver.

"Now, if you have any doubts you can ring the bank manager for confirmation".

Mr Gates emitted an uncomfortable cough and declined the offer.

The 160C made far less progress on such a long journey than Sarah's car would have done, but at least they could share the road with motorway police uneventfully.

Sarah switched off the radio and insisted on an explanation for all the skull-duggery.

"Your car will not affect things unless the weather clears up", he told her. This was no help at all.

"I don't see how it acts as a decoy", she said. "The police will spot my car, pull it over and find out what you've done; then they'll know we're using a different car. Why could we not simply have left it down a side street"?

"We need petrol", he said abruptly. "We shall be running on batteries only".

Sarah's bewilderment increased as they sped past the filling station which had obviously been the reminder about petrol in the first place. The car left the motorway by the next slip road, near Carlisle.

"We need a backwater station where the pumps take off-line payment. Otherwise, when the vending machine interrogates my account to see if I've got enough

to pay, the Plymouth police will know exactly where we are. The road-blocks would be up before we left the garage. If we're really lucky, we might find somewhere that takes cash without suspicion".

"If we have to use your card, darling, how will you know if it's on-line or not"? Sarah enquired.

"I know one little trick that works. Enter the card upside down. If the machine says 'CARD EXPIRED' it's off-line; if it says 'CARD INSERTION ERROR' it's the on-line type".

Walsh turned to Inspector Colby who had just reported Michael George's abandoned car in a multi-storey car-park.

"I've been stupid. I had all units looking for George's car, without giving a thought to his wife's. Alert all units to a blue Assailant and give the registration details".

He relaxed his vigilance of the video monitors, and looked hard at Colby. Colby replaced the telephone receiver, and retorted: "Everyone's on our backs to return control of these closed-circuit televisions now, sir".

Walsh broke his gaze with a frightening jump.

"Do it. We've missed the boat; they'll be out of town by now".

"Things may not be so black, Super", Colby said, and handed Walsh a weather report. "It should be clearing up in the next few hours. We might be able to squeeze in some satellite time before nightfall".

Re-fuelled, and back on the motorway, Sarah sighed with relief as they crossed the border into Scotland.

"Now," she said, "you were telling me about our decoy".

"The police, my sweetheart, have a geo-stationary satellite over our heads, just waiting for those clouds to go away".

Sarah looked concerned.

"I did tell you about it. If you remember, I wrote an article on the thing for the technical press. The law use it to watch Britain's roads, among other things. That satellite can observe traffic congestion, the progress of abominable loads, and under certain conditions, the movement of individual vehicles on the open road; so long as the vehicle concerned is reasonably distinguishable".

"Surely it can't see much from that height"? Sarah asked.

"On a clear day, the on-board optical equipment would be able to see the newspaper headlines right over your shoulder".

Sarah squinted at the clouds.

"Not a good thing it's cloudy, then", she said. "Our decoy wouldn't have had any effect, but I can't believe they use that thing to spy on people anyway".

"Officially they don't use it that way; only for forest fires and road problems, but I do not believe the police would resist the temptation to use it in a chase".

"My God, to think that thing could see us in the garden last summer; you really should have told me", Sarah said in horror.

"So you see darling", Michael continued on his own train of thought, "even on a brilliant day we could never be singled out from all the other white 160Cs on the road. A blue Assailant moving fast down the motorway, however, is another matter".

"Like our friend Mr Gates", Sarah added.

"The crafty swine" Superintendent Walsh said in a soft, behumbled voice. The Portsmouth police had intercepted Gates in Sarah's car.

"He knows all about us, doesn't he Colby? He could have fixed up that Brighton decoy remotely, and much more quickly using teletext, but he went to a local newspaper. He knows how we've got things wired".

"Do you think we'll catch him"? Colby asked.

After a thoughtful pause, Walsh said with a jolt:

"What kind of a question is that? We'll need the satellite, though, this guy is a technician".

He reflected on something which Colby once said, that the police would be lost without the sat'. This observation haunted him. It seemed to be true. He spoke again with optimism.

"We may not get the necessary clearance, Colby, the Commissioner doesn't like it. Political terrorists yes, but common criminals, that contraption's too busy. We may have to rely on good old-fashioned techniques".

Colby handed Walsh a copy of a magazine article.

"The Commissioner should read this, then. It's by our friend George and it features the sat'. What he doesn't actually know, he guesses with disturbing accuracy".

"So", Walsh pondered, "the Brighton decoy was meant for what George calls the eye in the sky, not a patrol car. I would bet your life on something Colby".

"Thank-you, sir. What"?

"George will have nicked a two-a-penny car, the best place to hide, after all, is in a crowd".

Colby's face cockled.

"So we're looking for a Ford Obus or a 160C".

"Maybe a Talisman", added Walsh. "If any of these models has been knocked off in the Plymouth area in the last 24

(continued on next page)

This was one region the satellite seldom saw.

(continued from previous page)
hours, I want all the details”.

Colby retreated to a keyboard.

“Oh, and Colby”, Walsh shouted, “Any of those models hired as well”.

The 160C wound its way high into the misty prehistoric-looking mountains of the western Highlands, where heavy, bruised clouds took no heed of the general weather forecast. This was one region the satellite seldom saw.

Head against the glass, Sarah awoke from a doze.

“I hope this friend of yours is ready to sail. I take it he knows you could face the death penalty”?

“No sweetheart, but he’s reliable, he’s a friend of old; primary school in fact. It’s a friendship formed too early to source on the National Records Computer with any luck. We haven’t seen each other since I was a bachelor”.

With details of stolen cars, Colby made enquiries at the newspaper office where Michael George placed his advertisement. On his return he found Walsh back in the computer room staring mawkishly at a blank VDU.

“I think I’ve unearthed something, sir”, Colby said. “A white 160C was seen outside the newspaper office at the time George placed his ad. A clerk took the telephone number from the hire sticker in its rear window”.

“A hired car then”? Walsh said. “Did you follow it up”?

“I did sir, and a most peculiar thing happened”. Colby went on to explain the trick played on the car hire company.

“It must have been our man”, Walsh ventured. “I would expect something more refined than a straight car-theft from George”.

Colby pressed some buttons, and a map of the U.K. appeared on a large wall screen.

“It was taken with a full tank, Super, so, if his journey was long enough to require re-fuelling at all, and assuming he wouldn’t stop for petrol until it became necessary to minimise the risk of us picking him up, I think it might be worthwhile checking the petrol stations in this area”.

A coloured band appeared across the map, stretching from Carlisle to just south of Newcastle-upon-Tyne.

“That’s how far a full tank would take him is it? It’s all tenuous though, Colby, they might stay south”.

“Might do, sir, but it’s worth checking. I would make for remote parts if it was me”.

“If he knows about the sat’, he won’t attempt flying out of the country, but he may well use a private boat”.

Walsh thought carefully.

“I’m damn’ sure he’ll take his wife and himself out of the U.K. He could resume his attack on our so-called police state from some Third-world country with total freedom, but he doesn’t have a boat of his

own, does he”? He was thinking aloud. Walsh took a seat at the console.

“Friends”, he muttered. “Friends with boats”. He looked up at Colby’s questioning face. “Go on then, check the filling stations in that suspect area of yours”.

“Yes sir. I’ll have to go up there personally to check through the off-line stations”.

McChesney entered the room as Colby left. After some minutes looking over Walsh’s shoulder, the word ‘SEARCHING’ came up on the screen.

“What’s that”? McChesney asked.

“I’m conducting a data-string search”, was the reply. “The National Records computer is going to furnish me with every possible friend of George’s. It’ll create a list of everyone George ever worked with or went to school with, going right back to kindergarten. When it’s done that, it will refer to the temporary data store to extract more information.

This time it’ll create a file of all boat-owners who at present have deep-draughted vessels registered as docked at any sea-access mooring in the country. When it’s done that”, he continued with mock fatigue, “the machine will compare every person in the first file to every person in the second, and if any one person is in both, it could be bingo”.

“We could do with one of these gadgets”, McChesney snorted.

Man on the quay

Against a background of choppy grey water, the Georges’ car pulled into the quay car park at Fort William, where Michael’s friend, Andrew Bell, awaited them anxiously. They were beckoned aboard his luxury cruiser, stopping briefly for introductions, for Andrew had never met Sarah.

“You’re lucky I happen to be back in this part of the world, Mike”, Andrew rasped, his Highland accent alive and well. They went below to discuss their journey and the visibility forecast. It seemed they could be well clear of the mainland before emerging from cloud cover.

“We’re to cast-off soon”, Andrew told them. “We can be away faster with the powerful tides in these lochs on our side”.

When Walsh learned of Michael George’s stop at a service station near Carlisle, as far as he was concerned the detective work was complete, for the name Andrew F Bell glowed in soft fluorescent green on the VDU before him. Details of his boat, and its present mooring, accompanied Bell’s name. Walsh arranged to fly to Scotland immediately.

The cruiser’s roof roared with the driving rain, almost drowning its occupants’ voices. With Sarah in the galley helping Andrew’s shipmate, an attractive Jamaican girl, Andrew’s eyes

began to twinkle with curiosity. Without actually sporting a beard, he was as near to a traditional rugged Highlander as one could get. He glanced upward.

“This’ll keep that satellite of yours minding its own business”.

He then leaned forward confidentially.

“Am I allowed to ask what it is you’ve done Mike”?

Michael began to explain. He described his 200 acres of untouched Devonshire countryside, with his custom-built house at the centre. It had taken everything to secure the land.

“I did it to stop the rolling barrage of housing” he said. “The builders, who incidentally comprise most of the local council, are turning Devon into one big housing estate, like they did to Dorset. I had an animal sanctuary on my hands. All the wildlife of the area was being driven into it. It’s a great pity you never saw my place Andy, it was quite something”.

“You say ‘was’, Mike”?

“They finally hit me with a compulsory purchase. I received less than market value, and now, my house is in the middle of a red-brick jungle. Any land not yet built on is cluttered with dumped cars and screaming kids”.

“It’s a good thing you’re out of the country Mike. Buy yourself a boat. My garden is anywhere in the world almost”, Andy commented.

“That’s not why I’m leaving Andy, I killed someone. Councillor Skinner. He was the prime mover behind it all, and when things got really rough, he offered to ease up, but the conditions were an insult to my wife. I don’t want to go into any more detail than that, Andy”.

Andy nodded. “I would have killed him myself”.

“He made the offer while I was there”, Michael continued. “I just lost control and struck him. I should have bottled it, he was just being antagonistic because he envied me my wife, but unlike everything else, he couldn’t take her away from me”.

Andrew put his hand on Michael’s shoulder.

A stranger on the quay assisted Andrew in casting off in the evening twilight. As he waved goodbye, the helper spoke.

“Did I see Michael George on board”? Andrew raised an eyebrow but said nothing.

“I’m a fan of his”, the helper said. “Read most of his work on the abuse of technology”.

The cruiser throbbed softly into the darkness as the stranger stood close to the edge and shouted one last message.

“Tell Mr George not to worry, I did it without the satellite. Tell him we can call it a draw”.

The stranger entered a telephone booth and made a call.

“Colby”? he said, “Walsh here. We hooked a red herring, I’m afraid. I’m coming back on the next flight”.

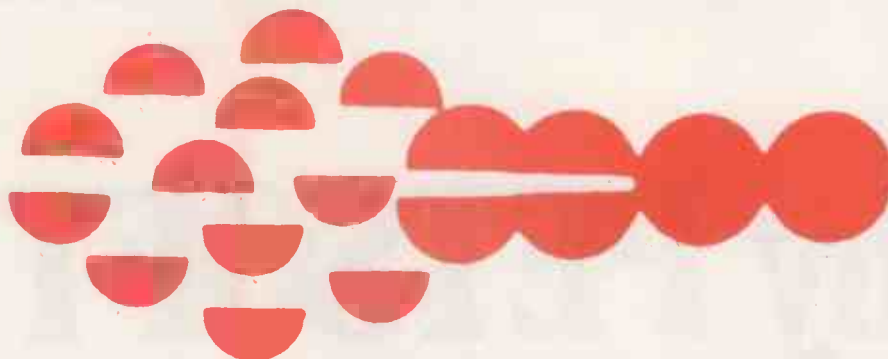

SYSTEMATICS INTERNATIONAL LIMITED

Europe's leading Publishers and Distributors of
Software for the Apple II and ITT Microcomputer

PROUDLY ANNOUNCE OUR MICRO SOFTWARE CATALOGUE Edition II

A Library of over sixty professional Programs for
Business, Education, Personal

*For your free copy of the
Catalogue contact:*

**Systematics International Ltd.
Microsoftware Division,
Essex House,
Cherrydown,
Basildon, Essex
Tel: 0268-284601
Tlx. 99431**



A few of the new Programs featured are: Text File Library, Easy Writer, Easy Mover, Payroll, Rental Accounting, Database, Property Management, Inter-Stat, Touch Writer, Better Mail, Sargon II.



Why PETSOF Business Softw

WORDCRAFT

WORDCRAFT A true Word Processor for the 32K PET. Wordcraft is a genuine word processing system, easy to understand and use, but containing all the facilities normally found only on more expensive dedicated Word Processors. Features include scrolling in both vertical and horizontal directions (to overcome small screen size), up to 117 characters wide and 98 lines deep for a full page of text. Written entirely in machine code for speed and compactness. Truly the Rolls-Royce of PET Word Processors. Send for brochure. £325 on CompuThink or Commodore Disk.

ACT SALES LEDGER

ACT SALES LEDGER A powerful system developed to ACT's own high standards. Provides full facilities for maintenance of the Sales Ledger, preparation of a list of outstanding balances and printing of statements. All data including new customer details, invoices, credits, cash and transfers are entered under step by step guidance on the display screen. Printed results include Audit List, Aged Debtors List, Control Accounts and Statements. For 32K PETS. Full manual supplied. Brochure available on request. £120 on Commodore Disk. £95 on Cassette.

STOCK CONTROL

STOCK CONTROL Powerful and flexible stock system with full facilities for recording and control of stock information. An audit listing is automatically printed which itemises all transactions including the entry amendment and deletion of master stock information, issues receipts, allocations, purchase orders. Printed reports include Full Stock Control, Stock Valuation, Reordering Report, Audit Listing. The system is highly flexible.

£50 on CompuThink or Commodore Disk.

ACT PURCHASE LEDGER

ACT PURCHASE LEDGER £120 Developed by ACT's own software teams this comprehensive package includes full facilities for the maintenance of the Purchase Ledger, the preparation of a list of outstanding balances and printing of remittance advices. The system produces the following printed results: Audit List, Aged Creditors List, Control Accounts, Purchase Ledger Record, Remittance Advice Cheques and Payments List. For 32K PETS. Full manual supplied. Brochure available on request. £120 on Commodore Disk. £95 on Cassette.

PAYROLL 200

PAYROLL 200 Comprehensive, easy-to-use package for small businesses with up to 200 employees. Facilities provided include Holiday Pay, Sick Pay, Bonus Payments and two rates of overtime, as well as allowing a 'Standard week' to be specified for each employee. Weekly and monthly summaries are provided and amendments necessary because of a Budget are made very easy. Prints wage slip and coin/note analysis. Tax & NI are computed automatically from knowledge of employees codes. Update service available. Full manual provided. £50 on Commodore or CompuThink Disk. Cassette system also available at £25

PETPLAN BUSINESS SIMULATION

PETPLAN BUSINESS SIMULATION Petplan is a general management business simulation game which is exciting to play. Already it is widely used by colleges and Industrial Trainers to teach the skills needed to run a business. The program creates the model of a manufacturing company; you take the decisions. You will need to hire workers, invest in plant and premises, set advertising budgets and prices. At each stage screen reports (which may be printed out) show the results of decisions as they take effect. 50 page manual and voice guide on cassette. For 32K PETS. £60 on Cassette.



are No.1 in...

are for the PET

VISICALC PROBLEM SOLVING SOFTWARE

VISICALC PROBLEM SOLVING SOFTWARE Acclaimed by the press as the most outstanding piece of PET software yet written, VisiCalc is a new breed of problem solving software that takes the hard work out of planning, projections and costings. Once your first projection is complete, you are ready to use the powerful recalculation feature. It lets you ask 'What if', examining new options and planning for contingencies. What if sales drop 20% in October? Just type in the sales figures and VisiCalc instantly updates all other figures affected by October sales. Invaluable to businessmen and students alike. Full manual supplied. Available late June. £125 on Commodore Disk.



Petsoft sell more programs in Britain than anyone else, for two simple reasons:

Quality and Value!

You will find Petsoft programs on sale in more than 200 computer shops throughout the country, and in many more all over the world. We invite you to try them.

If you can't find the program you need, contact us directly. We offer over 200 titles and can supply you directly. We will even take credit card orders over the telephone. Since we normally carry all programs in stock, you won't have long to wait.

Petsoft is backed by the resources of Applied Computer Techniques Ltd., Britain's leading computing group. With over fifteen years experience of developing business software, ACT has a reputation second to none in the industry. That is your guarantee.

If you would like more information on any of the programs mentioned on these pages, clip out the coupon. We will see that a free copy of our complete PET software catalogue reaches you without delay.

PET is the trademark of Commodore.

Plus

Some other PETSOF T products described in our catalogue:

Programmers Toolkit £55

Plug-in ROM Chip adds nine useful commands to PET BASIC including RENUMBER, TRACE, DUMP, FIND and APPEND.

Talking Calculator £10

Calculator program with synthetic speech via user port sound generator.

Micro Pools Package £20

A scientific approach to winning the Football Pools, on cassette.

6502 Assembler Tutorial £25

How to program in 6502 Assembly language. On CompuThink or Commodore Disk.

Presto Digitizer £42

Electronic tablet accepts handwritten input for the PET.

User Port Sound Generator £27

for Talking Calculator program, electronic music etc. With volume control.

76 Common Basic Programs £15

Adam Osborne & Associates classic collection of financial and mathematical programs on cassette.

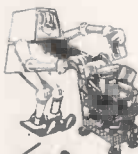

Raddlyffe House, 66-68 Hagley Road
Edgbaston, Birmingham B16 8PF
Tel: 021-455 8585 Telex: 339396 ACTINET

Prices exclude VAT and were correct at time of going to press.

ACT Petsoft

Please rush a FREE copy of the latest Petsoft catalogue to:

Name:

Address:

Postcode:

I have an 8K PET
 16K PET
 32K PET
 No PET yet

Low Cost Professional Systems

SHARP MZ80K

SUPER DISCOUNT PRICES FROM H.B.

Model	User Ram*	Our Price £
20K	6K	462.00
24K	10K	485.00
32K	18K	520.00
30K	22K	550.00
48K	34K	599.00



COMMODORE PET

THE FASTEST SELLING MICRO IN THE U.K. SURELY NEEDS NO INTRODUCTION. FULLY SUPPORTED BY HIGH QUALITY APPLICATION SOFTWARE INCLUDING INCOMPLETE RECORDS, PAYROLL, STOCK CONTROL AND THE RENOWNED H.B. SALES, PURCHASE AND NOMINAL LEDGER PACKAGES. SYSTEMS FROM £2,500.00.



ACT 800/824

COMPLETE WITH NEBULA SOFTWARE FROM THE A.C.T. STABLE, THIS VERY EFFICIENT SYSTEM IS SUITABLE FOR LARGER APPLICATIONS AND ADMIRABLY TAKES OVER WHERE CBM STOPS. HARDWARE FROM £3,950.00. COMPLETE SYSTEMS FROM £7,450.00.



BASF

NEW TO THE MARKET BUT WITH ALL THE QUALITY, RELIABILITY AND SOPHISTICATION YOU WOULD EXPECT FROM THIS INTERNATIONAL NAME. VERY EXTENDED 19K BUSINESS BASIC, INTEGRAL DISKS AND MANY OTHER FEATURES NOT NORMAL ON SYSTEMS COSTING SO LITTLE. FROM £4,275.00.



WE ALSO STOCK PRINTERS, DISKS, INTERFACES, MEDIA, CONSUMABLES, ETC. EVERYTHING TO CONVINCE YOU THAT H.B. SHOULD BE YOUR SINGLE SOURCE FOR COMPUTER PURCHASES.

SEE US ON STANDS 2-8 AT THE MICRO COMPUTER SHOW

THE END OF YOUR BUSINESS ADMINISTRATION PROBLEMS COULD START HERE.

H.B. COMPUTERS LTD

22 NEWLAND STREET, KETTERING, NORTHANTS.

Telephone (0536) 83922/520910

Telex 341297



• Circle No. 167

Contemporary look at a new technology

PRESTEL HAS already made its public debut to a fanfare of publicity which included advertisements in the major daily and business papers. It is now available as a public service — strongly aimed at the business user — and it is confidently predicted that by the end of the year 50,000 sets will be in operation.

The vast majority of these will be dumb terminals — TV sets with a Prestel interface, intended to supply the user with on-line information. The next development, as argued by Peter Sommer — *Practical Computing*, May, 1980 — is likely to be the introduction of the intelligent terminal which will not only store pages in its memory — making for more relaxed viewing, particularly for the domestic user who has to pay for his telephone-line time without the possibility of setting it against tax — but also have the possibility of storing programs for future use.

Huge stride

Down-loading telesoftware, as the buzzword describes it, is clearly a huge stride into the future for the microcomputer enthusiast. It is likely to cut costs of software enormously and makes instant, error-free programs a reality. It also brings the physical transmission of programs into line with the modern world.

What could be more antiquated than copying a program on to disc, then packing and mailing the disc through the Post Office? It doesn't make sense, and the instant relevance of down-loading telesoftware has already been demonstrated to us by the phenomenal number of accesses to the *Practical Computing* page of Apple software — available on Prestel page number 45631.

Yet for the public, all that seems a little esoteric. Unhappily, the computer still invokes the image of a semi-human hunk of machinery which can be handled only by a highly-trained and super-skilful technological priesthood.

Greater potential

Those fears will doubtless disappear as the generation of computer-wise adolescents comes of age, along with the technology at a reasonable price in every home, but for the present the TV screen is the only familiar reality. That is why the proponents of broadcast teletext feel that their system has more potential in the home than Prestel.

Ideally the broadcast and land-line Videotex systems should be compatible and complementary, although as we shall see, there are some problems to overcome. The major advantage of broadcasting software is that it provides the

possibility of intelligence at the terminal without the need for the user to tackle a new 'tool'.

All he needs is the TV receiver — the processor in production models will, of course, be in the box rather than as an add-on-module — and the existing remote numeric keypad. For many of the computing operations which people are likely to wish to perform in the home, numeric will suffice, though there is, of course, no reason why an alpha-numeric keyboard should not be used for more complex operations.

The applications envisaged for broadcast software include assessment

by Martin Hayman

programs for items such as tax and mortgage payments and possibly social security benefits. The advantage claimed for that kind of calculation is complete privacy. Obviously any data, personal or otherwise, which you are inputting can go no further than the set with which you are working. Other forms of calculation would include complex but specific routines such as assessing the most efficient form of central heating in a home.

Education is an area which is already receiving attention within Oracle. It is claimed to be especially suitable for telesoftware implementation and the Department of Industry has already funded a project to be run under the supervision of the Brighton Polytechnic department of computing to the tune of £15,000. ITV and BBC are both involved in the project which will put 10 Mullard telesoftware receivers into schools around the country.

It is also regarded as something of a pilot study to check what kind of language would best suit telesoftware. One point John Hedger of Oracle makes is that the choice of Basic for the Brighton project, though by no means definitive, is certainly not arbitrary. Brighton is seen as a field trial, a way of evaluating possibilities rather than a definitive implementation. That is currently rather a ticklish point since a great deal hangs on the outcome.

It is clearly desirable that teletext and Prestel should be compatible, and programs machine-independent, but there are several systems in use throughout the world and there are obviously large commercial interests at stake. France, Japan and Canada are all interested in telesoftware although U.K. exponents claim still to have the most hands-on experience.

The second major problem which the broadcasting authorities face, and more

specifically ITV, is that of making a profit. ITV would not be behind such a large investment project if they did not believe there was a commercial future, and Hedger told me that the whole operation was market-driven. Yet one wonders if this is a case of optimistic thinking.

Popular games

In Hedger's demonstration at Viewdata 80, the brief mortgage calculation program was provided by the Nationwide Building Society, which would clearly be expected to pay for the privilege of using its name. Would the same, for example, apply to that most popular sector of Prestel — games? More likely the providers would do everything in their power to inhibit such developments.

Who is going to bother with buying a video game if you can down-load and copy a new game every evening perfectly legally, if the system operates in the same way as the MCPS-authorized licence for copying gramophone records? For this reason ITV has every reason to hope for the possibility of obtaining a licence for paid-up advertisements.

Where does all that leave the micro-computer manufacturers? Some, like Technologies and Hi-Tech, have already made a rapid entry into the market, but as Hedger says: "They are not going to stand by idly and watch telesoftware take over".

Plug-in options

He foresees plug-in telesoftware options — bluntly, an aerial socket as a data grabber. Why bother to patch in updates on financial programs when you have the thing debugged and ready-to-run by simply adding an aerial?

Of course, where broadcast telesoftware and the intelligent TV loses is in the interactive possibilities of landlines. To Hedger's mind that means that the two can usefully dovetail. He envisages for example, a colour advertisement on the box, with surf and palm trees, for an exotic holiday.

The advertisement gives a teletext reference to the travel agent and you look it up, maybe with a short routine to find the time and price which best suits the enquirer. Once he has found the holiday in that location which corresponds to his means and his free time, he makes his reservation and pays the advance money by credit transfer on Prestel which itself is shielded from a deluge of enquiries by the buffer effect of the teletext enquiry procedure. All this, without moving from your armchair.



Supertank

A blow-by-blow account of the writing and playing of a battle game.

THE WAR had not lasted long. The computers had seen to that. Salvoes of missiles had crossed the sky in almost ritualistic fashion; counter-measure had opposed counter-measure until the ultimate weapon had breached the enemy's defence and wiped-out his nerve centre.

A strange hush settled on a scarred landscape and the victors emerged from their shelters. The celebrations were short-lived, however, since something else was also emerging — the final retaliation.

From an artificial cavern deep in a mountain, safe from the prying eyes of the spy satellites, rumbled the monster tank. As it rolled across the devastated plains towards the home territory of the victors, a frantic intelligence-gathering exercise sought-out its dread secrets. When they were revealed, they brought little comfort.

Nuclear device

The tank carried a nuclear device of hitherto-unrealised power. It would be detonated when the tank reached a secret destination, deep in the heart of the land, selected by the on-board computer which controlled all the functions of the mighty tank.

Supertank, for such it had been nicknamed, was driven inexorably forward by hundreds of nuclear-powered engines, and only deviated from its chosen path to avoid one of the many deep craters left by the war.

Nor was it defenceless — hundreds of missile launchers bristled from its outer hull and would be brought to bear against any hostile force the computer detected.

The only way to prevent this final tragedy of a tragic war was to stop Supertank — not only stop it, but destroy it utterly, since the computer was programmed to detonate the bomb if it sensed that all opposition has been destroyed.

Desperately, the defenders assessed the meagre resources left to them. Only a

by Bob Merry

handful of missile sites were still operational and added to these was the remnants of one missile tank squadron. These mobiles, as they were known, were pathetically small and weak compared with Supertank, but they were more manoeuvrable; they could dart in, attack, and then withdraw to a safer distance.

If all else failed, their crews had orders to ram Supertank. That meant certain destruction, but the resultant explosion of their remaining energy piles would cause some damage to the monster's engines. Would this desperate defence be enough to save the remnants of a once over-proud humanity?

That, then, is the scene set for the game of Supertank, a wargame for one player against the computer. Because of its

length, I had to split the game into two programs to implement it on my 8K Pet and in these two articles I shall describe the two programs and discuss some of the lessons and techniques I learned during their development. Firstly, let me acknowledge the inspiration I have derived from playing various wargames, but most notably, in this instance, I was influenced by Ogre, a game from Metagaming.

Design criteria

Having played games like this, I was keen to attempt something similar for the Pet. I started by setting myself a number of design criteria and it may be helpful to review these here:

The game map should occupy as much of the screen as possible to allow reasonable movement of forces.

The map should contain some terrain features, however simple, and they should vary from game to game. That adds variety to the game and prevents identical games occurring.

The defender should have control over the initial deployment of his resources, so that different strategies can be tried. Again, that adds variety to the game.

There should be two types of defensive unit — one fixed and one mobile. Each of them has its own characteristics and their use increases the tactical and strategic choices which must be made.

The starting point of Supertank should not be revealed until after the defence is

deployed, forcing the defence to cover a wide range of possibilities. The final target is to be kept secret until after Supertank reaches it and then the defender is to be given one last chance.

As a further contribution to variety, the number of defenders should vary, within limits, from game to game.

Having decided on the criteria, it was obvious that the game would probably not fit into 8K of memory. I would have to split it into two programs and the first decision was where to make the split.

The game fell into three main segments — the instructions, the initial deployment of forces, and the game itself. With the benefit of hindsight, it is, in fact, just about possible to put the instructions in one program and have the active parts of the program on their own.

However, at this stage I had little idea of the final requirements of the program and, in any case, felt that spare space in the second program would enable me to add further refinements to the program later. Besides, making the split after the defenders had been deployed and most of the variables established would involve techniques which I was keen to master and I decided, therefore, to adopt this approach.

Data storage

We shall discuss the problems encountered in using the ability of the Pet to load one program in the space used by another, while retaining the variables from the first program, in the next article.

The next decision concerned the method of storing all the details shown on the map. I had decided to use the first 20 lines for the map, leaving the bottom five lines for input and message requirements. That gives a map area of 40 × 20 which was reduced to 39 × 19 to include a guide to the X-Y co-ordinates along two edges of the map.

My first plan was to keep all the points of the map as elements in arrays in memory and my first efforts were directed along these lines. It soon became clear, however, that this approach was impracticable, as there were 741 points to be recorded and each element in the array needs seven bytes or more.

That would leave very little space for a reasonable program, but how could I carry forward all the required details without using too much memory? In the end, I hit on the obvious solution — one which used the 1K of memory not needed for the program or its variables — I used the screen as my means of storage.

Once the map has been set-up in the first program, it stays on the screen while the second is being loaded. Great care has to be exercised at all times to ensure that the screen is not scrolled by any of the messages which appear at the bottom of the screen.

Now let us consider the program itself. Table I gives a list of the principal variables used. Lines 100-990 contain the

instruction sequence and are fairly self-explanatory.

Most lines of print start with a cursor down to give double spacing and improve readability. At the end of each page, the program waits for a key press before clearing the screen and continuing.

It is not completely idle during this period, however, as the key-press subroutine also runs through random numbers while it is waiting, ensuring that the sequence of random numbers for the game will be different every time.

Line 1010 sets-up two strings containing cursor-right and cursor-down instructions. They are used to access any point on the screen, using such instructions as PRINT LEFTS (ACS,X) : LEFTS (DNS,Y)

Line 1020 sets the number of defending mobiles, MN, and artillery units, AN. It also stores the values of Supertank's engines, SM, and firepower, SF. The line has a great bearing on the balance of the game.

When you first play, you may well find that Supertank is too powerful, but after

List of main variables

MN	Number of mobiles
AN	Number of artillery units
N	Total of units; MN + AN
SM	Supertank's engines
SF	Supertank's firepower
MM(MN)	Mobiles' engines; 1 to MN
MF(MN)	Mobiles' firepower; 1 to MN
MX(MN)	Mobiles' x co-ordinates; 1 to MN
MY(MN)	Mobiles' y co-ordinates; 1 to MN
AF(AN)	Artillery firepower; 1 to AN
AX(AN)	Artillery x co-ordinates; 1 to AN
AY(AN)	Artillery y co-ordinates; 1 to AN
TX	X co-ordinate of target location
TY	Y co-ordinate of target location
SX	Supertank's x co-ordinate; initially 1
SY	Supertank's y co-ordinate

you have refined your tactics, you will discover that it can be beaten. The values given here are ones that I hit on after the initial play-testing, but now I find I can usually beat Supertank at these levels.

By changing the values of SM and/or SF more powerful versions of Supertank can be fought. It is also a simple matter to include a short program giving a choice of enemies — that is left for you to implement.

After the number of units available have been displayed in lines 1030-1040, the program forms arrays containing the appropriate number of segments for storing movement factors, firepower and position for the defending units — 1050-1060.

Lines 1070 and 1080 are used to print co-ordinates along the top and left-hand edges of the map and the terrain features are added. They are simply craters, represented by an asterisk, and prevent movement by either side. Defending units cannot be placed in these spaces.

That simple terrain feature was forced on me by the use of the screen as the means of storing the map, since once the

feature is obliterated by another unit moving through it, it would be difficult to restore it to the display.

Once the map is drawn, the player can enter his units on the map. First he places the mobiles. That is done in lines 1120-1180 and consists of entering the co-ordinates X,Y of the point on the map.

Most of this section is concerned with checking the idiot factor. Line 1140 checks that the values entered are within the allowed limits, calling-up the error message in subroutine 1330 if they are not.

Subroutine 1360 calculates the screen memory value of the desired point and this location is checked in 1150 and 1160 to see if it is already occupied by a crater or another unit.

Error messages

The appropriate error messages are in subroutines 1340 and 1350. If all is well, the unit is placed on the map. It is represented by the reverse number of the mobile. Its position is also stored in the appropriate cells of arrays MX(I) and MY(I).

Subroutine 1310, called in line 1130, clears the bottom five lines of the screen and sets the cursor to the start of the twenty-first.

Lines 1200-1240 perform the same routine for the artillery units. Line 1250 sets the secret destination for Supertank and that is checked to see it is possible for Supertank to occupy it — it cannot if the destination is already occupied by an artillery unit or a crater.

Finally, Supertank is placed at random in the left-hand column of the map, but not in a crater of course, its symbol is printed, the bottom of the screen cleared and LOAD "GAME" is ordered.

That places "GAME" into the same space as this first program which means that "GAME" must be the same length or shorter. All the variable values we have derived in this first program remain in memory and can be used by the second program.

The map with all its details stays on the screen and it is necessary to clear the bottom of the screen since, if the cassette has not been left in PLAY after the first program, the message "PRESS PLAY ... etc." will appear, followed by OK which can cause scrolling.

The next article will discuss the game itself, but I will conclude with a few suggestions with which you may care to experiment when you have tried the program in its basic form.

I have already mentioned the possibility of altering the balance of the game by playing with the values of SF and SM. You could also try different values of MM(I), MF(I) and AF(I). The terrain could play a different role if the craters were more dense.

That can be achieved by reducing the value 97 in line 1100. These are just a few possibilities and I hope you will find a few more.

(continued on page 83)

image data

takes the lid off the
microcomputer
market

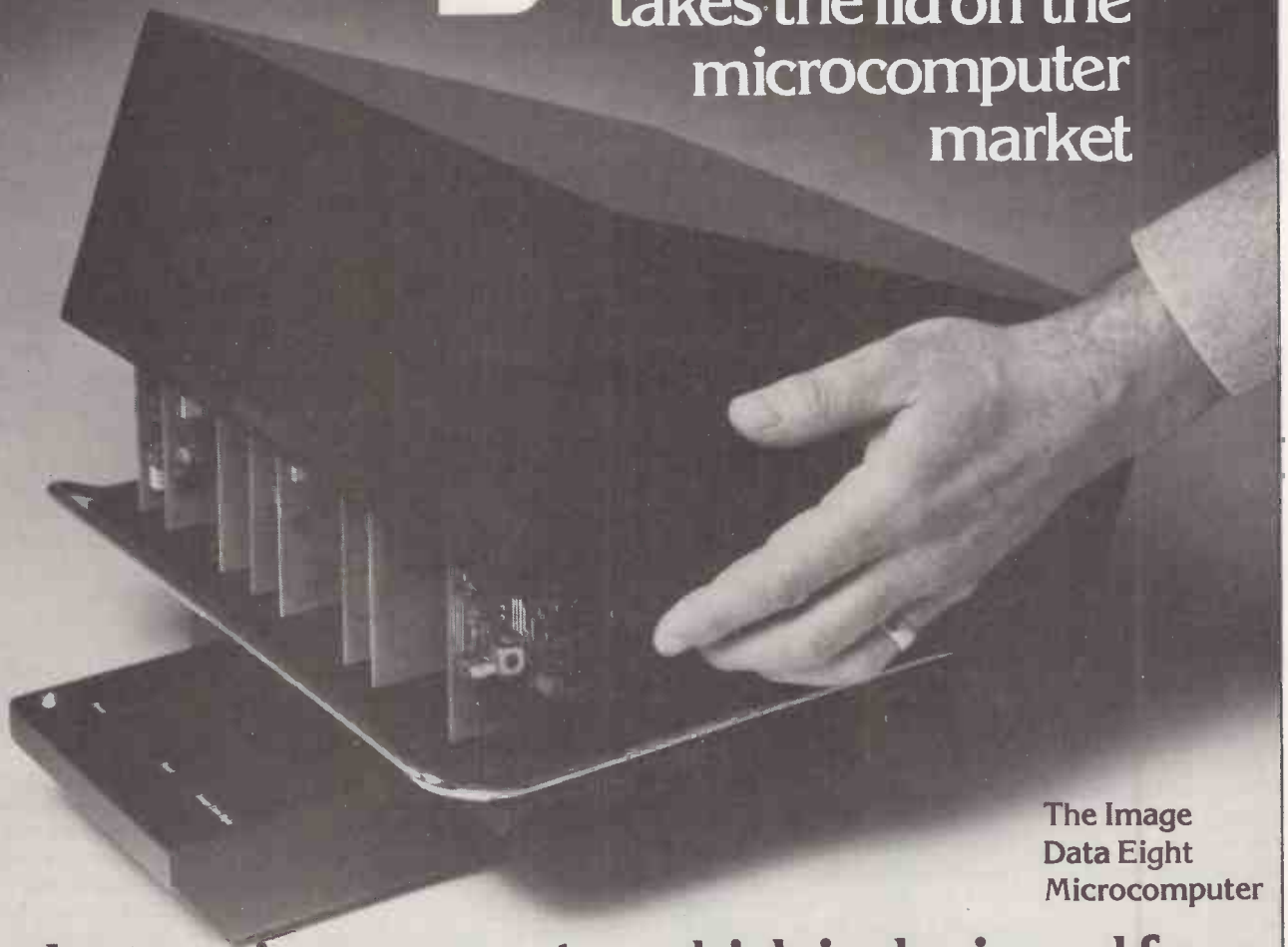

The Image
Data Eight
Microcomputer

at last a microcomputer which is designed for
good looks, ease of access and
expandability.

Equally suited to applications in
Commerce, Education and Industry,
as a dedicated, development or
control system.

- ★ 19" rack mount version
- ★ International third party
maintenance support
- ★ Full range of supporting
peripherals
- ★ Comprehensive system and
application software



image data

Image Data Products Limited
1-4 Portland Square,
Bristol BS2 8RR.
Telephone: 0272 40248/9
Telex: 449752 Chacom G
(Prefix all messages 'Image')

(continued from page 81)

```

100 PRINT" ]          2SUPERTANK"
110 PRINT"XXXXTHIS PROGRAM CONTAINS THE INSTRUCTIONS"
120 PRINT"XAND THE SET-UP SEQUENCE FOR THE GAME OF"
130 PRINT"XSUPERTANK. IF YOU DO NOT WANT TO READ"
140 PRINT"XTHE INSTRUCTIONS, PRESS 'N'. PRESS 'Y'"
150 PRINT"XFOR THE INSTRUCTIONS. AFTER EACH PAGE"
160 PRINT"XOF INSTRUCTIONS, YOU CAN PRESS ANY KEY"
170 PRINT"XTO CONTINUE":GOSUB1290 :IFR#="N"THEN1000
180 IFR#="Y"THEN200
190 PRINT"XPLEASE PRESS 'Y' OR 'N':GOTO170
200 PRINT" ]THIS IS SUPERTANK:XXXX"
210 PRINT"XIT MAY NOT LOOK MUCH, BUT IT IS REALLY"
220 PRINT"XQUITE POWERFUL. IT HAS A FIREPOWER OF"
230 PRINT"X300 MISSILE LAUNCHERS AND USES 300"
240 PRINT"XENGINES TO MOVE ITS GREAT BULK, AS WELL"
250 PRINT"XAS THIS, IT CARRIES A POWERFUL NUCLEAR"
260 PRINT"XDEVICE, WHICH HAS BEEN PROGRAMMED TO"
270 PRINT"XEXPLODE SHORTLY AFTER SUPERTANK REACHES"
280 PRINT"XA SECRET DESTINATION, DEEP INSIDE YOUR"
290 PRINT"XTERRITORY. YOUR MISSION IS TO STOP IT"
300 PRINT"XAT ALL COSTS!!!":GOSUB1290
310 PRINT" ]YOU WILL HAVE BETWEEN 6 AND 10 MOBILE"
320 PRINT"XMISSILE TANKS AND 3 TO 5 FIXED ARTILLERY"
330 PRINT"XSITES. THESE HAVE A FIREPOWER OF 10 AND"
340 PRINT"X300 MISSILE LAUNCHERS, RESPECTIVELY. LIKE"
350 PRINT"XSUPERTANK, THE EFFECTIVENESS OF THE "
360 PRINT"XWEAPONS REDUCES WITH RANGE. YOU WILL "
370 PRINT"XNEED TO MOVE YOUR MOBILES QUITE CLOSE"
380 PRINT"XTO SUPERTANK IF YOU ARE TO HIT IT OFTEN"
390 PRINT"XENOUGH TO STOP IT. YOU WILL BE GIVEN"
400 PRINT"XTHE CHOICE OF AIMING AT ITS ARMAMENT OR"
410 PRINT"XITS ENGINES. YOUR AIM WILL BE COMPUTER"
420 PRINT"XCONTROLLED.":GOSUB1290
430 PRINT" ]THE MOBILES CAN BE MOVED UP TO 3 SPACES"
440 PRINT"XAT A TIME. MOVEMENT IS CONTROLLED BY THE"
450 PRINT"XKEYPAD:      7 8 9"
460 PRINT"               |\"
470 PRINT"            4-5-6"
480 PRINT"               |\"
490 PRINT"            1 2 3"
500 PRINT"XPRESS 5 TO STAND STILL. NEITHER YOU NOR"
510 PRINT"XSUPERTANK CAN MOVE INTO A CRATER(*), BUT"
520 PRINT"XMUST STAY IN CLEAR TERRAIN. WHEN YOUR"
530 PRINT"XENGINES ARE DESTROYED BY SUPERTANK'S"
540 PRINT"XFIRE, YOUR MOVEMENT WILL BE REDUCED. YOU"
550 PRINT"XHAVE 30 ENGINES ON EACH MOBILE AND NEED"
560 PRINT"XA MINIMUM OF 5 TO MOVE.":GOSUB1290
570 PRINT"XIN DESPERATION, YOU CAN RAM SUPERTANK."
580 PRINT"XTHIS WILL DESTROY YOUR MOBILE, BUT CAN"
590 PRINT"XDAMAGE SUPERTANK'S ENGINES AND, PERHAPS,"
600 PRINT"XSLOW IT DOWN. SUPERTANK IS PROGRAMMED "
610 PRINT"XTO MOVE TOWARDS ITS SECRET DESTINATION"
620 PRINT"XAND WILL RAM ANY MOBILE THAT GETS IN ITS"
630 PRINT"XWAY, ALTHOUGH ARTILLERY SITES ARE TOO"
640 PRINT"XBIG TO RAM. IF IT RAMS A MOBILE, IT WILL"
650 PRINT"XDESTROY THE MOBILE, BUT WILL ALSO HAVE"
660 PRINT"XSOME OF ITS OWN ENGINES DESTROYED.":GOSUB1290
670 PRINT" ]THE ORDER OF MOVES IN THE GAME IS:"
680 PRINT" ]  1>YOU MOVE YOUR MOBILES"
690 PRINT" ]  2>YOU ATTACK WITH EACH UNIT IN TURN"
700 PRINT" ]  3>YOU CAN MOVE AGAIN"
710 PRINT" ]  4>SUPERTANK MOVES"
720 PRINT" ]  5>SUPERTANK ATTACKS"
730 PRINT"XSUPERTANK DIVIDES ITS FIREPOWER EQUALLY"
740 PRINT"XAMONG ALL YOUR UNITS THAT STILL HAVE"

```

(continued on next page)

(continued from previous page)

```

750 PRINT"NEITHER ENGINES OR MISSILES. AS YOUR "
760 PRINT"UNITS ARE DESTROYED, MORE OF SUPERTANK'S"
770 PRINT"MISSILES CAN BE AIMED AT THE SURVIVORS!":GOSUB1290
780 PRINT"ONCE SUPERTANK REACHES ITS DESTINATION,"
790 PRINT"YOU WILL HAVE ONE LAST ATTACK IN WHICH"
800 PRINT"TO DESTROY ITS REMAINING ARMAMENT AND"
810 PRINT"ENGINES. IF YOU FAIL, THEN THE BOMB IS"
820 PRINT"DETONATED. SHOULD YOU IMMOBILISE SUPER-"
830 PRINT"TANK, BY REDUCING ITS ENGINES TO LESS"
840 PRINT"THAN 10. THEN YOU MUST ALSO DESTROY ITS"
850 PRINT"ARMAMENT. IF YOU RUN OUT OF FIREPOWER"
860 PRINT"BEFORE THIS IS DONE, THE BOMB WILL STILL"
870 PRINT"EXPLODE. NOTE THAT RAMMING SUPERTANK "
880 PRINT"WILL NOT DESTROY MISSILE LAUNCHERS.":GOSUB1290
890 PRINT"NOW YOU WILL BE ASKED TO PLACE YOUR "
900 PRINT"UNITS ON THE MAP. THIS WILL BE DONE BY"
910 PRINT"ENTERING COORDINATES IN THE FORM X,Y."
920 PRINT"X IS THE NUMBER OF SPACES HORIZONTALLY"
930 PRINT"(RANGE 2-39) AND Y IS THE NUMBER OF"
940 PRINT"SPACES VERTICALLY (RANGE 1-19). "
950 PRINT"THE COMMA IN THE ENTRY IS IMPORTANT."
960 PRINT"ARTILLERY UNITS ARE SHOWN AS SA. WHILST"
970 PRINT"MOBILES ARE IDENTIFIED BY NUMBER-E.G. 25"
980 PRINT"YOU CANNOT PLACE ANY UNIT IN A CRATER(*)"
990 PRINT"OR IN THE LEFT-HAND ROW(X=1)":GOSUB1290
1000 PRINT"PLEASE WAIT WHILE THE MAP IS DRAWN"
1010 AC$="":IN$="":
1020 MN=INT(5*RND(1)+6):AN=INT(3*RND(1)+3):N=AN+MN:SM=300:SF=200
1030 PRINT"YOU HAVE":MN:"MOBILES AND":AN:"ARTILLERY"
1040 PRINT"UNITS":FORI=1TO2000:NEXT
1050 DIMM(MN),MF(MN),MX(MN),MY(MN),AF(AN),AX(AN),AY(AN)
1060 FORI=1TOMN:MM(I)=30:MF(I)=10:NEXT:FORI=1TOAN:AF(I)=30:NEXT
1070 PRINT" ":FORI=1TO39:PRINT" ";LEFT$(AC$,I);RIGHT$(STR$(I),1):NEXT
1080 FORI=1TO19:PRINT" ";LEFT$(IN$,I);RIGHT$(STR$(I),1):NEXT
1090 FORI=1TO19:FORJ=1TO39:R=100*RND(1)
1100 IFR>97THENPRINT" ";LEFT$(AC$,J);LEFT$(IN$,I):"*"
1110 NEXTJ,I
1120 FORI=1TOMN
1130 GOSUB1310:PRINT"ENTER COORDINATES(X,Y) OF MOBILE #":I
1140 INPUTX,Y:IFX<2ORX>39ORY<1ORY>19THENGOSUB1330:GOTO1130
1150 GOSUB1360:IFPEEK(R1)=42THENGOSUB1340:GOTO1130
1160 IFPEEK(R1)<>32THENGOSUB1350:GOTO1130
1170 I$=STR$(I):MX(I)=X:MY(I)=Y
1180 PRINT" ";LEFT$(AC$,X);LEFT$(IN$,Y):" ";RIGHT$(I$,1):" ":NEXT
1190 FORI=1TOAN
1200 GOSUB1310:PRINT"ENTER COORDINATES OF ARTILLERY #":I
1210 INPUTX,Y:IFX<2ORX>39ORY<1ORY>19THENGOSUB1330:GOTO1200
1220 GOSUB1360:IFPEEK(R1)=42THENGOSUB1340:GOTO1200
1230 IFPEEK(R1)<>32THENGOSUB1350:GOTO1200
1240 PRINT" ";LEFT$(AC$,X);LEFT$(IN$,Y):" SA":AX(I)=X:AY(I)=Y:NEXT
1250 TX=INT(10*RND(1)+30):TY=INT(19*RND(1)+1)
1260 IFPEEK(32768+TX+40*TY)=42ORPEEK(32768+TX+40*TY)=129THEN1250
1270 SX=1:SY=INT(19*RND(1)+1):IFPEEK(32768+SX+40*SY)=42THEN1270
1280 PRINT" SA":LEFT$(IN$,SY):" SA":GOSUB1310:PRINT" ";LEFT$(IN$,19):LOAD"GAME"
"
1290 R=RND(1):GETR$:IFR$=""THEN1290
1300 RETURN
1310 PRINT" ";LEFT$(IN$,20):FORK=1TO199:PRINT" ":NEXT
1320 PRINT" ";LEFT$(IN$,20):RETURN
1330 PRINT"ILLEGAL VALUE":RETURN
1340 PRINT"NOT IN A CRATER!":RETURN
1350 PRINT"SQUARE OCCUPIED!":RETURN
1360 R1=32768+X+40*Y:RETURN
READY.

```



TELEPHONE
0734 595269
READING, BERKSHIRE. (24 HOUR SERVICE)

audiogenic

LATEST NEWS
ORACLE PAGE 451

MAIL ORDER
PO BOX 88
READING, BERKSHIRE.



GAMES

MP 040 OSC Lunar Lander
Rotate
Wumpus

MP 041 3D Tac Tac Toe
Jumbo Jet Lander
Target Pong
Draw Poker
Galaxy Games

MP 042 Galactic Lander
Off the wall!
Wrap Trap
Space Trek

MP 043 Super 9 x 9
Formula 1

MP 045 Backpack
Space Fight
MP 044
Gridler
Awards
Othello
Reverse

MP 051 Polaris
Star Trek

MP 052 Priapoly
Sorcerer's
Castle

MP 053 Jason & the
Argonauts
MP 055
Dodge City

MP 056 Molecules &
Atoms
Horse Race
One Arm
Bandit

MP 066 Squadron
Scramble
Tower of Hanoi
Sublinker

MP 067 Minefield

MP 068 MP 069

TREASURE TROVE OF GAMES NO: 1 £10.00
You control the landing of the module on the moon. Put the letters into sequence in as few moves as possible. On the basis of the clues given, find the Wumpus before he finds you.

TREASURE TROVE OF GAMES NO: 2 £10.00
You are the pilot in this simulation game. Deflect the moving ball to hit the target. Your PET clears the cards - you place your bet and play. Two amazing space battle games.

TREASURE TROVE OF GAMES NO: 3 £10.00
Guide Concorde to the runway and land - if you can. Negotiate 8 Crosses with a new dimension.

TREASURE TROVE OF GAMES NO: 4 £10.00
Play large scale Knights & Crosses against your PET. Two versions for old and new rom machines. Grand Prix Game for 1-4 players. Choose from 4 different circuits. Gamble without losing money. Galactic juggling for 2 players.

TREASURE TROVE OF GAMES NO: 5 £10.00
Guide the glider to its landing place. PET version of the ancient African game. Game of strategy on 8 x 8 board, you versus PET. Put randomly jumbled sequence of numbers into correct order in as few moves as possible.

TREASURE TROVE OF GAMES NO: 6 £10.00
Take on your PET at Backgammon. PET version of the Mastermind game of logic. Design the cellular structures necessary to sustain life in future generations. Destroy enemy shipping on your very own nuclear submarine.

TREASURE TROVE OF GAMES NO: 7 £10.00
Rid the galaxy of the evil Klingons. Light years of fun using this advanced Star Trek.

TREASURE TROVE OF GAMES NO: 8 £10.00
A sophisticated PET version of the classic board game. A game of fantasy adventure in which you must capture the Sorcerer's treasure and escape intact from his castle. Join the quest for the Golden Fleece.

TREASURE TROVE OF GAMES NO: 9 £10.00
You are the sheriff and you must get rid of 100 outlaws who are out to get you. Deduce the molecular structure of atoms 'created' by your PET.

TREASURE TROVE OF GAMES NO: 10 £10.00
Lead your squadron of Spitfires into battle against the enemy bombers. Dynamite and rescue the tower in as few moves as possible. Protect your convoy by destroying the enemy subs with your depth charges. Guide your ambulance round the minefield picking up the injured but don't hit the mines!

ARCADE SERIES NO: 1 - INVADERS £7.00
The PET version of the 'Space Invaders' games that is sweeping the nation.

ARCADE SERIES NO: 2 - ACROBAT £7.00
Another game popular in the pubs and clubs of the land. Control the use you on which two men are bouncing up and down. Hitting the moving balloons above them.

ARCADE SERIES NO: 3 - 3D STARTREK £7.00
The ultimate Star Trek game. See the stars on by as you zoom through space in hard drive on your mission to save the universe. Tread boldly! Instruction booklets supplied.

EVERY PROGRAM ALWAYS IN STOCK

CATALOGUE ON REQUEST

MP 054 VIRUS, ABUSE, GENERAL CONVERSATION & WORDS 1 & II £10.00
Put your wits against 8 deadly diseases. An incredible program which will make you feel like punching your PET in the VDU. Ever charged up a computer? This program will lead to a profound, fulfilling relationship with your PET. Two programs in which words and graphics create new art forms.

MP 060 PET SHOW £6.00
Four programs which highlight the PET's amazing graphic capabilities.

MP 016 DIET PLANNER & BIORHYTHM £5.00
Diet Planner
Helps you plan your caloric intake according to the ideal weight for your body frame, height, sex and age. Draws an incredible graph of your emotional, intellectual and physical cycles. Projects into the future or past.

EDUCATIONAL

MP 001 BASIC BASIC £9.00
A well contained course in Basic for beginners.

MP 002 SQUIGGLE/BIG TIME £4.00
Illustrates programmed cursor movement, graphics characters and random function.

MP 026 Big Time
Displays the PET's timing capabilities.

MP 039 SNARK £10.00
A machine code programming simulator.

MP 046 STRATHCLYDE BASIC £12.00
The ultimate beginners' course in Basic. Includes cassette program and work book vital for PET newcomers.

MP 053 PHYSICS PACK 1 £10.00
Provides simulation of some standard physics experiments including: projectile, coils, random decay, strobe and momentum.

MP 061 PHYSICS PACK 2 £10.00
As Physics Pack 1 but dealing with structure of atoms, alkane compounds, & 10 Mollan experiments.

MP 062 INTRODUCTION TO ALGEBRA £20.00
Three cassettes and instruction book take the pupil gradually up to 'O' level standard.

MP 063 MATHEMATICAL GAMES £10.00
A series of number games, particularly suitable for 8-18 year olds which provide enjoyment and insight into how numbers work.

MP 064 SAMPLING £10.00
This program can be used to illustrate several different parts of a course in elementary probability and statistics.

MP 056 LANGUAGES £10.00
Provides a series of tests in French, German, Italian, Spanish, Dutch and Danish.

SCIENTIFIC AND ENGINEERING

MP 058 LOGICA AND KARNAUGH MAPPING £10.00
Two programs to aid in the design and testing of logic circuits.

MP 047 FAST FOURIER TRANSFORMS £15.00
A series of programs concerned with the harmonic analysis of signal waveforms.

MP 048 LINEAR CIRCUIT ANALYSIS £10.00
Lumen pattern circuit analysis and linear electronic circuit analysis.

PETSET £15-75
GETS PET OUT OF CRASHED CONDITIONS WITHOUT LOSING BASIC. EASILY INSTALLED.

MECHANICS OF MATERIALS £15.00
A series of programs to aid the engineer in various fields including statics, stress and strain, beams and framed structures, etc.

MP 070 R.L.C. CIRCUIT ANALYSIS £10.00
Plots the response of the R.L.C. series circuit to a number of variables. Another program caters for R.L.C. parallel circuit analysis.

MP 071 DRAWING LOAD AND DIE DESIGN £10.00
Two programs to solve problems of interest to engineers, metallurgists and physicists.

BUSINESS

MP 022 and MP 023 ROCKSTOCK ARDENSTOCK £20.00 £15.00
Two stock control programs for the small and not so small business.

MP 024 DATA BASE UTILITY £15.00
Enables the user to create a computerised filing system.

MP 025 COST ESTIMATION £10.00
A cost report generating system.

MP 027 SURVEY ANALYSIS £8.00
Analyses the results of a small to medium sized questionnaire survey.

MP 009 MORTGAGE ANALYSIS £6.00
Calculates the status of your mortgage or loan at any date.

MP 033 BOOKS £12.00
Accounting program for the small business or the accountancy student.

MP 057 STOCK MARKET TRENDS £15.00
Analyses movements in the market providing a guide for investment.

MP 021 PAYROLL £50.00
Two programs, one for 8k and one for 16k and 32k PETs. Processes the payroll of the smaller business.

MATHEMATICS

MP 007 BASIC MATHS £15.00
Six programs to aid the mathematician in geometry, calculus and algebra.

MP 008 BASIC STATISTICS 1 £15.00
A series of tests to run on your data.

MP 030 BASIC STATISTICS 2 £15.00
See more tests.

MP 050 NUMERICAL METHODS PACK 1 £15.00
Contains two programs, "The Solution of Differential Equations" and "The Solution of Nonlinear Equations".

MP 049 LINEAR PROGRAMMING £10.00
A Basic program with corresponding algebraic methods to solve linear programming problems.

MP 055 BEST LINE AND LEAST SQUARES £10.00
Two programs for the graphical display of correlation and curve fitting.

PROGRAMMING AIDS

MP 031 USER PORT COOKBOOK £10.00
A program for connecting devices to the user port.

MP 003 DISASSEMBLER £10.00
6500 Series full disassembler.

MP 004 MACHINE CODE PACK £10.00
Comprises of machine code handler, machine language monitor and hex editor and loader.

GD 010 LISP (DISK) £75.00
Interpreted language for research into artificial intelligence.

GD 001 ASSEMBLER DEVELOPMENT SYSTEM (DISK) £50.00
Aid to programming in machine code or Basic, includes tool kit, functions, EXTRA MON AND DOS SUPPORT.

ACCESSORIES

BLANK VERBATIM DISKS PER BOX OF 10 £26.00
BLANK CASSETTES PER PACK OF 5 C5 £2.50, C10 £2.75
THE PET REVEALED BY NICK HAMPSHIRE £9.95
6500 PROGRAM MANUAL £5.00
6500 HARDWARE MANUAL £5.00



SEE US ON STAND 58 AT MICRO '88 EVERYTHING ON SALE

CHEQUES AND POSTAL ORDERS TO AUDIOGENIC SOFTWARE OR QUOTE CARD AND NUMBER
POST AND PACKAGE 25p FIRST ITEM THEREAFTER 10p PER ITEM ALL PRICES INCLUDE VAT

Successful business?...

Yes, with the megamicro

average installed system
less than **£8000** plus VAT

complete with
Hardware including printer
Software including programs
Staff training
Installation & delivery
Support by manufacturer

British built by:
Bytronix Microcomputers Ltd, 83, West Street, Farnham.
Telephone: (0252) 726814

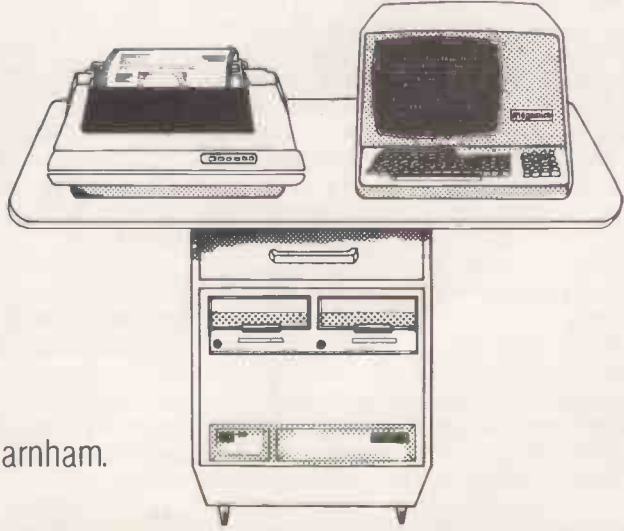

• Circle No. 170

Curing administrative ills with computer treatment

Duncan Scot looks at how microcomputers can be used by family doctors, assesses some of the packages on the market and reviews the moves by the Royal College of General Practitioners and the British Medical Association to set the standards to which medical packages will have to conform.

AS A PRIVATE doctor, with a practice in London's Wimpole Street, Barry Grimaldi has fee-paying patients from all over the world. As a self-employed man, he is always seeking more efficient ways of running his surgery. Installing a computer seemed an obvious way to reduce paperwork.

"I knew that some U.S. doctors were using small computers", says Grimaldi, "but the first inkling I had of the kind of computer on the market was from looking in the shops in London's Tottenham Court Road". Grimaldi bought his first computer, a Pet, from the Byte Shop and, after a few weeks in which he taught himself some Basic, started to devise a program for his practice.

Private doctors work on very different lines from the family doctor employed by the National Health Service, mainly because of the way they are paid. The family doctor is paid a standard fee according to the number of patients who are registered with the practice and not according to how many patients have to be treated every year.

Patient records

Grimaldi, on the other hand, not only decides which patients to accept for treatment, although he is obviously unlikely to turn any away, but is paid according to the treatment which each patient requires. On average, he deals with about 1,000 patients each year and keeps records on at least 5,000 who have received treatment or who might have to be recalled for check-ups.

The requirements Grimaldi set for his own system were that it should be able to store records on all 5,000 patients and process those records to provide a detailed analysis of, for example, the number of patients being treated for a certain condition. Each entry would have to include a code with which the system could analyse the practice workload. Unlike a doctor in the National Health Service, Grimaldi has to keep detailed financial records and invoice all his patients.

In the early stages, a multi-terminal system seemed to offer the best solution. He planned to have one terminal in his surgery, with which he could study his patient records, and another in his secretary's office. In a part exchange deal with the Byte Shop, he returned the Pet and bought a 48K North Star Horizon, a

Volker-Craig VDU and a small Anadex matrix printer.

The first set-back was when Grimaldi discovered that not only were there no medical packages which he could adapt for his practice but that it was not possible, as he had assumed, to buy a selection of subroutines which he could string together to make his program. He could not even find someone who could offer him a standard file-handling package; Grimaldi ended up writing the entire program himself.

The full program is stored on one 5.5in. floppy disc and falls into two parts; the medical files and the financial files. When



Dr Barry Grimaldi.

the program is run, the following menu is displayed:

- 1 Patient files
- 2 Medical report
- 3 Accounts
- 4 Transactions
- 5 Enquiries
- 6 Billings
- 7 Reports
- 8 Security

The medical files, items 1 and 2, are stored on another 5.5in. floppy disc. The other items refer to the financial-control routines.

The patient files include details of the name, age, sex and address of each patient and are followed by a short narrative of the patient's medical record. Each patient can be identified, via a short code, by age, sex, complaint or by treatment. These codes are used for a detailed sorting of patients to identify any category he might require.

"One simple example", explains Grimaldi, "is when I need a list of all the

patients over forty who are due for a check-up for breast cancer in August. Now I simply specify all the codes in which I am interested and the computer will print-out a list of all my patients with that combination of codes. I can then write to those patients and remind them that they are due for recall.

"Eventually, I should be able to make the computer write all the letters. Before I had the computer, it used to take my secretary hours to check through a manual age/sex register and select all the relevant cards".

As yet, Grimaldi uses only one terminal and has doubts about whether a multi-terminal system would offer any additional advantages. "The system has proved very useful in other ways", says Grimaldi. "The notes I keep on my patients are far more organised as I have to keep my observations to the point to fit them into the space". As a final bonus Grimaldi has now been approached by a software publishing house which offers to adapt his program for other microcomputers and sell it throughout the U.K.

Specialist interest

The market for a package like Grimaldi's is probably limited to private doctors with some specialist interest. Every National Health Service family doctor has to deal, on average, with about 2,500 patients of which about 10 percent call on a regular basis. About one third of the 26,000 family doctors, or general practitioners (GPs), in the U.K. work in group practices with total patient lists of up to 10,000. Few microcomputers could offer sufficient capacity to store narrative records for such a large number.

Some packages have been written specifically as a way of introducing computers to this kind of group practice. One of the best known has been written by Ipswich GP, David Meldrum. Based on a 32K Pet and using cassette storage, his package is now marketed by Medicom, an offshoot of Adda Computers in London.

As in Grimaldi's system, every patient is given a code but no other details are kept on the system. Patrick Dixon of Medicom points out that the system can work only if a detailed manual record is already kept. When a doctor sees his patient, he has to write a brief record and allocate the patient an appropriate code. The practice secretary will then enter all the codes at the end of every week.

According to Dixon, the analysis of the codes on the Pet can yield valuable medical information. In Meldrum's practice, when it was discovered that the practice trainee had not treated any patients for diabetes, the practice workload was re-distributed to give the trainee the experience he lacked.

"There are many other advantages", says Dixon. "One can keep an accurate monitor of all the high-risk or elderly patients treated, analyse the practice workload by age, sex, doctor or disease; analyse disease patterns and associations and prescriptions. Eventually, one should be able to collect a good deal of useful information on how successful new drugs have been".

Detailed records

Another attraction of the system is that doctors can keep detailed records of all the services such as vaccinations and the fitting of contraceptives, for which they can claim extra money from the Department of Health and Social Security. This works in two ways. Doctors can identify those patients who are due to be called in for one of the services and they can then keep a detailed record of the number of claims they should submit.

The Medicom practice monitor package is sold for around £1,300 and has now been accepted on the Commodore list of approved packages. It will also, shortly, be available on disc. Medicom plans to release a number of other packages later this year.

One is a disc-based system on which doctors can keep a list of every patient registered with a practice for the specific purpose of identifying patients who can be called in for those services of preventative medicine for which the doctor can claim an extra fee.

The Royal College of General Practitioners recently formed a working party
Lee Morris, Dr Grimaldi's assistant, with the North Star Horizon.

to study the medical systems on the market and offer doctors some advice on how to choose one suitable for their practice. Professor Metcalfe of the Department of General Practice at the University of Manchester, and a member of the working party, believes that it will be some time yet before the majority of GPs can be persuaded to use micro-computers.

Cross-indexing

He points out that although the College has long recommended the use of manual cross-indexing systems, only a few doctors have accepted the need. "Most doctors do not keep effective records anyway", he says. "They are taught during their training about how to write down medical observations but they are taught nothing about information handling.

"When I ran my own practice I was regarded as being slightly nutty as I kept detailed manual records for all my patients. Most doctors can't see the rewards of this kind of system, even in terms of patient care. It is normally regarded as some kind of research tool".

The British Medical Association shares this view but is eager to go further and establish some hardware and software specifications which doctors can follow. The man behind these moves is BMA under-secretary, Dr John Dawson, a keen computer hobbyist. At his instigation, the BMA has decided to commission a £21,000 study, by Scicon, to do the fundamental systems analysis.

Dawson agrees that the initial problem is to persuade GPs to keep good manual records. "I certainly do not think that at this stage we will see doctors keeping narrative records on computers", he says. "Most applications will involve the computer doing its work in batch form, with the practice secretary typing in all the data. It is more cost-effective and it does

not require more work by the GP.

"I do believe that it is important to spend a long time deciding how one is going to use a computer. I know of one practice which spent nearly 18 months studying their working habits, before deciding they did not really need a computer. But the result was a positive one in that they revised and modernised their methods of record keeping".

Within a few years, Dawson hopes that doctors will be able to offset the cost of buying computers by claiming the investment back from the DHSS, as long as the equipment falls within the BMA specifications.

"In the longer terms", he says "it will obviously be important for doctors to have access to some common source of information on items such as new drugs and their side-effects.

"I would also like to see a way in which we could collect information from GPs all over the country so we can analyse the national trends". Prestel could be an ideal medium for this kind of information and Dawson expects that the guidelines, when they are finally established, will require doctors to choose microcomputers which can be interfaced to the Prestel network.

Encouraging sign

The well-established software houses have not proved keen to tackle this market, partly because the potential rewards are insignificant when compared to the more straightforward business applications. It is, however, an encouraging sign for everybody that the professional bodies are beginning to face some of the challenges presented by the microcomputer and are showing some willing to promote its use. If the BMA can persuade the DHSS to reimburse the cost of buying computer systems, the temperature of this particular market will certainly rise quite sharply.



SHEFFIELD COMPUTER CENTRE

The Complete Service for Yorkshire & North Midlands

COMMODORE PET £475

8K with Cassette, 16 & 32K PETs 3022
Printer with graphics CBM Dual Disk Drive,
Compu/Think Dual Disk Drive 400 & 800Kb.

BUSINESS SOFTWARE: We are official
Commodore Business Software Dealers and
have over 20 business packages available for
PET based systems.

APPLE II £695

16K expands to 48K RAM. One to six 5¼"
Disk Drives, 8" and Winchester Drives
available.

Floating point or Integer BASIC, PASCAL,
Colour Card, High Resolution Graphics, Music
Synthesiser, Graphics Tablets, Light Pen etc.

ALTOS £2,389

Expands with your business.
Z80, 32 or 64K RAM Single User, 0.5 to
2Mb 8" Shugart Drives, CP/M Operating
System.

Multi-user to 4 users under MP/M or OMNIX
with 208K RAM.

Languages: MBASIC, CBASIC, COBOL,
FORTRAN, PASCAL, CIS COBOL & PLI.

Winchester Drives 14.5 Mb - £2,450, 29.0Mb
£3,250.

Cartridge tape back up 17.5Mb - £2,400.

SUPERBRAIN £1,995

Twin Z80, 64K RAM, Integral VDU and Dual
Disk Drives, 320 or 740K; plus expansion.
CP/M Operating System.

Languages: MBasic, Cobol, Fortran, Pascal
APL (keyboard mod. available)
wide range of applications software.

WORD PROCESSOR. £3,995

SUPERBRAIN + QUME DAISYWHEEL
+ WORDSTAR.

which is probably the most powerful word
processing software available, compares
directly with other systems costing £7,000
plus.

LEASE OR PURCHASE

FROM £22 per week

Can also run accounts, payroll stock control
etc. **SAVE £500** on component prices
(limited offer)

COMPLETE BUSINESS SYSTEMS from £2,300

SOFTWARE: We supply packages and custom
written software.

MAINTENANCE & SUPPORT: We provide
maintenance of both **HARDWARE &
SOFTWARE.**

PERIPHERALS: Anadex, Teletype, Commodore,
Texas 810, Qume, Adds, Lear Siegler etc.

SUNDRIES: Paper, Cassettes, Disks, Ribbons etc.

SHEFFIELD

COMPUTER CENTRE

Alan G. Williams-Morgan C.Eng, B.Sc (Hons),
M.Inst.E. Dr. Leslie Phillips D.Sc., Ph.D.

Kenneth Jones B.Sc. (Hons) Chris Mooney

MICROCOMPUTERS
MICROPROCESSORS
SOFTWARE
SERVICING
SALES & CONSULTANCY

Contact the professionals at:- 225, ABBEYDALE ROAD,
SHEFFIELD. S7 1FJ. Tel: 53519. Open Monday to Saturday
9a.m. to 5.30p.m. other times by appointment. 1½ miles from
City Centre on A621 Bakewell Road, 6 miles from M1

FREE ADVICE AND DEMONSTRATION.

Let our Requirements Analysis and after sales
SYSTEMS SUPPORT HOTLINE guide you onto, and keep
you on the path to prosperity.

Important for its uniformity

What is probably the most important single piece of software in the world of micros, CP/M, is used widely but, apparently, little understood. Peter Laurie details its functions and its significance.

CP/M STANDS for Control Program/Monitor and does roughly that for machines with 8080 or Z-80 processors and discs and now, 6502 CPU. It may seem strange that a disc-operating system should be so important but CP/M handles all the underlying accesses by the computer to the screen, the printer, the discs and the tape-reader or punch. In many ways, what appears to be the computer or the language at work in a CP/M system is actually CP/M itself.

What does a disc-operating system do? There are many available, usually something or other DOS. They are, of course, usually compatible only with a specific machine. There is no point trying to run a disc created under Apple DOS on a Tandy, or one from Cromemco on a Research Machines. So, what is special about CP/M? The answer is that wherever you find it, it acts, or should act, in exactly the same way.

In a world of many machines, CP/M imposes some welcome uniformity. Whatever the maker's name on the box, if your machine runs CP/M, it ought to run all CP/M software, providing the discs are formatted in the same way — the standard is 128byte, soft-sectored. From the commercial point of view that is extremely important.

Standardisation

Since CP/M is mounted on so many machines — some say that 75 percent of all micros with discs use it — it means that a large market exists already which can be serviced by the same software. When, as it is also said, there are 20 million small business systems in the world, CP/M will give access to a truly gigantic market.

The only other approach to uniformity is at machine level. The problem there for the independent software supplier is that he is at the mercy of the hardware manufacturer. New ROMs, new operating systems can suddenly destroy his market. CP/M is supported by so many manufacturers that this fate is most unlikely to overtake the software supplier who uses it.

CP/M is a large and complex piece of software which can be approached on at least three levels: the day-to-day user, the machine-code programmer who builds it into his programs, and the system builder who adapts it to run on his specific machine.

Let us look at the face it presents to the ordinary computer user. He switches-on the machine, inserts a disc into the drive and presses 'B' for boot. A piece of firmware in ROM runs and loads the CP/M core into memory where it remains while the computer is running.

The user can now load a high-level language or a program and go to work on whatever he wants, or he can make use of the various utilities CP/M offers directly. The program in core will respond immediately to five commands:

DIR — the most used, names the files held on a named disc.

ERA — erases named files. If you want to be rid of a series of files, like PICT1.BAS, PICT2.BAS, you can say: ERA PICT?.BAS. If you have a series like FRED.TXT, FRED.REL, FRED.PRN, FRED.COM — the debris from an assembler session, you can say ERA FRED.* to dispose of them all.

REN — re-names a file n 'name'.

SAVE — copies n 256byte blocks of memory from location 100Hex on to disc and calls the file name.

TYPE — prints a named file on the screen, or on the printer if you do Ctrl P.

Access methods

CP/M thinks that any other command you type in is the name of a file which it will try to load and execute. It has some more programs on disc which you can access in this way:

STAT — reports the free space on a disc, or if you give it the name of a file, will report how many bytes it holds.

PIP — (peripheral interchange program) copies files from one place to another. You can use it to merge several files together, or, more often, to copy files from one disc to another for back-up or distribution.

CONFIG — sets-up printer type and speed to work with the printer you have.

MOVCPM — re-adjusts CP/M for your memory size.

SYSGEN — creates CP/M on a new disc. You have to PIP the utility programs, such as PIP itself, but you can often do that by saying PIP *.COM since they are all command files.

ASM — loads an 8080 assembler.

LOAD — creates an executable disc file.

DDT — loads and runs a debugger.

ED — loads the text editor.

So, CP/M gives considerable power over raw files — they can be moved, erased, loaded from memory, typed and measured. Familiarity with the system at that level is essential for anyone who uses a CP/M machine.

At the next level, CP/M offers a fairly simple, standard way of interfacing with screen, keyboard, discs, printer, ports and the rest of the outside world at machine-code level.

Broadly speaking, for machine code you load a control number which tells CP/M what you want to do in register C, and a character in A or an address in DE and jump to 5 Hex, the CP/M entry point in the base page. In this way, one can write to the screen, disc or printer and so on, without having to know anything about the internal organisation of the particular computer you are using.

Disc file access is neat. Each file has a file control block (FCB) in memory which is set when it is created. Blocks for existing files are loaded from disc when the machine boots; FCBs for files which are created during program execution are formed in memory and copied to disc when the file is CLOSED.

That scheme has good and bad points. The good one is that a CP/M file can consist of sectors spread all over the disc. The numbers of the sectors used by a file are held in the FCB, so it is very easy for CP/M to use disc space intelligently.

File A may be written on to sectors 9, 16, 26, 43. You erase it by erasing its FCB and those sectors become free, so file B, which is at sector 52, is written next on to sector 9 and so on. All this is, of course, transparent to the user. All we see is that there is no problem in erasing and re-arranging disc space.

The bad thing is that if you fail to close a file — either because of carelessness or because of something like power failure — you lose the data in it because you have lost the sector directory. The data is still there, of course, on the disc but it is very tricky to access it. It would be advantageous if CP/M copied the FCB to disc for every alteration.

Conclusions

- CP/M offers a real promise of substantial standardisation. That standardisation will create a big market and hence encourage some really useful software. A new version appeared last winter. It allows files to be write-protected in CP/M rather than a high-level program and gives some other, more sophisticated, file-handling facilities. Version 2 is compatible with earlier releases.
- A more interesting product is MP/M, a multiple-user system.
- However, since processors are now so cheap compared to peripherals, it seems unlikely that multiple use will go the way it did on mainframes, with many terminals attached to a single processor.
- Instead, it is much more likely that many complete microcomputers will be interfaced to a few expensive peripherals, MP/M may not enjoy the same success as CP/M. □

An eye to the future with computer vision

Judging from current trends, it seems that computer vision will play an increasingly major role in future robot-control systems. Mark Witkowski reports on the latest developments.

SIGHT IS the primary sense used by people for a multitude of tasks; the same is also becoming true of robots. Television cameras have been interfaced to computers for many years now. These and images from other sources such as digitised medical X-rays, biological slide preparations, satellite data, bubble-chamber photographs and others have shown that our own visual processes are far from trivial.

Vision offers many advantages over other types of robot senses. A picture can be acquired relatively quickly and unlike force or touch sensors, it leaves the work-piece undisturbed.

It offers many types of information about the scene viewed, recognition of objects and about their position and orientation. Vision can be used by a robot to search its environment for an object which is needed, to provide feedback to guide a manipulator or vehicle in some complex task.

Checks can be made to verify that a task is proceeding satisfactorily and that it is completed correctly. Furthermore, the data used is understood readily by the human user.

The essential problem in robot vision is to take a digitised image, which may be nearly 250,000 bytes of data and reduce it to something useful, such as: "it's a conrod, located at X and Y, with an orientation of theta degrees".

Clearly such a massive data transformation is going to proceed in several stages, the algorithm for each may be very complex. Usually picture data is a matrix of

numbers, each of which represents the brightness of the image at a particular point in the scene.

Robot images are seldom less than 64 by 64 in size. Below that, the image is degraded by the digitisation process, and is, usually limited to around 256 by 256

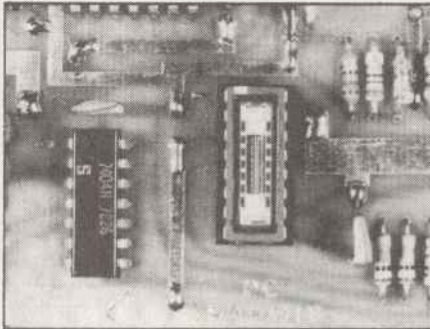

Picture 1.

due to the computation time required to process so much data.

Furthermore, each image point, or Pixel, will be digitised to a certain number of grey levels. That might be a simple binary image or one containing 256, 8 bits, different brightness levels. Imaging devices are usually solid-state photo-sensitive arrays of matrices, or standard Vidicon tube cameras.

Picture 1 shows a 64 x 1 photodiode array which are scanned using external clocking logic. The output from each light-sensitive diode is digitised and stored in computer memory in turn. Photodiode arrays up to 1,024 diodes in length are available.

They are particularly useful where the object to be viewed is essentially flat and moving, such as items on a conveyor belt. The CONSIGHT-1 system at General Motors is an example, figure 1 — Holland, Rossol and Ward, 1979.

Solid-state imaging matrices are manufactured both using photodiodes — the IPL 2D1 device is 64 by 64 diodes, manufacturer's literature, Integrated Photomatrix Ltd — and light-sensitive, charged coupled devices CCD.

The CCD201 is a 100 x 100 device — manufacturer's literature, Fairchild — which has been used in a number of robot projects. New solid-state units are being introduced and should soon be available in broadcast resolutions.

Solid-state cameras are smaller, lighter, consume less power and are more robust than their Vidicon counterparts. Some care is needed if they are to generate pictures with many grey levels — they are

prone to uneven sensitivity across the picture, though that can be corrected by compensating circuits — Green, 1980.

Drive circuits must be calibrated carefully if their full dynamic range is to be usable. As the photo-sensitive array is manufactured precisely, there is little distortion of the image. In high-resolution applications the linearity of scan in Vidicon-based cameras may be a problem.

Vidicon cameras are used where high resolutions are needed, from 256 x 256 to 1024 x 1024 Pixels, often to eight bits of grey level. Each digitisation of a 512-Pixel line from a standard 625-line television camera must be completed, including storing the resulting data in about 100 nanoseconds.

As that is considerably shorter than the cycle time of most mini-and micro-computers, the normal technique used is to store a single line of the picture, which is user-selected, in a fast buffer and later read into computer memory through a parallel interface or DMA device at a more leisurely rate.

Picture-frame capture-times vary considerably according to the hardware design and computer system used, but in every case the picture must remain stable

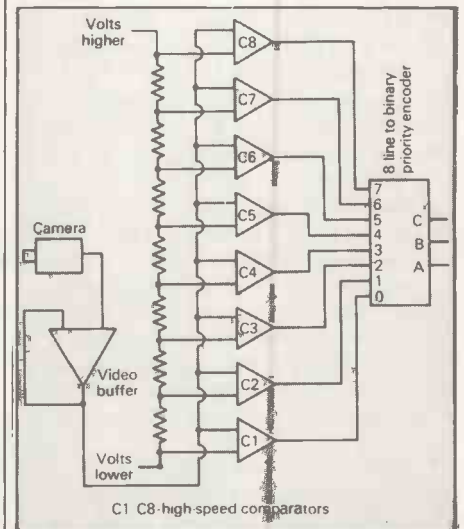
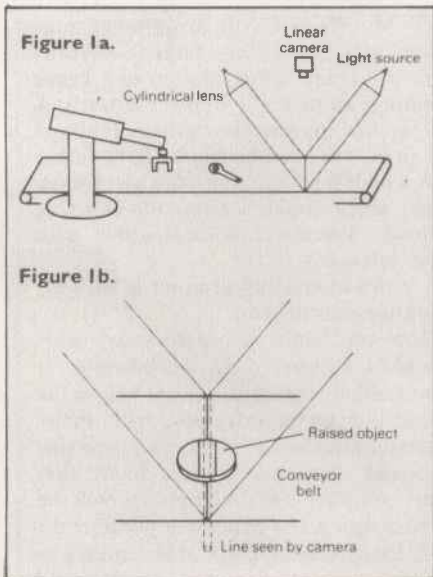

Figure 2.

during the whole of the acquisition phase. Picture-input times vary from four to 205 seconds for a 1024 x 1024 image — manufacturer's literature, Hamamatsu Ltd.

If rapid data capture is of prime importance, it is possible to digitise and store a complete picture in one frame-time, about 40mS, for later processing by a host

computer — manufacturer's literature, Microconsultants Ltd and Taylor, 1977.

Picture data signals represent a particular problem for analogue-to-digital conversion systems. The techniques mentioned in part three, ramp and successive approximation, are too slow. Figure 2 shows the principle of the fully-parallel flash 'a' to 'd' converter, capable of converting an analogue voltage into a binary number in less than 40 nanoseconds.

Each of the eight voltage comparators, C1 to C8, are fed with a different voltage from the resistor chain. The video waveform goes to the other input of all the comparators. None, some or all of the comparators will be active, according to whether the voltage at the resistor-divider chain input is greater or less than that of the video signal. The larger the video signal the more comparators will be switched on.

The outputs of all the comparators are

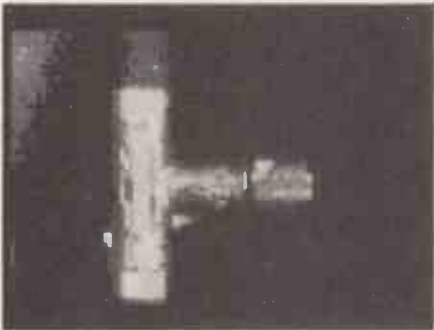

Picture 2.

fed to an eight-to-three-line (binary) priority encoder. The three-bit result shows the highest comparator to be switched on. Flash 'a' to 'd' converters are available in both module form, up to eight bit, 50nS conversion — manufacturer's literature, Date Ltd — in which the conversion takes place in two four-bit stages and as integrated circuits.

The chip contains the resistor chain, 255 comparators, a 255 to eight-bit priority encoder and latch — manufacturer's literature, TRW LSI products. A number commercially-available television-to-computer input systems are reviewed by Onda and Ohashi (1979).

Figure 3 shows a simple form of visual inspection which could be used to check castings and the like during manufacture. Only if all the uninverted photocells, C, D and E, are lit, and the inverted ones, A and B, dark, will the output indicate that the part is usable.

The casting has to be held in a precise position for the check to work — it is a simple form of template matching. Kirsch, 1979, describes how a laser beam is passed back and forth round an object, using mirrors to test it during manufacture.

Uno *et al.*, 1979, use template-matching techniques on the output of a CCD image to attach water hoses to test water pumps during manufacture. Hale and Sarago,

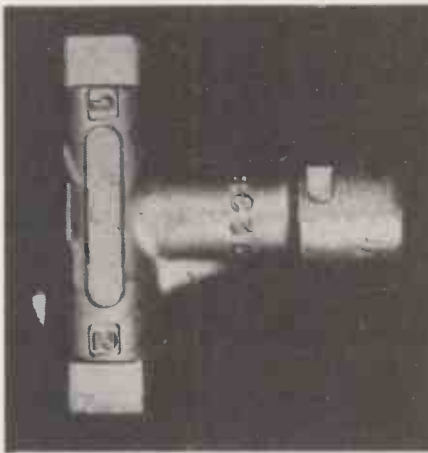

Picture 3.

1975, used a template-matching process to align printed-circuit lead pads ready for automatic drilling.

Template matching works only if the object is very nearly aligned with the sensor. Different techniques are required to locate and identify work-pieces.

Picture 2 shows a brass blank during manufacture, digitised using a 100-by-100 CCD solid-state camera. The output is digitised to four bits with a flash 'a' to 'd' converter. In the system, used pairs of four-bit Pixel values are stored in a single eight-bit byte of an 8K memory block on a 6800 microprocessor.

The memory block is isolated from the processor bus logically for the frame duration — about 20 mS — while the picture is loaded into a 5K portion of the memory. When frame capture is complete, the picture appears in the micro-computer memory space with no interruption of processing. Picture 3 shows the original item.

Only a few industrial robot systems use any grey-level information. The picture is pre-processed so that a binary image is formed. If the light intensity of any Pixel is less than a certain threshold, it is taken to be dark, otherwise it is taken as light.

A silhouette image is formed in which useful information about the object and any hole in it is contained in the size and shape of its overall outline. Obviously, great care must be taken with the lighting of the object. Shadows on the background or badly-lit recesses in the object could change the apparent shape of the image completely.

Picture 4 illustrates the potential prob-

lem with silhouette algorithms. The image is a section of a hexagonal nut, the background clearly dark and the nut light. However, the Pixels on the boundary are various shades of grey, caused, for the most part, by light from both the light and dark regions falling on the same photo-sensitive element and being averaged together.

If the binary threshold is, therefore, set high, many of these grey points will become black and the area and perimeter of the object will appear to shrink. Similarly, if it is set low, they will be taken as white and the object expand.

Great care is, therefore, needed for the lighting and camera aperture settings which should remain constant during and between sessions. Camera calibration may also involve showing the system grey step cards to determine the threshold point. There are also software calibration

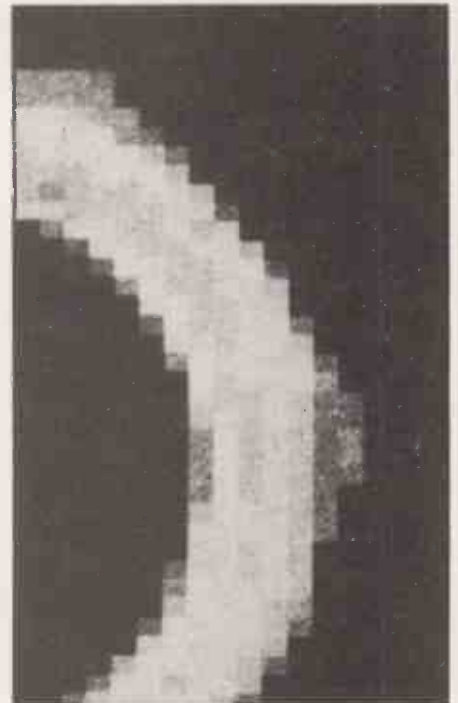

Picture 4.

techniques using histograms of the grey levels to determine the settings needed.

Several industrial robot systems, or at least prototypes, process binary images. Saraga and Skoyles, 1976, have a system to sort small objects delivered in a random orientation from a bowl feeder, to be picked-up by a three-degree-of-freedom

Figure 3.

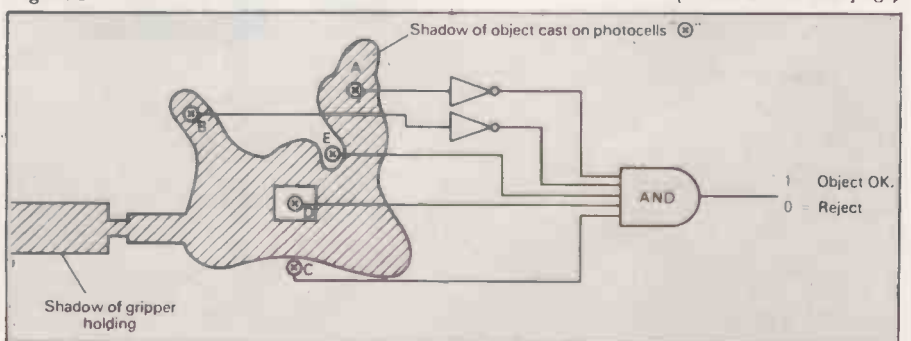

(continued on next page)

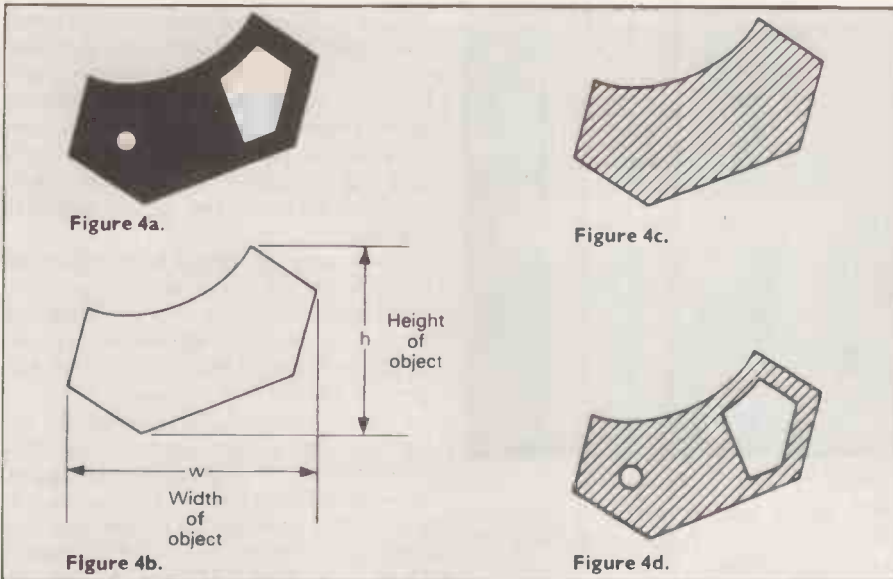

(continued from previous page)

arm and deposited correctly in a sorted hopper.

As the arm is designed only to pick objects at one particular point, the table can be rotated and translated in X and Y to position objects correctly. There are two cameras, one directly overhead and one to give a horizontal side-view of the object.

To give a clear binary image, the object can be lit from underneath, eliminating shadowing problems and spurious effects caused by highly-reflective objects.

SRI has developed a system for partially assembling car air-conditioning compressors using visual feedback to control a Unimate 2000B manipulator, McGhie and Hill, 1978. The task chosen was to view a compressor body from above against a black background, illuminated so that the flat top surface appeared bright, but that holes in it formed shadows and appeared dark.

The position and orientation of the compressor body was computed from two large, circular blobs — the holes forming the piston bores. A matching compressor cover was then located on the body and vision was again used to find the bolt holes.

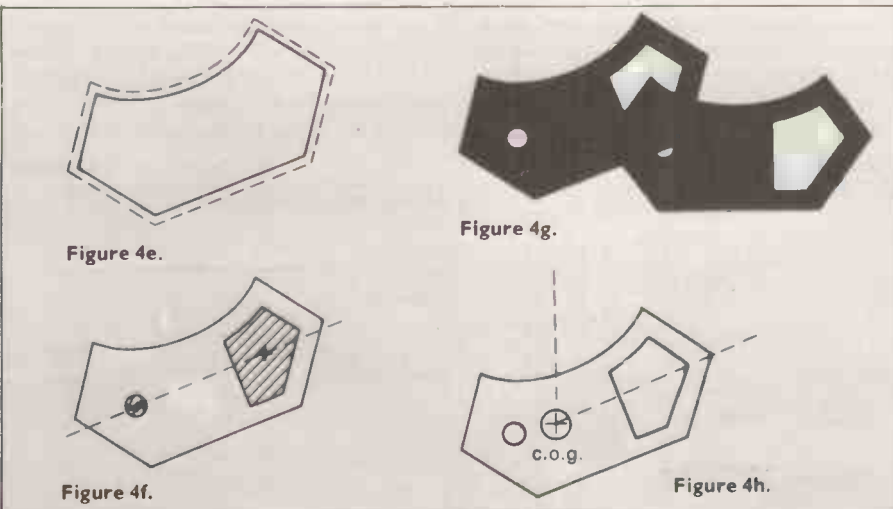

A third system to use binary images was Freddy, part of whose algorithm was described in part five. Freddy had to isolate a part from a heap, recognise it and place it in a standard position so that it could later be used by an assembly program.

The output of the linear scanning device

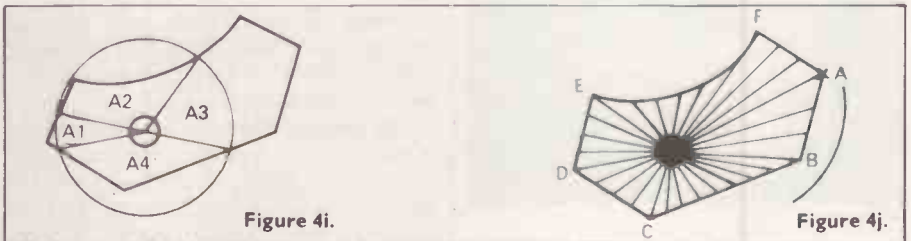

on CONSIGHT-1 was also limited to a binary signal. The designers of the system were very conscious of the problem of visual noise introduced by the grease, dirt and other debris to be found in a typical industrial environment.

Figure 1b shows the lighting arrangement they adopted for use with objects of a reasonable thickness on a conveyor belt. Their research dealt with such components as car engine connecting rods and universal joint yokes.

When the conveyor was empty, the array saw the bright line of light. When-

ever an object was illuminated, it would appear, from above, that the light beam was deflected to one side, out of the camera's field of view.

In fact, two projectors had to be used to prevent shadows, since the object first intercepts the beam but is not yet directly under the camera. A full binary image of the object was obtained by continually scanning as it was drawn through the field of view. Needless to say, that requires a good deal of housekeeping on the image.

There are a relatively small number of data extraction processes applicable to silhouette images and which are used to provide sufficient information to allow the program to identify the object from a set of possible objects and stable positions. To locate it accurately in terms of X and Y co-ordinates, or to identify sub-parts of it for detailed assembly see figure 4.

Assuming that the position and zoom settings of the camera remain unaltered and are calibrated, the area of the silhouette is a useful measure in identifying the part, figures 4c and 4d. That is extracted easily as the number of Pixels within the boundary of the image.

A second measure of the image is the

length of the perimeter of the shape, obtained by counting the Pixels round the edge — figure 4c. The ratio area to perimeter length is a measure of the complexity of the shape of the object. For a given area, the greater the perimeter, the more convoluted it must be. The compressor assembly program used a measure called 'PEROUND', defined as:

$$\frac{(4 \cdot \pi \cdot \text{TOTALAREA})}{(\text{PERIMETER} \cdot \text{PERIMETER})}$$

which returns one for a circular blob, less for more complex outlines — figure 4f.

Within the overall outline of the compressor body there were several dark blobs. All the interesting ones, bolt holes, cover aligning stud holes and the piston bores, were circular. They were isolated from other shapes of holes in the casting using peround, and then identified by their total area; the bores were the largest and the boltholes the smallest.

Once a circle is identified, its centre is found and the information is used to guide the manipulator. While bolts were screwed into the boltholes, force feedback sensors monitored the progress and a final visual check confirmed that the hole had been filled with a bolt and was now invisible.

In general, those measures work and in a reasonable time. It is generally assumed that if a computer-vision system for an industrial robot can reliably perform its

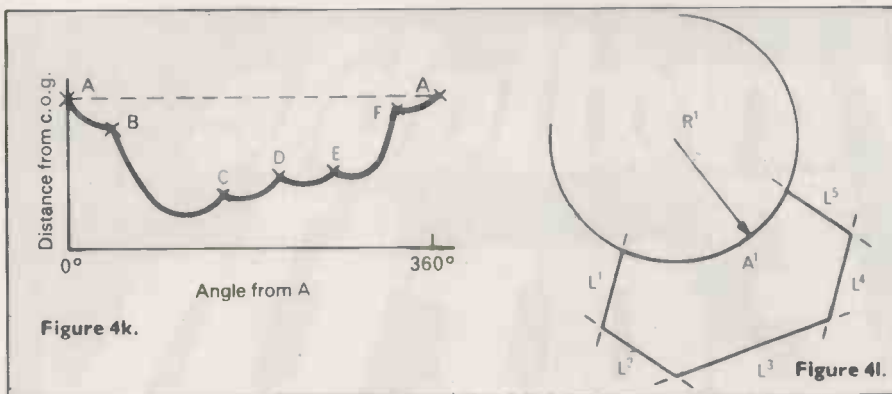

Figure 4k.

Figure 4l.

computation in a matter of seconds, it will be effective without making the manipulator wait for its instructions.

Those times are possible with current low-cost computers, and the algorithms are available as hardware/software packages — C1064, C1285, manufacturer's literature, Hamamatsu Ltd.

As more objects are added to the working set and the number and size of the differences between them becomes correspondingly smaller, so ever-more detailed features and differences have to be used to distinguish them. Figure 4l shows how the circumference of the shape can be represented as straight lines and arcs of circles.

Object orientation is a similar problem. If there are obvious features, such as the bore holes in the compressor body, their centres can be used to compute the information, i.e., figure 4f. Failing that, the centre of gravity of the image is evaluated — the point at which it would balance, if it were cut from a sheet of

object thousands of times a second. The device was used for feature tracking in both reconnaissance satellites and homing missiles. Kulpa, 1978, discusses possible problems to be encountered with calcul-

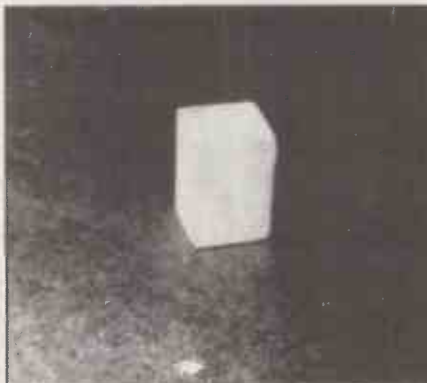

Picture 6.

ations for the centre-of-gravity method.

Perkins at General Motors, Perkins 1977 and 1978, used grey-level images, 256×256 to five bits from which the edges of the objects were extracted, resulting in a picture similar to a line drawing of the parts.

He then fitted a set of concurves to the line images, so that they were made from short line segments and arcs of circles. These relatively-organised descriptions could be compared to ideal descriptions of all the parts it might be.

As more of the features match between the current image and the stored model, the greater chance that the part will be identified correctly. As long as the match is above a certain confidence level, the process can stop.

So for most components only a portion of the object need be visible. In this way, where parts overlap or are only partially within the field of view, data from the model can supply the missing information.

Typically, it would be folly to try to attempt to isolate suitable features for recognition and use with an industrial robot 'by-hand'. After an initial calibration phase, during which the cameras are aligned and grey levels set, etc., the system is shown workpieces in typical orientations and stable states.

As each part is presented, the system runs through each of the parameter-extracting routines and builds-up its model of the parts. That process may be

guided by the user if he feels some feature or property of the object to be particularly significant. When that is done, the manipulator can be programmed to use the information from the vision system to complete the task.

Three-dimensional vision, as is required by mobile robots, is an altogether stickier problem. Even after more than 12 years of intensive research by hundreds of people, an elegant, and computationally-fast solution to the problem remains elusive.

The techniques described for processing silhouette images are inadequate. Once an image is made binary, about half of the objects merge into the background, or with each other and become totally invisible. As the vehicle moves round, the apparent shape of all the objects changes, so simple model-matching will not work either.

One possible starting point is to extract all the lines that bound various objects in the scene. As an illustration, picture 5 and 6 show a small wooden block and the result of digitisation to eight bits.

One algorithm which might be applied is the first difference between each Pixel and its neighbours — picture 7. At each boundary, the accumulated difference will be high and if it above a specified threshold, the Pixel is printed black.

Such an operator is far from ideal — low-contrast lines, or ones which change over a relatively broad front, shadows, for example, are lost easily. Small random discontinuities and grey-level perturbations in the image are favoured strongly and noise can be a significant problem.

Unfortunately, as the threshold is lowered to capture more of the lines, still more noise is introduced. To combat those problems, operators which detect lines locally have been introduced. Picture 8 shows the effect of the Walsh operator, proposed by O'Gorman, 1976. In general,

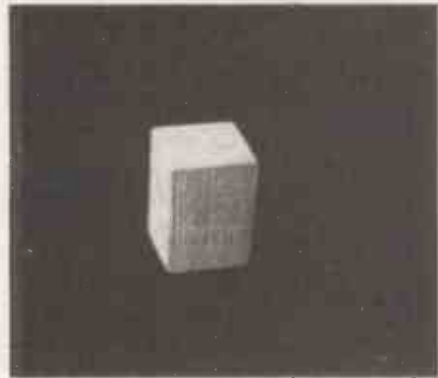

Picture 5.

metal. Figure 4h shows that by calculating the longest line to the edge, the orientation may be found.

Figure 4h is an alternative computation if this result were ambiguous — the ratios of A1 to A4 may also be used as a recognition measure. Saraga and Skoyles, 1976, discuss some criteria for choosing the size of the circle. Figure 4j extends these principles by computing many values from centre to edge and plotting them as an angular displacement graph — figure 4k. Martini and Nehr, 1979, cover the technique in more detail.

Dreyfus, 1974, describes hardware capable of scanning the outline of an

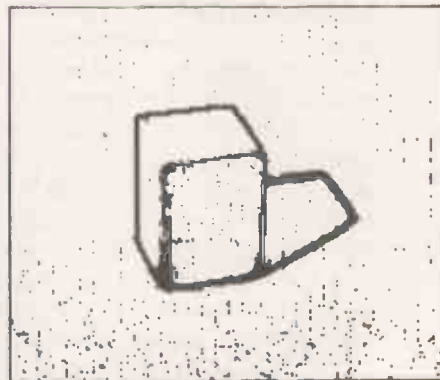

Picture 7.

the results are more manageable and freer from noise.

Hueckel, Hueckel, 1977, proposed a different operator, used by Perkins, but which is more expensive computationally. As none of the methods can be relied on to give perfect line drawings of the scene, various methods are employed to compute where the lines should be.

(continued on page 95)

Now available On Earth

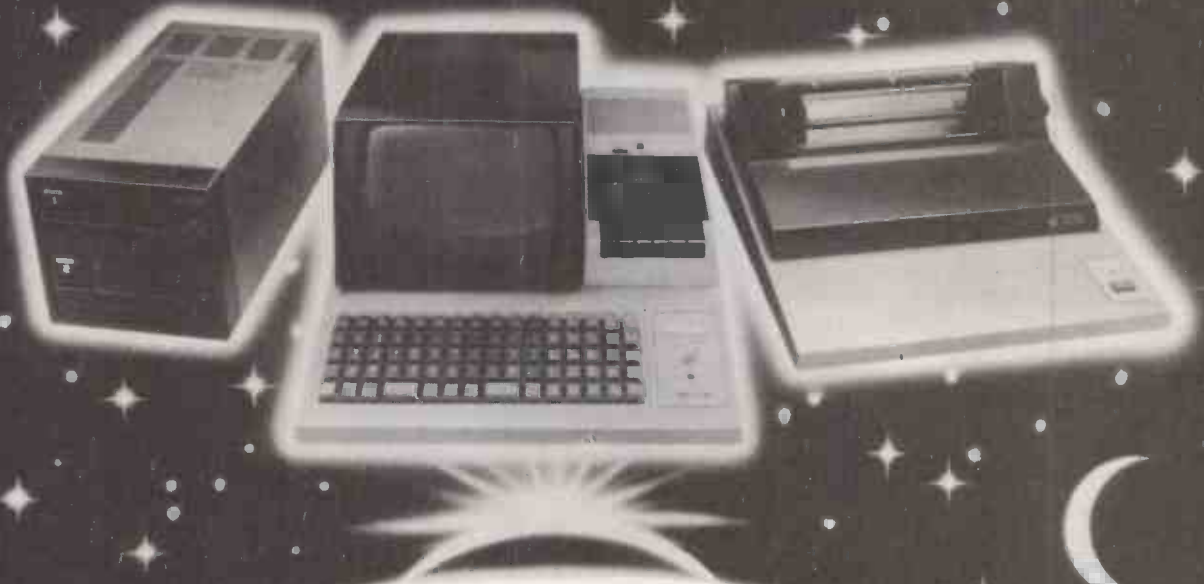

THE SHARP MZ-80 COMPUTER SYSTEM

Sharp have been associated with many major advances in electronic technology in space and here on Earth. We have introduced the most sophisticated production techniques for electronic circuitry to set world renowned standards of reliability into every product.

That's why the MZ-80K and its range of peripherals is going to change the way you think about microcomputers. The Sharp MZ-80 System now includes the MZ-80K processor backed with the MZ-80FD dual drive, double sided mini-floppy disk unit to give rapid, effective, sequential and random access, to huge amounts of stored information with incredibly fast response times.

Our new MZ-80P3 printer makes a good impression as well. Its fine definition dot matrix

head prints across 80 columns, at 100 characters per second, with full graphics capabilities.

The Sharp MZ-80 System is a new approach to computer applications, and their efficient use by human beings.

Our aim is to make computers and their related equipment relatively simple and therefore better understood and better used by those they are designed to serve.

Whether you are looking for a business system, or a system for educational or personal use—take a look at Sharp, it will change the way you think about computers.



COMPUTER APPLICATIONS

Send me details of the complete Sharp MZ-80 System and the name and address of my nearest stockist PC/7

Name _____

Address _____

Sharp Electronics (UK) Limited, Sharp House, Thorp Road, Newton Heath, Manchester. M10 9BE Tel: 061-205 2333

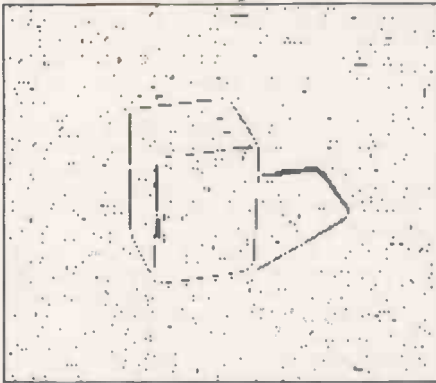

Picture 8.

(continued from page 93)

It is interesting to note that those programs seldom reconstruct the lines where a person would. A great many algorithms for analysing and post-processing images digitally are covered by Rosenfeld and Kak, 1976.

Once a scene has been reduced to a line drawing, a number of classic systems have been devised, such as those by Roberts, Waltz and Guzman — reviewed by Winston, 1972, or most books on artificial intelligence, e.g., Boden, 1977. Those systems variously separate, fit models to and identify parallel-piped, blocks-world, objects within the image.

Such programs are based on the observations that lines constituting such objects form readily identifiable patterns where they join and cross. They infer the three-dimensional structure from a two-dimensional picture because the surfaces of the objects are constrained to meet in well-defined ways.

Those algorithms do not extend easily

Picture 10.

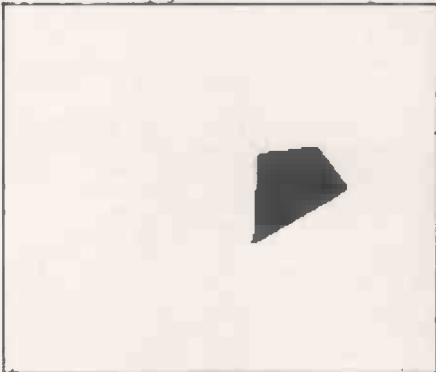

Picture 11.

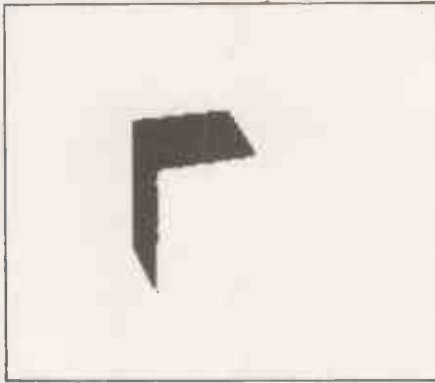
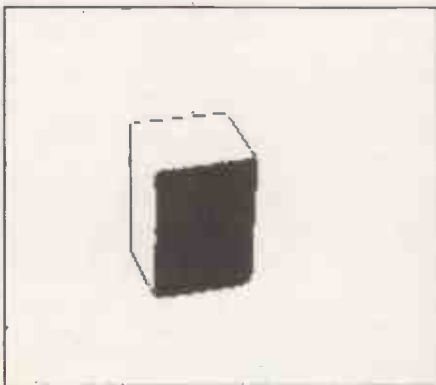

Picture 9.

to scenes containing objects with curved or irregular surfaces which are those of most interest to the robot user.

Perhaps a more fruitful approach is to

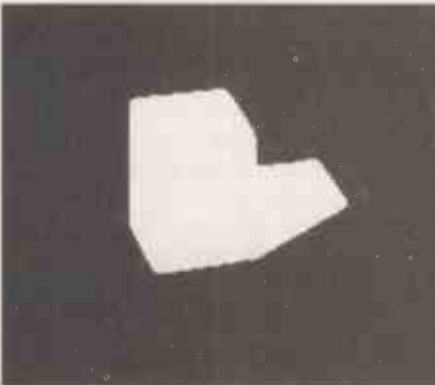

Picture 14.

attempt to isolate the regions in the image which correspond to the surfaces in the original scene, rather than to try directly to isolate the boundaries between them as

Picture 12.

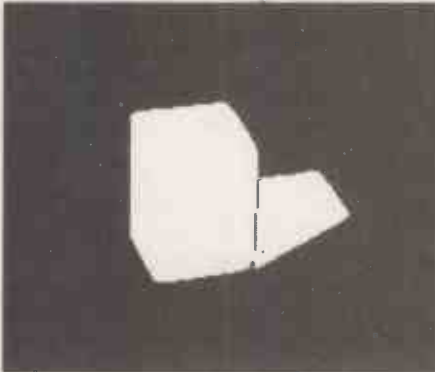

Picture 13.

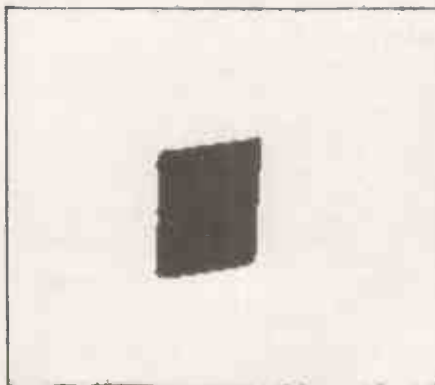

lines. Pictures 9, 10, 11 and 12 show a region segmentation of the image in picture 6.

In this case, a histogram of the grey value of every Pixel is formed on the assumption that each region will have a similar brightness — figure 5. The regions are then extracted as the major peaks in the histogram. Pictures 13 and 14 show the result of a simple but effective noise-removal program to tidy spurious parts of the image.

The histogram obviously works well when there are only a few peaks in separate places. As the scene contains more surfaces, so the grey-level histogram peaks will start to overlap and the segmentation becomes less reliable.

Surfaces with heavy-texture markings may also be segmented in a less-than-

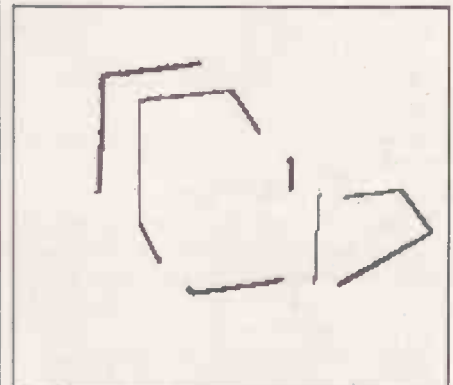

Picture 15.

desirable manner. However, once the regions have been isolated, a good line extraction is made easily.

Picture 15 is an exploded composite obtained by expanding each of the regions by one Pixel round its perimeter and then ANDing it with each of its similarly-expanded neighbours; the boundaries clearly show where they overlap.

Brice and Fennema, 1970, isolated objects in Shakey's world using a region-extraction algorithm but as their model matching was limited to cubic- and prismic-shaped objects, the data produced may have been less than ideal.

In response to an earlier problem, image segmentation can be made on texture measures; Pixels are part of a uniform texture belonging to the same surface, Skalansky, 1978.

Tenenbaum, 1973, proposed a system to analyse pictures of an SRI office using colour and range information. From the range data it is possible to compute the orientation of surfaces, although small errors in range lead to gross shifts in apparent orientation.

The scene could be analysed using that data and knowledge about SRI offices. For instance, the floor is to be found at the bottom of the picture, horizontal and with a specifically-coloured carpet. Desks rest on the floor, have a different height and colour; telephones sit on desks, are black and so on.

(continued on next page)



Figure 5.

(continued from previous page)

Shirai, 1978, used edge cues and models which could be transformed to fit images within real-world scenes, such as a desktop. All those vision systems detect and catalogue features of the objects within the scenes they analyse; the area, shape, colour, texture and corners are all identifiable. Features can be complex structures, with lesser features of their own, a telephone may be identified by its dial, a ring of 10 ellipses, within a larger ellipse.

Some or all of those different modalities can and should be used by a vision program, the danger being that the program will grow to exceed the machine and that the time it takes will increase from seconds to minutes, to hours.

All those systems use static information, The mobile robot is, however, able to move and capture another view of the same objects to resolve any difficulties. By projecting light beams into the scene,

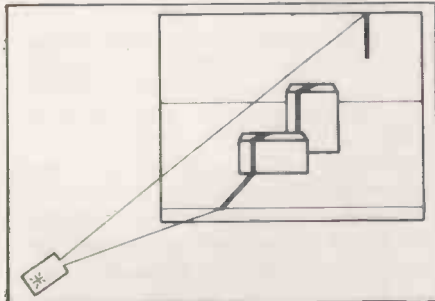

Figure 6a.

information may be obtained that is difficult to infer from conventional two-dimensional images.

Figure 6a shows the effect of projecting a thin sheet of light vertically into a scene, from the camera's point of view. As the light penetrates more deeply into the scene, it appears further and further to the

right of the image. Figure 6b shows a plan view of the arrangement.

Knowing the relative positions and angles of the light strip projector and camera and the lenses focal length, it is

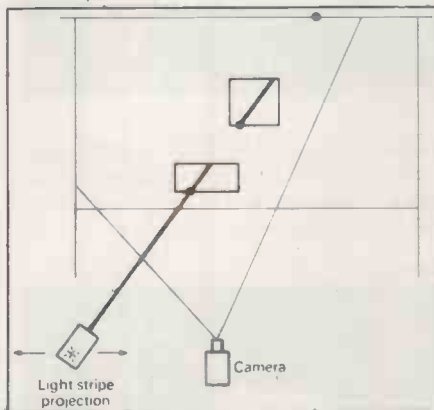

Figure 6b.

easy to compute the depth of any point illuminated by the strip. If the projector is then moved to the left and right it is possible to build-up a complete depth-map of the scene — Pöppelstone *et al.*, 1975, and Agin, 1979.

Philip Marks, has demonstrated the real-time advantages of processing images using currently-available parallel processors — Marks, 1980.

References

- Agin G J (1979). *Real-time robot control with a mobile camera*. Robotics Today, Autumn, 1979, pp. 35-39.
- Boden M A (1977). *Artificial intelligence and natural man*. An Open University set book. Hassoeks. The Harvester Press. ISBN 0-85527-435-2.
- Brice C R and Fennema C L (1970). *Scene analysis using regions*. Artificial Intelligence 1-3 Autumn, 1970, pp. 205-226.
- Dreyfus M G (1974). *Visual robots*. The Industrial Robot 1-6, December 1974, pp. 260-264.
- Green D K (1980). *Improving photodiode camera signals*. Wireless World 86-1532, April, 1980, pp. 85-88.

Hale J A G and Saraga P (1975). *Control of a PCB drilling machine by visual feedback*. Advance papers of 4th International Joint Conference on Artificial Intelligence. (IJCAI) held at: Tbilisi, Georgia, USSR, September 3-8, 1975. pp. 775-781.

Holland S W, Rossol L and Ward M R (1979). *Consight-1: A vision-controlled robot system for transferring parts from belt-conveyors*. Computer vision- and sensor-based robots. New York: Plenum Press. ISBN 0-306-40305-6. pp. 81-100.

Hueckel M H (1977). *An operator which locates edges in digitised pictures*. Journal of the Association of Computing Machines, Vol. 18, pp. 113-125, January 1971.

Kirsch J (1979). *Progression of intelligence in limited sequence robots*. Industrial robots vol. 2. Tanner W R ed., Michigan: Society of Manufacturing Engineers. ISBN 0-87263-046-3. pp. 277-284.

Kulpa Z (1978). *Errors in objects positioning with centre-of-gravity method*. The Industrial Robot 5-2, June 1978, pp. 94-99.

Marks P C (1980). *Low-level vision using an array processor*. Computer Graphics and Image Processing.

Martini P and Nehr G (1979). *Recognition of angular orientation of objects with the help of optical sensors*. The Industrial Robot 6-2, June 1979, pp. 62-69.

McGhie D and Hill J W (1978). *Vision-controlled sub-assembly station*. Robots III conference at Chicago, Illinois, November 7-9, 1978. (SRI report).

O'Gorman F (1976). *Edge detection using Walsh functions*. Conference proceedings of ATSB Summer Conference, July 12-14, 1976. University of Edinburgh: Dept of A I, pp. 195-206.

Onda H and Ohashi Y (1979). *Introduction of visual equipment to inspection*. The Industrial Robot 6-3, September 1979, pp. 131-135.

Perkins W A (1977). *Model-based vision system for scenes containing multiple parts*. General Motors Research Laboratories Research Publication GMR-2386.

Perkins W A (1978). *A model-based vision system for industrial parts*. IEEE Transactions on Computers, vol. C-27-2, February 1978, pp. 126-143.

Pöppelstone R J, Brown C M, Ambler A P and Crawford G F (1975). *Forming models of plane-and-cylinder faceted bodies from light strips*. Advance papers of 4th. IJCAI. pp. 664-668.

Rosenfeld A and Kak A C (1976). *Digital picture processing*. London and New York: Academic Press. ISBN 0-12-597360-8.

Saraga P and Skoyles D R (1976). *An experimental visually-controlled pick-and-place machine for industry*. 3rd. Int. Joint Conf. on Pattern Recognition. Held: Coronado U.S.A. November 8-11 1976. pp. 17-21.

Shirai Y (1978). *Recognition of real-world objects using edge cue*. Computer vision systems, Hanson A R and Riseman E M eds. ISBN 0-12-323550-2. pp. 353-362. London and New York: Academic Press.

Skalansky J (1978). *Image segmentation and feature extraction*. IEEE Transactions on systems, man, and cybernetics. Vol. SMC-8, 4, April 1978. pp. 237-247.

Taylor R (1977). *New approach to image processing*. Systems International, February 1977, pp. 33-35.

Tenenbaum J M (1973). *On locating objects by their distinguishing features in multi-sensory images*. Stanford Research Institute Artificial Intelligence Centre, Technical note 84, September 1973.

Uno T, Ikeda S, Ueda H, Ejiri M and Tokunaga T (1979). *An industrial eye that recognises hole positions in a water pump testing process*. Computer vision- and sensor-based robots. New York: Plenum Press.

Winston P H (1972). *The MIT robot*. Machine Intelligence 7, Meltzer B and Michie D. eds. pp. 431-463. Edinburgh University Press. ISBN 0-85224-234-4.

ACT THE ADVANCED DISK UNIT, It turns your Pet into a business system



Supports a wealth of Business Systems

Sales Ledger/Purchase Ledger

Powerful packages integrated to Nominal Ledger and Analysis.

Nominal Ledger

Up to 2,500 active postings a month; on-screen enquiries; month-end trial balance.

Analysis Package

Sales performance by territory; calculation of commissions; analysis of purchases.

Stock Control

Parameter driven; on-line enquiries; comprehensive range of reports.

Invoicing

Parameter driven; invoices tailored to user requirements; automatic typing.

Pagemate™ Database

Sophisticated report generating package; for work in progress, direct mail etc.

Wordcraft™ Simply the ultimate word processor for the PET.

+ A FULL RANGE OF PETSOFT PROGRAMS.
ALL AVAILABLE FROM ACT'S PET BUSINESS COLLECTION.

Advanced Disk Hardware

- 1 Ultra fast-loads and auto verifies a 32K program in 5 seconds from a cold start.
- 2 Up to 800 Kbytes on-line— dual density double sided.
- 3 Powerful Disk Operating System— 9 additional commands and 7 extra disk instructions to the PET's own Basic.
- 4 Compatible with 16K and 32K new ROM PETS.
- 5 Random and sequential file access and support.

- 6 Comprehensive manual and utility disk.
- 7 Languages—Microsoft Basic, 6502 Assembler. Forth. Fifth, Pilot and Cesil.

**400 Kbyte
Disk Unit £895.**

**800 Kbyte
Disk Unit
£1,145.**

PET is the trademark of Commodore. Prices exclude VAT and are correct at time of going to press.

ACT
MICROSYSTEMS

ACT (COMPUTERS) LTD.
Radclyffe House, 66-68 Hagley Road,
Edgbaston, Birmingham B16 8PF.
Tel: 021-455-8686. Telex: 339396.

ACT
TOTAL
COMPUTING

ACT (COMPUTERS) LTD. Radclyffe House, 66-68 Hagley Road, Edgbaston,
Birmingham B16 8PF. Tel: 021-455-8686. Telex: 339396

Please rush me details of: The advanced ACT disk unit.
 The PET business system collection. The Petsoft catalogue.

Name: _____
Company: _____
Address: _____
Tel. No.: _____

PC7

• Circle No. 173

COME AND SEE US AT THE
MICRO-COMPUTER SHOW
— STAND NO. 46

**TIME & COST
RECORDING
SYSTEM**
£300

**INCOMPLETE
RECORDS
ACCOUNTING
SYSTEM** £450

**SALES
LEDGER
SYSTEM**
£300

**PURCHASE
LEDGER
SYSTEM**
£300

Padmede Computer Services
Business Software for Apple/ITT 2020

**STOCK
CONTROL
SYSTEM**
£300

**INVOICING
SYSTEM**
£300

**INSURANCE
BROKER
SYSTEM**
£500

**JOB
COSTING
SYSTEM**
£300

**Padmede
Computer
Services**

112/116 HIGH STREET
ODIHAM
NR. BASINGSTOKE
HAMPSHIRE
Tel: Odiham (025-671) 2434

If you wish to buy any of the above systems, please complete the coupon below and return to: Padmede Computer Services, 112/116 High Street, Odiham, Nr. Basingstoke, Hants.

	Manuals & Sample Reports	£	✓ Here if required	Apple/ITT Software	£	✓ Here if required
Padmede Purchase Ledger System		£5	<input type="checkbox"/>	£300		<input type="checkbox"/>
Padmede Sales Ledger System		£5	<input type="checkbox"/>	£300		<input type="checkbox"/>
Padmede Incomplete Records Accounting System		£5	<input type="checkbox"/>	£450		<input type="checkbox"/>
Padmede Invoicing System		£5	<input type="checkbox"/>	£300		<input type="checkbox"/>
Padmede Job Costing System		£5	<input type="checkbox"/>	£300		<input type="checkbox"/>
Padmede Time & Cost Recording System		£5	<input type="checkbox"/>	£300		<input type="checkbox"/>
Padmede Stock Control System		£5	<input type="checkbox"/>	£300		<input type="checkbox"/>
Padmede Insurance Broker System		£5	<input type="checkbox"/>	£500		<input type="checkbox"/>
Software Sampler		£10	<input type="checkbox"/>			<input type="checkbox"/>
	Total	_____		Total	_____	
	Zero VAT	_____		+ 15% VAT	_____	

Grand Total Cheque enclosed Total _____

Name _____

Address _____

DEALER ENQUIRIES WELCOME PC/7/80



1980
MICRO-COMPUTER
SHOW

Wembley

Conference Centre
July 22-24 1980

exhibition guide

compiled

by

**Practical
Computing**

E1

online

ONLINE CONFERENCES LIMITED · ARGYLE HOUSE · JOEL STREET
NORTHWOOD HILLS · HA6 1TS · MIDDLESEX

AT LAST!

Appleware

The best of
British and American
**APPLE
SOFTWARE**

ACT Appleware brings you 70 classic programs from the worlds leading suppliers of Apple software. Many have already become best sellers in America. So send today for a free copy of the most exciting Apple software catalogue ever. We promise

to keep you on the mailing list.

Appleware is backed by the resources of the ACT Group, Britains leading computing company. Contributing software houses include Programma International, Personal Software, Automated Simulations, Speakeasy Software and P.D.I.

Disk programs include:

Applepie Text Editor £30
Alien Invaders £8
Apple Database £23.50
Talking Disk (Speech Synthesis) £14.95
Apple FORTH £39.95
Assembler/Editor (in machine code) £45

Try them at your Apple Dealer. Also available by mail order direct from ACT Appleware.



Send a free catalogue to

Name

Address

Post code

I have an Apple II ITT2020
 No Apple

Appleware

Radcliffe House, 66/68 Hagley Road, Edgbaston, Birmingham B16 8PF
Telephone 021-455 8585 Telex 339396

exhibition guide

1980 MICRO-COMPUTER SHOW

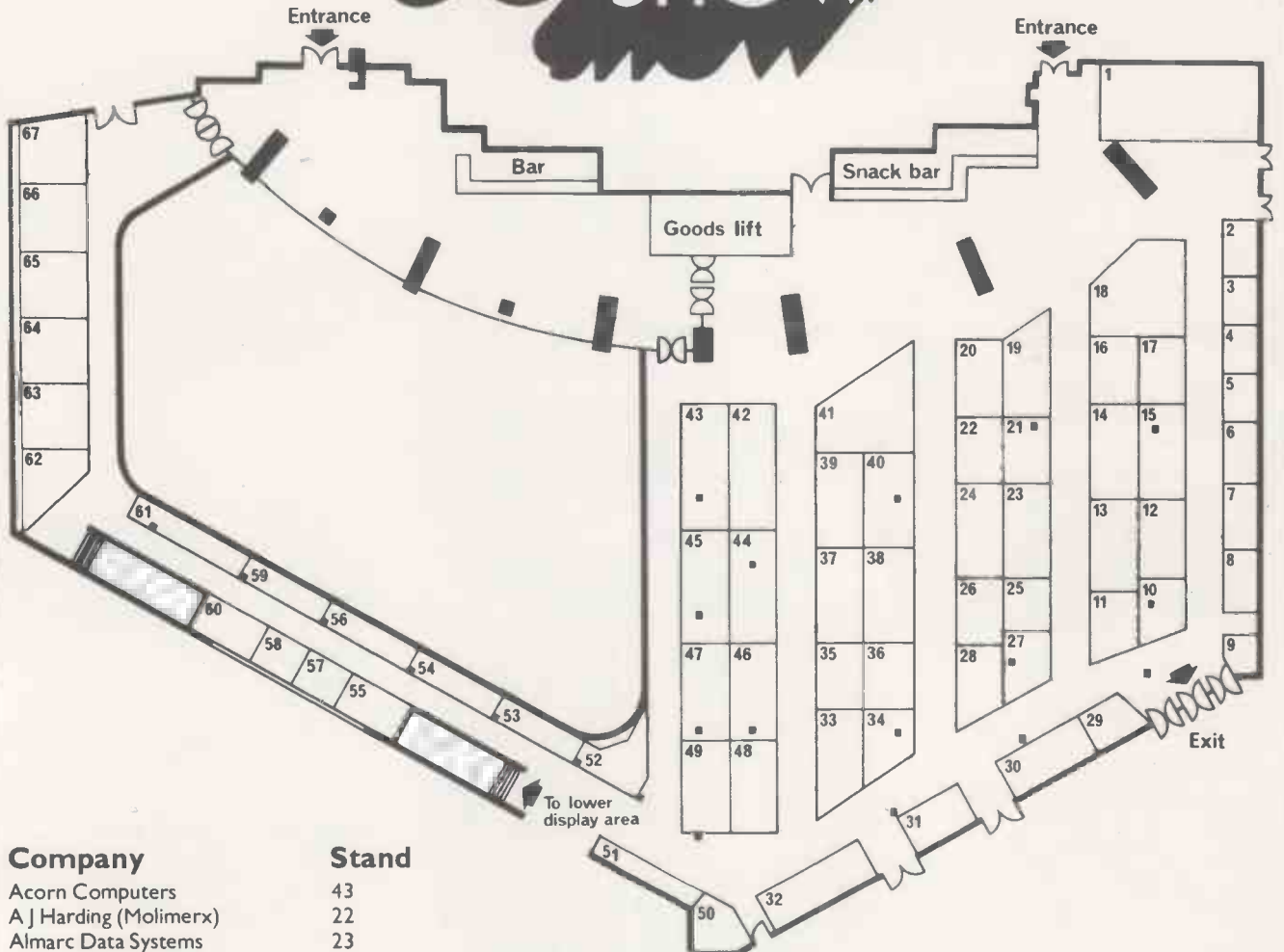

Company

Acorn Computers	43
A J Harding (Molimerx)	22
Almarc Data Systems	23
American Data Inc	67
Audiogenic	58
BMG Microsystems	13
Clenlo Computing Systems	66
Comart	18
Commodore Business Machines	53, 54, 56 & 59
Compshop	41
Computabits	55
Computer Age	63
The Computer Bookshop	52
Department of Industry	44
Dillon's University Bookshop	20
Dyad Developments	61
ECC Publications	12
Equinox Computer Systems	38
Euro-Calc	42
Ferranti Computer Systems	24
Harvey Fabrication	60
Hayden Book Company	65

Stand

Company

H B Computers	2 - 8
James Scott Electronic Developments	28
Katanna Management Services	10
Keen Computers	14/16
Logitek	39
Mannesman Tally	62
Micro '80 Publications Centre	1a
MicroAct	46b
Microbyte	57
Michael Gurr Associates	29
Microsolve Computer Services	26
Midwich Computer Company	19
Newbury Laboratories	32
Online Conferences	1b

Company

Company	Stand
Padmede Computer Services	46a
Personal Computers	33
Personal Computer World	34
Practical Computing	25
Product Launch	30
Quality Systems International	60
Research Machines	17
Rostronics	45
Sigma U.K.	15
Sirton Computers	11
Systematics International	40
The Software House	49
Tandy Corporation	47
Tangerine Computer Systems	27
Telefusion	37
Total Concept Systems	9
Transam Computers	31
Walters Microsystems	35

ALTOS

In essence, the best in integrated circuit technology

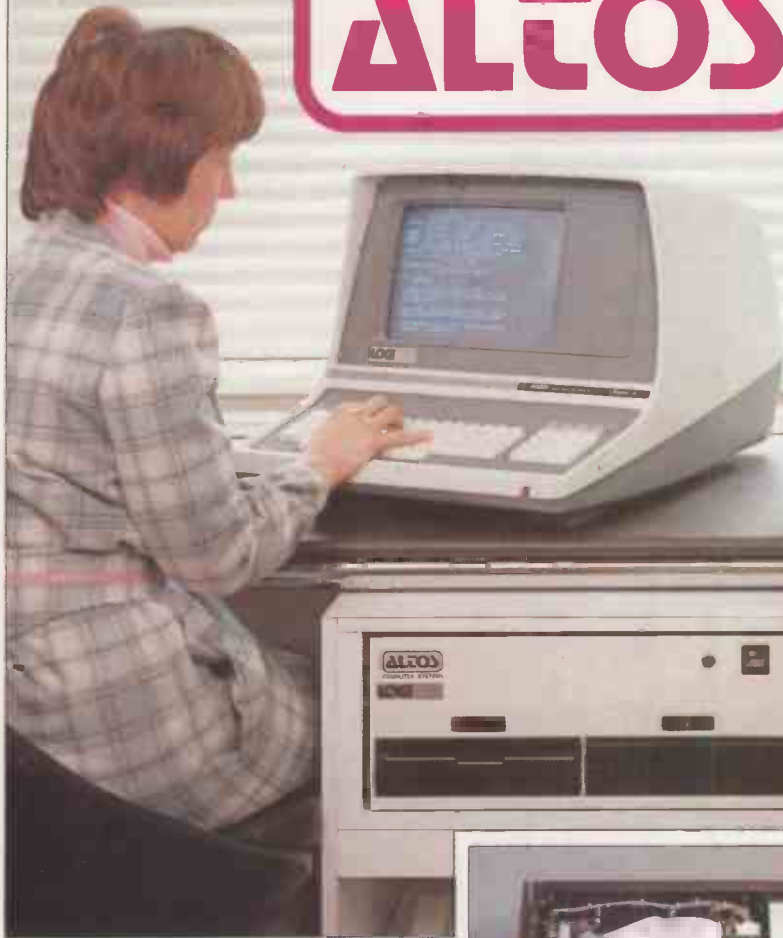

The ALTOS ACS 8000 range of business/scientific micro computers creates a new standard in quality and reliability in high technology micro computers.

High Technology

Floppy Disk System The ACS 8000 single board Z80 floppy disk based micro computer utilises the ultra reliable Shugart 8 inch, IBM compatible, disc drives, double density — single sided, and providing 1 M. byte of data storage. Featuring the ultimate in high technology hardware: a fast 4 MHz.Z80CPU, 65 kilobytes of 16 K dynamic RAM, 1 kilobyte of 2708 EPROM, an AMD 9511 floating point processor (OPTIONAL) a Western Digital floppy disc controller, a Z80 direct memory access (OPTIONAL), Z80 parallel and serial I/O (two serial RS232 ports, 1 parallel port) and a Z80 CTC Programmable Counter/Timer (real time clock). In essence, the best in integrated circuit technology.

Hard Disk/Multi User Systems

The Winchester hard disk/multi user systems are now available supporting up to 4 simultaneous users and providing a maximum of 58 Megabytes of hard disk data storage.

The systems are truly flexible and allow expansion of the ALTOS floppy disk system to keep pace with the users requirements.



Still single board, features include
* a high speed I/O section with up to six serial ports and one 8 bit Parallel port
* up to 208K of on board RAM.
* High speed (4 MHz.) D.M.A. control as standard.

Yes, mIni power and at micro cost too.

Built-in Reliability

The ACS 8000 range are true single board micro computers making them extremely reliable and maintainable. All electronics are socketed for quick replacement. Complete diagnostic utility software for drives and memory is provided.

The board and Shugart floppy disk drives are easily accessible and can be removed in less than ten minutes.

Quality Software

Unlimited versatility. The ACS 8000 range support the widely accepted CP/M and MP/M operating systems plus basic (Microsoft and CBasic), Cobol, Pascal, and Fortran IV. All available now.

Logitek in conjunction with its own microsoftware house, Interface Software Ltd. of Camberley are able to supply a wide range of proven 'off the shelf' business software including general accounting, word processing, stock control, mailing list etc.

There are already over 1000 micro computer installations using this software. A track record which we consider speaks for itself. Why 're-invent the wheel' when there is standard software of this quality available now?

After Sales Support

Logitek are supported by DDT Maintenance Ltd. who provide a nationwide field maintenance service for ALTOS products and offer the option of maintenance contracts.

Availability

Logitek carry deep shelf stocks of ALTOS hardware and compatible peripherals.

If you are a dealer who may be interested in promoting ALTOS and/or Interface Software by joining the fast growing network of approved suppliers, contact Logitek.

We can offer you something rather special now.

LOGITEK

LOGITEK, E.I.C. Electronics Ltd. All enquiries to: Portland St. Chorley, Lancs. Tel: 02572 66803
also at: 30 Kelvin Ave., Hillington Industrial Estate, Glasgow G52 4LH.

Logitek are now the exclusive distributors of Altos Computer Products for the U.K. & Eire.

THERE'S A WORLD OF DIFFERENCE In Business Software!

Get the most out of your microcomputer Graham-Dorian's Integrated, On-Line Programs Are Fast, Efficient, And Easy To Use.

At any given time, your hardware is only as useful as the software you run in it. Our programs let you realize the full potential of your hardware.

Graham-Dorian provides highly detailed and well documented programs. All pre-tested on the job. Each so comprehensive that it takes little time to learn to run a program — even for someone who's never operated a computer before.

Graham-Dorian programs are on-line now working for us and others around the world. They are ready to go to work immediately or to be tailored for your more specific needs. Each package contains a software program in BAS and INT file form plus a user's manual and hard copy SOURCE LISTING.

Programs are compatible with most major computers using CP/M disk operating systems, and come in standard 8" or on various mini-floppy disks.

Graham-Dorian stand behind dealers with technical advice.

Yes, there's a world of difference in business software. Graham-Dorian has more per-package capabilities and more packages (with new ones added every few months).

The Graham-Dorian line now includes these packages

- Nominal Ledger
- Purchase Ledger
- Sales Ledger
- Job Costing
- Order Entry & Invoicing
- Payroll
- Manufacturing Inventory
- Manufacturing Job Costing
- Wholesaler Inventory
- Retailer Inventory
- Cash Register
- Apartment
- Surveying
- Dental

CBASIC-2

Ask your dealer* for a demonstration soon.



+ GDSS are appointing UK Dealers and European Distributors. Enquiries and applications invited.

* CBASIC-2 is a trade mark (copyright 1980) of Compiler Systems, Inc. GDSS are the European Distributor for CBASIC-2.

Graham-Dorian Software Services

17 The Gallop, Yateley

Camberley, Surrey.

Tel: (0252) 874790

(0344) 51160

ES

International Conference and Exhibition

Tuesday, July 22. 10.00 hrs. - 18.00 hrs.

Wednesday, July 23. 10.00 hrs. - 18.00 hrs.

Thursday, July 24. 10.00 hrs. - 17.00 hrs.

The event is organised by Online Conferences Ltd and comprises a three-day exhibition, a two-day international conference and four full-day seminars covering important aspects in the development and use of microprocessors. Full details and late registration forms can be obtained at the conference reception desk. Admission to the exhibition is by ticket only. The admission fee at the door is £1.50 (incl. of VAT).

Conference and Seminars

Microelectronic Applications

July 22-23

This twin-stream international conference will examine the present development of microelectronics, both in manufacturing and in the rather controversial area of data processing.

Microprocessors in Industry

Tuesday, July 22

This seminar sets out to discuss in straightforward terms the various ways that large and small companies can take advantage of this new technology.

Microsystems in Business

Wednesday, July 23

The main theme of this seminar is to acquaint the first-

time user with the opportunities and pitfalls of installing a microsystem.

Microcomputers in Education

Thursday, July 24

Participants will have the opportunity to hear experienced teachers and advisors express and demonstrate what they feel to be the importance of computers in schools.

Future Computing

Thursday, July 24

A full-day seminar presented by Dr Portia Isaacson and Dr Egil Juliussen of the U.S.A., with the emphasis on technology forecasts, small computing, microprocessors and distributed processing.

List of exhibitors

Acorn Computers

4a Market Hill, Cambridge, Cambs.

Tel: 0223 50262

Sales contact: Chris Curry

Stand 43

ON THE stand is the new Acorn Atom ready-cased with a complete full-size QWERTY keyboard. It can be plugged into a black and white television to give a VDU 16 lines by 32 characters. It can be altered for graphics modes ranging in resolution to a high resolution which is 256 × 192. This VDU uses 6K of RAM a normal VDU uses ½K.

Space for 12K RAM on board of which 6K is used for the screen leaving 8K for the program case. The Acorn Atom also comes with 32K of ROM which contains a full integer Basic using 32-bit integers. There is also a 2K assembler using standard 6502 mnemonics.

A J Harding (Molimerx)

28 Collington Avenue,

Bexhill-on-Sea, East Sussex.

Tel: 0424 220391 Telex: 86736

Sales contact: John Harding

Stand 22

THE company specialises in the supply of software for TRS-80, Models I and II. Staff of Harding Molimerx on stand 22 will demonstrate any of its software. Of particular interest this year are Microsoft utilities including new editor/assembler,

together with a new structured Basic assembler.

Customers may purchase software at stand 22 together with accessories such as diskettes, tapes and the well-known Green Screen. Also on display is a new book by Hubert S Howe on machine language programming and contents of ROM and RAM.

Almarc Data Systems

906 Woodborough Road, Nottingham.

Sales contact: David Swain

Stand 23

ALMARC Data Systems, now main U.K. agents for the full-range of Vector Graphic Systems, will be exhibiting: Full business packages including word-processing systems — prices from £5,490. The Vector System "B" at £3,195. The Vector System 2800, a twin eight in. floppy drive system, IBM-format drives with a total formatted capacity of 2.4Mbytes. Price from £4,195. The Vector System 3030, a 32Mbytes hard disc system. Price from £7,500. An industrial-control system utilising the powerful Vector System B.

All systems include, in the price, a standard software package consisting of CP/M2 operating system, Microsoft Basic 80, Scope — a 250-column line editor written specially for the Vector Mindless Terminal and Flashwriter II Board.

American Data Home & Office Computer

150 Regent Street, Suite 500,
Chesham House, London W1R 5FA.

42 Avenue Monterey,

Luxembourg City, Luxembourg.

Tel: 01-499 7033 London

352 231 72 Luxembourg

Sales contact: Barbra Hall

Stand 67

ON display a full range of Ohio Scientific microcomputers from the single-board Superboard II to hard disc systems.

Audiogenic

34-36 Crown Street,

Reading, Berkshire RG1 2SN.

Tel: 0734 595647

Stand 58

AUDIOGENIC Ltd manufactures the complete range of Petpack Software for Commodore Systems and has been appointed by Commodore as its exclusive mail order dealer. The company has developed an advanced quality control procedure which utilises Pet computers.

As the makers, Audiogenic is able to keep at its offices constant stocks of all the products. That means, of course, that software can normally be dispatched on the same day as the order is received. Where cheques are used rather than one of the credit cards, a few days should be allowed for bank clearance.

BMG Microsystems Ltd

Micro House, Hawksworth,
Swindon, Wiltshire, SN2 1DZ
Tel: Swindon (0793) 37813
Telex: 449634

Stand 13

BMG Microsystems is exhibiting its expandable, attractively-designed MS5000 range of business computers. Elegant desk unit incorporates Intel 8085A microprocessor with 64K RAM, Intel Multibus, a high-quality tilt/swivel display, detachable keyboard, 1MB floppy disc, 10MB fixed disc, 10MB demountable hard discs and 160cps printer — other printers are available. Multiple displays may be attached. System provides for easy upgrade. Intel 8086 16-bit microprocessor and larger disc capacities will be available later this year.

BMG is a distributor of standard software including CP/M and MP/M and Microfocus CIS Cobol, plus a wide range of other compilers. Application software includes production-control/shop-scheduling package.

Cleno Computing Systems

15 Southview Court, The Woodlands,
Beulah Hill, London SE19 3EJ.

Tel: 01-653 6028

Sales contact: J L Harris

Stand 66

CLENLO Computing Systems is a south-London-based firm specialising in all aspects of hardware and software for microcomputer business and organisational applications. Its hardware product range is centred round an S-100-based microcomputer which allows the adoption of a wide variety of options by the end-user, ranging from no disc facilities at all, through mini and full-size floppy disc drives up to four 26Mbyte hard discs.

On the software side, it is U.K. distributor for the first application generator package to be made available on Z-80 and similar-based microcomputers. The package is called PEARL and runs under the widely-used CP/M operating system.

Comart

PO Box 2, St. Neots, Huntingdon.

Tel: 0480 215005

Stand 18

COMART is announcing and launching major new products at the 1980 Micro-computer Show. A multi-user operating system supporting up to seven users extends the facilities of the powerful Cromemco Z-2H hard disc system and maximises the storage of the diskette-based Systems 2 and 3. The Cromemco product range is further enhanced by an extremely high-resolution colour graphics hardware and software package demonstrated publically for the first time in Europe.

Comart is also launching the North Star 18Mbyte Winchester disc Horizon system

and will be demonstrating the new North Star word-processing, mailing and information database applications software.

Commodore Business Machines

818 Leigh Road Trading Estate,
Slough, Berkshire.

Tel: Slough (0753) 74111

Telex: 848403

Sales contact: Andrew Goltz

Stands 53, 54, 56 & 59

DURING the 1980s, every small- and medium-size company will be able to afford its own computer system. The acquisition of a comprehensive micro-computer system from Commodore, consisting of a compact and versatile Pet microcomputer, incorporating its own VDU unit, together with a dual floppy disc drive and needle matrix printer, no longer represents a capital investment nor a disruption to work in the office.

The Commodore business computer, with a selection of powerful, yet easy-to-operate business packages, takes on a multitude of administrative tasks.

Compshop Ltd

14 Station Road,
New Barnet,

Herts., EN5 1QW.

Tel: 01-441 2922 (Sales)

Stand 41

COMPSHOP, Europe's largest discount personal computer shop, will be displaying probably the most comprehensive range of equipment at this year's show — everything from games to complete computer systems. The stand will feature the Radio Shack TRS-80 Model 2, running CP/M along with a number of other languages.

Compshop stocks large amounts of equipment which rarely run out and gives extended warranties on all products. Through Compucare, most makes of personal computers can be repaired and maintained.

The Computer Bookshop

Temple House, 43-48 New Street,
Birmingham B2 4LH.

Tel: 021 643 4577 Telex: 337045

Sales contact: Margaret Maclean

Stand 52

COMPUTER Bookshop is U.K. distributor for the Sybex Inc. The complete range of Sybex books including Programming Z-80 and Z-8000 is on display and for sale. Exhibited are approximately 200 other titles including a range of new books from Howard Sams who published 6502 Software Design Book, Osborne's Pet and IEEE 488 and Bus and the Pet Guide. Comprehensive catalogues are available on the stand and advice about your nearest microcomputer store.

Department of Industry (MAP)

Gaywood House,
29 Great Peter Street,
London, SW1 3LW.

Tel: 01-212 0690

Sales contact: G M Bowen-Jones

Stand 44

GOVERNMENT assistance is available under the Microprocessor Application Project (MAP) to encourage U.K. industry to apply microelectronic technology. Assistance of up to £2,000 is available under the MAPCOM scheme; this is towards the cost of employing consultants to carry out a feasibility study to identify microprocessor applications in a company's product or production processes and systems.

Other support is for actual projects involving microprocessors. This takes the form of either a grant up to 25 percent or qualifying costs, or a shared-cost contract under which the Government will contribute up to 50 percent of cost in return for a levy on resulting commercial sales.

Dillon's University Bookshop

1 Malet Street, London, WC1E 7JB.

Tel: 01-636 1577

Sales contact: Nigel Berkeley

Stand 20

ON DILLON'S stand there is a selection of books on minicomputers, microprocessors, and application of computer systems in business and research, also some fascinating material on impact of computers in society.

Only a fraction of vast stocks available in Dillon's Malet Street shop in London, where all publishers in this field are represented, are exhibited. If you cannot visit the shop, ask for book lists and order forms. Dillon's has an international mail order service backed by one of the widest selections of academic and technical books in the U.K.

Dyad Developments

The Priory, Great Milton, Oxon.

Tel: 08446 729

Sales contact: Gary Roberts

Stand 61

SEE the Compucolour II with its superb colour graphics. Systems are available for hands-on tests, with software packages including educational, statistical, soundware and games on display. Our staff will be available to answer any queries.

The Basic Compucolour system comprises a colour VDU with built-in disc drive. 16K or ROM-based Basic and DOS 8K, 16K or 32K or user RAM, plus many exciting features. As a special offer, we are offering a £100 discount on any systems ordered at the show. Any dealer enquiries welcome.

Britain's first computer kit.

The Sinclair ZX80.

£79.95

Price breakdown
 ZX80 and manual: £69.52
 VAT: £10.43
 Post and packing FREE

sinclair
ZX80

Please note: many kit makers quote VAT-exclusive prices.

You've seen the reviews... you've heard the excitement... now make the kit!

This is the ZX80. 'Personal Computer World' gave it 5 stars for 'excellent value.' Benchmark tests say it's faster than all previous personal computers. And the response from kit enthusiasts has been tremendous.

To help you appreciate its value, the price is shown above with and without VAT. This is so you can compare the ZX80 with competitive kits that don't appear with inclusive prices.

'Excellent value' indeed!

For just £79.95 (including VAT and p&p) you get everything you need to build a personal computer at home... PCB, with IC sockets for all ICs; case; leads for direct connection to a cassette recorder and television (black and white or colour); everything!

Yet the ZX80 really is a complete, powerful, full-facility computer, matching or surpassing other personal computers at several times the price.

The ZX80 is programmed in BASIC, and you can use it to do quite literally anything from playing chess to managing a business.

The ZX80 is pleasantly straightforward to assemble, using a fine-tipped soldering iron. It immediately proves what a good job you've done: connect it to your TV... link it to an appropriate power source... and you're ready to go.

Your ZX80 kit contains...

- Printed circuit board, with IC sockets for all ICs.
 - Complete components set, including all ICs - all manufactured by selected world-leading suppliers.
 - New rugged Sinclair keyboard, touch-sensitive, wipe-clean.
 - Ready-moulded case.
 - Leads and plugs for connection to domestic TV and cassette recorder. (Programs can be **SAVED** and **LOAD**ed on to a portable cassette recorder.)
 - FREE course in BASIC programming and user manual.
- Optional extras**
- Mains adaptor of 600 mA at 9 V DC nominal unregulated (available separately - see coupon).
 - Additional memory expansion boards allowing up to 16K bytes RAM. (Extra RAM chips also available - see coupon).

*Use a 600 mA at 9 V DC nominal unregulated mains adaptor. Available from Sinclair if desired (see coupon).

The unique and valuable components of the Sinclair ZX80.

The Sinclair ZX80 is not just another personal computer. Quite apart from its exceptionally low price, the ZX80 has two uniquely advanced components: the Sinclair BASIC Interpreter; and the Sinclair teach-yourself BASIC manual.

The unique Sinclair BASIC interpreter offers remarkable programming advantages:

- **Unique 'one-touch' key word entry: the ZX80 eliminates a great deal of tiresome typing. Key words (RUN, PRINT, LIST, etc.) have their own single-key entry.**
- Unique syntax check. Only lines with correct syntax are accepted into programs. A cursor identifies errors immediately. This prevents entry of long and complicated programs with faults only discovered when you try to run them.
- Excellent string-handling capability - takes up to 26 string variables of any length. All strings can undergo all relational tests (e.g. comparison). The ZX80 also has string input to request a line of text when necessary. Strings do not need to be dimensioned.
- Up to 26 single dimension arrays.
- FOR/NEXT loops nested up to 26.
- Variable names of any length.
- BASIC language also handles full Boolean arithmetic, conditional expressions, etc.
- Exceptionally powerful edit facilities, allows modification of existing program lines.
- Randomise function, useful for games and secret codes, as well as more serious applications.
- Timer under program control.
- PEEK and POKE enable entry of machine code instructions,USR causes jump to a user's machine language sub-routine.
- High-resolution graphics with 22 standard graphic symbols.
- All characters printable in reverse under program control.
- Lines of unlimited length.

Fewer chips, compact design, volume production - more power per pound!

The ZX80 owes its remarkable low price to its remarkable design: the whole system is packed on to fewer, newer, more powerful and advanced LSI chips. A single SUPER ROM for instance, contains the BASIC interpreter, the character set, operating system, and monitor. And the ZX80's 1K byte RAM is roughly equivalent to 4K bytes in a conventional computer - typically storing 100 lines of BASIC. (Key words occupy only a single byte.)

The display shows 32 characters by 24 lines. And Benchmark tests show that the ZX80 is faster than all other personal computers.

No other personal computer offers this unique combination of high capability and low price.

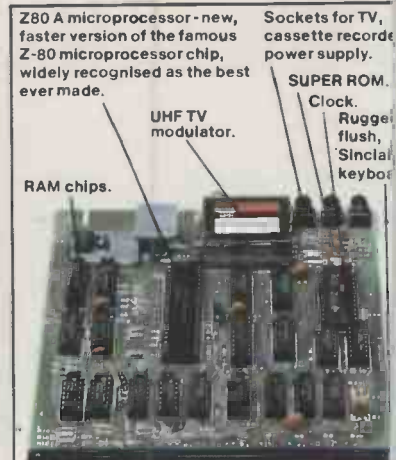

plete

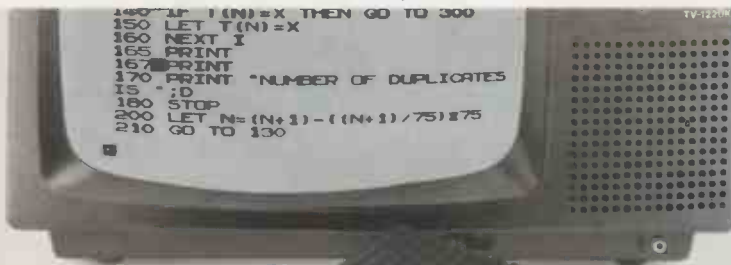

The Sinclair teach-yourself BASIC manual.

If the specifications of the Sinclair ZX80 mean little to you - don't worry. They're all explained in the specially-written 128-page book free with every kit! The book makes learning easy, exciting and enjoyable, and represents a complete course in BASIC programming - from first principles to complex programs. (Available separately - purchase price refunded if you buy a ZX80 later.) A hardware manual is also included with every kit.

The Sinclair ZX80. Kit: £79.95. Assembled: £99.95. Complete!

The ZX80 kit costs a mere £79.95. Can't wait to have a ZX80 up and running? No problem! It's also available, ready assembled, for only £99.95.

Demand for the ZX80 is very high: use the coupon to order today for the earliest possible delivery. All orders will be despatched in strict rotation. We'll acknowledge each order by return, and tell you exactly when your ZX80 will be delivered. If you choose not to wait, you can cancel your order immediately, and your money will be refunded at once. Again, of course, you may return your ZX80 as received within 14 days for a full refund. We want you to be satisfied beyond all doubt - and we have no doubt that you will be.

sinclair ZX80

Science of Cambridge Ltd

6 Kings Parade, Cambridge, Cambs., CB2 1SN.
Tel: 0223 311488.

ORDER FORM

To: Science of Cambridge Ltd, 6 Kings Parade, Cambridge, Cambs., CB2 1SN.
Remember: all prices shown include VAT, postage and packing. No hidden extras.
Please send me:

Quantity	Item	Item price £	Total £
	Sinclair ZX80 Personal Computer kit(s). Price includes ZX80 BASIC manual, excludes mains adaptor.	£79.95	
	Ready-assembled Sinclair ZX80 Personal Computer(s). Price includes ZX80 BASIC manual, excludes mains adaptor.	£99.95	
	Mains Adaptor(s) (600 mA at 9 V DC nominal unregulated).	8.95	
	Memory Expansion Board(s) (each one takes up to 3K bytes).	12.00	
	RAM Memory chips - standard 1K bytes capacity	16.00	
	Sinclair ZX80 Manual(s) (manual free with every ZX80 kit or ready-made computer).	5.00	

NB. Your Sinclair ZX80 may qualify as a business expense.

TOTAL £

I enclose a cheque/postal order payable to Science of Cambridge Ltd for £ _____

Please print

Name: Mr/Mrs/Miss _____

Address _____

PC7

ECC Publications

30-31 Islington Green, London, N1 8BJ.
Tel: 01-359 7481

Sales contact: Cathy Lane

Stand 12

THE MAGAZINE for all business computer buyers and users, WHICH COMPUTER?, offers unprejudiced opinions on many categories of computer equipment and thoroughly-researched assessment of individual systems. WHICH WORD PROCESSOR? — published as an occasional supplement to WHICH COMPUTER? — serves as an update on the latest developments in the word processing market.

Educational Computing — everything about using computers in schools, colleges and universities to keep them in touch with each other and with the industry. *Computer Guides*, three volumes giving a complete overview of small business systems, word processors, and production-control systems.

Equinox Computer Systems

Kleeman House, 16 Anning Street,
New Inn Yard, London EC2.

Tel: 01-739 2387

Sales contact: Mike Kusmirak

Stand 38

EQUINOX Computer Systems, one of the leading U.K. and most-established micro-system suppliers is exhibiting its multi-user, multi-tasking systems offering a choice between MVT/FAMOS, OMNIX + CAP MicroCobol. The system is based on the Equinox cartridge disc drive and Series 8000 desktop or desk microcomputer which is supplied with two or three 8-in. floppy disc drives, a high-speed printer and VDU/keyboard.

The cartridge drive has 5MB of removable cartridge and 5MB of fixed platter which eliminates the need to provide separate data back-up. The removable disc allows for fast back-up and, therefore, unlimited off-line storage.

Ferranti Computer Systems Ltd

20 Denmark Street,
Wokingham, Berkshire.

Tel: 0734 790079 Telex: 8438367

Sales contact: D E Stone

Stand 24

FERRANTI is showing the latest version of the F100-L 16-bit microcomputer. A single desk-mounted module contains a complete microcomputer system including two double-density floppy disc drives. Only four cards are necessary to provide a Coral 66 high-level language compilation facility. The remaining eight slots are available for additional printed circuit cards from standard F100 range, which has now been expanded to include D/A and A/D converters, enabling a complete process-control system to be configured using the F100-K microcomputer. In

addition to its general-purpose role, F100-L microcomputer is also used to provide resident program generation facilities to support the F100-L microprocessor.

Harvey Fabrication Ltd — Special Products

Woolwich Road, London, SE7 7RJ.

Tel: 01-858 3232 Telex: 896648 APW.

Sales contact: D A Bevan

Stand 60

ENCLOSURES for electronics, computer and instrument industries, produced in rigid polyurethane without the necessity for expensive hard tooling. Enclosures finished to customers' choice, with the ability to supply in any colour. Surface finish and colour are produced direct from the mould giving a very hard and durable coloured enclosure moulding. The process requires a Master Model from which a prototype or small-to-medium production run of up to 2,500 units can be produced.

Hayden Book Company

50 Essex Street, Rochell Park,

New Jersey, 07662 U.S.A.

Tel: 010 1 201 843 0550

Sales contact: Alan Bonds

Stand 65

THE 1980s will be the microcomputer decade, and no one publisher will be able to meet the needs of this decade better than the Hayden Book Company Inc. Why? Because, on the one hand, we are the number one publisher of microcomputing books. Practical and informative books, written by experts, covering the gamut from introductory material through specific advanced material. On the other hand, we have already gained the reputation of being a quality software publisher. Software compatible with the TRS-80, Apple II, Pet, Sorcerer, and Heathkit, and Hayden will offer software for other micros in the future.

H B Computers Ltd

22 Newland Street,
Kettering, Northamptonshire.

Tel: 0536 83922/520910

Telex: 341297

Sales contact: Colin Stanley

Stands 2 - 8

H B COMPUTERS is showing a range of computer hardware starting in price at around £500 for Sharp MZ80K computer to CBM professional systems and upward to ACT 800/824 systems. It aims to show microcomputers and software to suit all applications and pockets.

Apart from the highly-successful H B sales, purchase and nominal packages, there is also fully-integrated Nebula business software package from ACT, and other business application packages. Media and consumables are featured, prominent among this section being the BASF range of supplies for which H B is a

distributor, confirming the position of H B as leading suppliers of hardware, software, media and consumables suppliers.

James Scott Electronic Developments

William Press Group,

28 Essex Street, WC2R 3AY.

Tel: 01-353 6544 Telex: 887832

Sales contact: Martin Underwood

Stand 28

JAMES SCOTT Electronic Developments manufactures and markets the Lyme Peripherals range — including 4000 series, which features instant local recall of up to 26 lines, 72 characters per line and a 12 × 7 character dot matrix. An additional feature, within range, is capability to emulate DECVT2 and Data General Dasher 6053. James Scott Electronic Developments is backed by extensive production facilities of James Scott Manufacturing Division and is part of engineering group, William Press.

Katanna Management Services

22 Roughtons, Galleywood,
Chelmsford, Essex.

Tel: 0245 76127

Sales contact: Antoinette Dean

Stand 10

KATANNA specialises in complete systems either in ready-prepared packages or individually-written programs for most sizes of microcomputer. On show is the Tandy TRS-80 microcomputer, with packages for the following: stock control, payroll, sales ledger, purchase ledger, nominal ledger and word processing.

Keen Computers Ltd

5 The Poultry,

Market Square, Nottingham.

Tel: 0602 583254

Sales contact: Tim Keen

Stand 14/16

ON SHOW at the Keen stand will be the very latest technology to help you to solve your problems plus the very best personnel to advise you. The following products are to be displayed for the first time by KCL. The Corvus Constellation. The ultimate in mass storage for your micro. Share up to 40MB of hard disc between up to 64 computers. You can have Apples, Pets, TRS-80s, LSI-11s, Northstars or any S-100 system. Ideal for business or scientific use. The Mirror. The most revolutionary back-up to Winchester hard disc yet devised. An interface to a video tape recorder. Now you can have over 300MB of tape storage. Transfer of 1MB per minute approximately.

CCS Interfaces. California Computer Systems, one of the fastest growing interface manufacturers in the world, is releasing a number of new interfaces for Apple, S-100 and Pet computers.

Logitek

Portmand Street, Chorley, PL7 1SF.
Tel: 02572 55803 Telex: 677354
Sales contact: Jim Pickup

Stand 39

ALTOS ACS 8000 new generation single-board microcomputer demonstrates a comprehensive multi-user business system with 14.5Mbytes of hard disc storage. This system is supported by an off-the-shelf library of software packages, fully compatible for U.K. and European business applications.

Library is updated continually and extended with a capacity for structuring programs for specific requirements. The Altos unit with its advanced software capability has already attracted designers involved in research, production and other control systems. Apart from reliability of its single-board technology, the unit has a built-in expansion capability of up to 58Mbytes storage on hard disc.

Mannesmann Tally

7 Crenyll Road, Reading RG1 8NQ.
Tel: 0734 580141
Sales contact: Bernard Lavell

Stand 62

M80MC: When personal computers are used on small business systems, the printer is often the weakest link. The M80MC is a well-engineered and reliable replacement which is much faster and only slightly more expensive. It is an 80-column microprocessor-controlled version of a well-proven machine, parallel interface compatible with all well-known personal computers and micros.

T1602: New models of this popular printer will be launched at the exhibition. In all its forms, it gives you optimised, bi-directional microprocessor-controlled printing at 160 cps.

T1612: Forty-two keyboard programmable functions makes the T1612 the most versatile 1200baud printer around.

M132MC: The M132MC microprocessor version of another well-tried printer gives exceptional print quality at 200 cps at a low price.

Michael Gurr Associates

140 High Street,
Tenterden, Kent TN30 6HT.
Tel: 05806 4278
Sales contact: Jon Gurr

Stand 29

APPLE Systems displayed include: Cameo disc — 5MB fixed/5MB removable; Sanders media printer and/or 1DS 440W/graphics; CCS Arithmetic processor, CIS Dealer Advertising software; CMA Teacher plus Apple Education software; Databases and software from: Syner-gistics, High Technology, CCA, Baclan,

Rainbow, SMI, Sensible Software, Computer Station, Mighty Byte Computer, Creative Discount Software and CIS; Keen Supercolor; Covercraft dust covers.

Micro '80 Publications Centre

Argyle House, Joel Street,
Northwood Hills, HA6 1TS.
Tel: 09274 28211

Stand 1a

THE Micro '80 Publications Centre will have a wide range of publishers of computer books represented. A central information desk will be manned at all times where publishers price lists, catalogues and order forms may be obtained. In some cases, publishers participating may arrange for one of their representatives to be present at certain times on the stand. Among publishers which will be attending are Online Publications, QED Information Sciences Inc U.S.A., Logica, Palace Publishing and Pitman's Publishing.

MicroAct Ltd

66/68 Hagley Road,
Edgbaston, Birmingham.
Tel: 021-455 8585

Stand 46b

PETSOFT and Appleware will be displaying and offering for sale the largest range of software and ancillary products for the Pet and Apple machines. See us at our stand and collect the latest exciting brochures.

Microbyte

Division of Maclin-Zand Electronics
38 Mount Pleasant,
London WC1X 0AP.
Tel: 01-278 7369/01-837 1165
Telex: 8953084
Sales contact: Neil Zand

Stand 57

MICROCHIPS at micro prices has been the Microbyte promise ever since the company started trading nearly two years ago. The aim was simple — fill a large gap in the market by offering a wide range of memories, CPUs and EPROMs at very competitive prices and mostly ex-stock. The demand for the company's products started in much the same way as the company has grown ever since — phenomenally, and today Microbyte is rapidly gaining a reputation for always being first to offer the new chips as they come off the production line, as well as a good range of books on microcomputers — also at micro prices, naturally.

Microsolve Computer Services Ltd

Middlesex House,
29/45 High Street, Edgware, Middx.
Tel: 01-951 0218/9/0
Sales contact: Stanton Smith

Stand 26

ON display is the Apple II computer system demonstrating business accounting systems and word processing. Lear Siegler 300 printer and Qume daisywheel printer are connected to the systems. Microstar multi-user microcomputer system with two VDUs and high-speed matrix printer is also on display. The system shows different accounting systems fully-integrated to make a complete business system. Alphamicro, probably the most powerful microcomputer available today. The system on display consists of a 10Mbyte hard disc system with two VDUs and printer. A fully-integrated accounting system is also on display.

Midwich Computer Company Ltd

9 Churchgate Street,
Old Harlow, Essex.
Tel: 0279 411226 Telex: 817035
Sales contact: D Watson

Stand 19

FULL range of Nanocomputers is on display including the newest addition, NBZ80HL. It is similar to the NBZ80 but includes a video interace, alpha-numeric keyboard and Microsoft Basic in ROM. A full range of Z-80 books and accessories are available for sale on stand 19 at special exhibition prices.

Newbury Laboratories

40 Bartholomew Street,
Newbury, Berkshire.
Tel: 0635 30505

Stand 32

THE EXISTING new Microcomputer New-Brain is revealed for the first time to the general public. This British-designed product is the first of a new generation of hand-held microcomputers, featuring the following: full QWERTY keyboard, advanced Basic compiler, full set of interfaces including analogue and addressing up to 4MB of store. This fully-expandable device incorporates features found previously only on mainframe computers.

Newbear, a sister company of Newbury Laboratories, is also showing various micro-related products and books.

Online Conferences Ltd

Argyle House, Joel Street,
Northwood Hills, HA6 1TS.
Tel: 09274 28211

Stand 1b

ONLINE is a organisation specialising in the co-ordination of significant high-level conferences and exhibitions in the fields of information processing and communications technology.

The 1980 Microcomputer Show is the

SUPERBRAIN™

FROM **SUN** THE GROUP WITH MORE THAN 100 YEARS' CUMULATIVE HARDWARE EXPERIENCE IN THE COMPUTER INDUSTRY.



NOW WITH

- TWO QUAD-DENSITY FLOPPIES (788K) OR TWO DOUBLE-DENSITY (320K)
 - TWIN Z-80A MICROPROCESSORS
 - 64K RAM
 - CP/M OPERATING SYSTEM
- RECOMMENDED PRICES

£1,950 (320K)
£2,550 (788K)

TELEPHONE OR WRITE FOR NAME AND ADDRESS OF YOUR NEAREST DEALER
DEALER ENQUIRIES WELCOME

SUN COMPUTING SERVICES LTD

138 CHALMERS WAY, NORTH FELTHAM TRADING ESTATE,
FELTHAM MIDDX. TEL: 01-751 6695

REMEMBER AS MAJOR DISTRIBUTORS OF INTERTEC PRODUCTS, WE PROVIDE OUR DEALERS WITH

- EXTENDED "NO QUIBBLE" WARRANTY
 - FULL SUPPORT SERVICE
- COMPETITIVE MAINTENANCE AGREEMENTS; REPAIR SERVICE; IN-HOUSE SOFTWARE DIVISION; BUSINESS PACKAGES

SUPERBRAIN™ is the registered trademark of Intertec Data Systems.

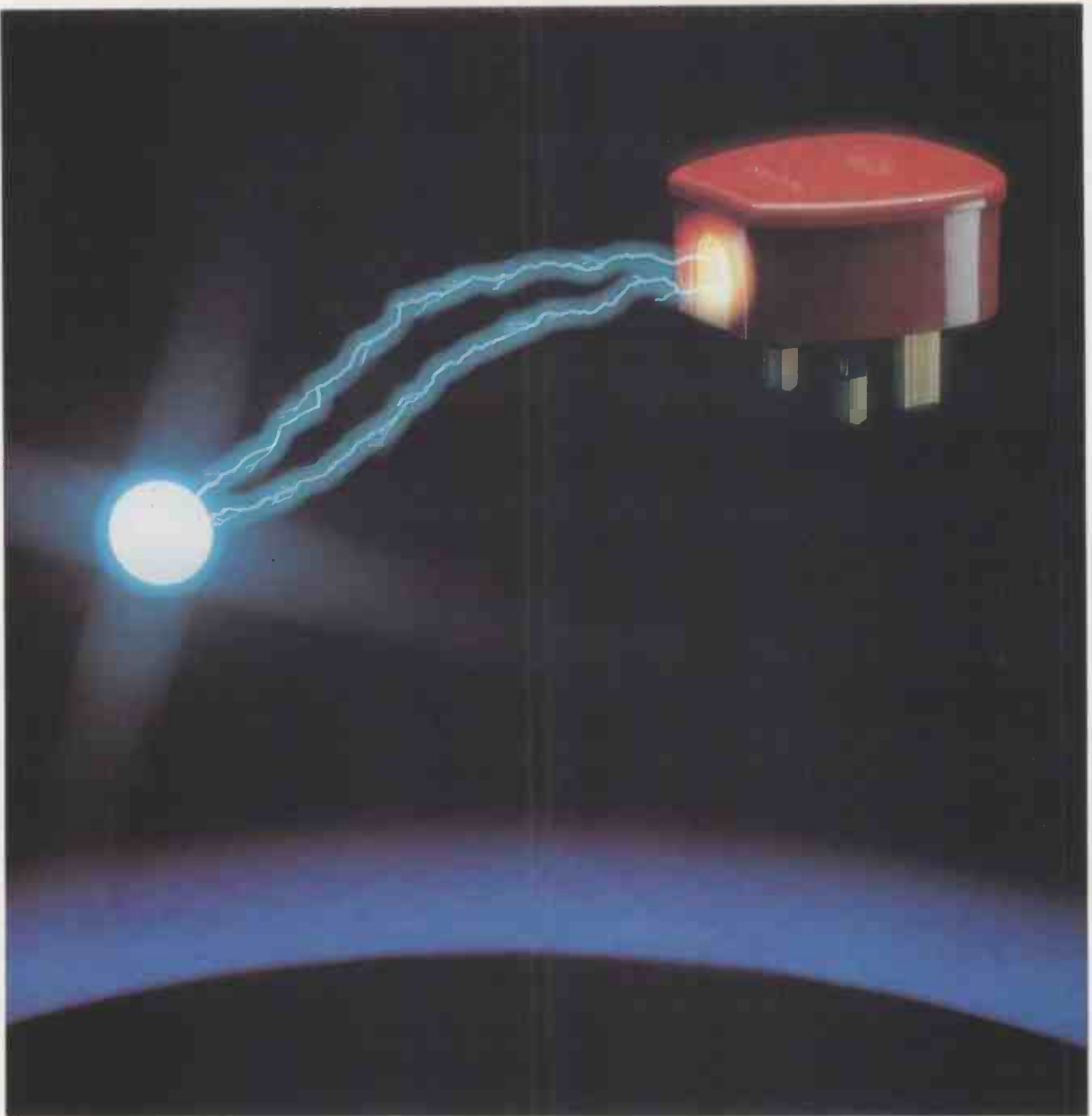

PLUG INTO THE FUTURE WITH US

TDS Circuits (Blackburn) Ltd
High quality PCBs on a guaranteed rapid delivery

Pelikan (Vario-printer)
Software controlled high speed variable font printer

ICS Integrated Computer Systems
Complete range of courses on the application of microtechnology with hands-on workshops

Dunford & Hepburn Ltd (Newcastle-upon-Tyne)
Applied microprocessor technology and tutorial development systems

AT THE NATIONAL MICROPROCESSOR AND ELECTRONICS CENTRE



London World Trade Centre,
Europe House, East Smithfield, London E1 9AA.
Tel: 01-488 2400. Extn: 250/1/2.
Cables: Worltrade Ldn. Telex: 884671. Prestel: 350 33399

Teknis Ltd
DIP Test Handlers, anti static aids fibroptics & electronics

Sumlock Bondain Ltd
Advise, supply and install all leading makes of minis/micro computers

British Central Electrical Company Ltd
Direct connection to delicate components — EZ testhooks protect PCBs against overloads and short circuiting with the PROB MCB

Research Machines Ltd
Microcomputers for the engineer

INCORPORATING A YEAR ROUND DISPLAY OF MICROCOMPUTERS IN ACTION

fifth micro show that Online have organised. Last year thousands of visitors packed the Bloomsbury Centre Hotel — hence the decision to change this year's venue to Wembley Conference Centre. Earlier this year, Online also ran its first ever micro show in the North West — the successful Mersey Micro Show and it is now certain that this event will be repeated next year.

Padmede Computer Services Ltd

The Tuns, 112-116 High Street,
Odiham, Hants RG25 1LS.
Tel: 025 671 2434 Telex: 585575
Sales contact: John Packwood

Stand 46a

DISPLAY and demonstrations will be given of the Padmede-developed and written Apple/ITT 2020 business software. Applications include incomplete records accounting, nominal ledger, sales ledger, purchase ledger, invoicing, stock control, time and cost recording, insurance broker system, job costing. Also on display is VisiCalc, Desktop Plan and Apple writer.

Padmede's successful incomplete record accounting system with considerably more than 100 users has formed the basis for standard, reliable, software modules, used in its other systems. Operating techniques are the same throughout, so operation is easy and all systems are superbly documented.

Personal Computers Ltd

194/200 Bishopsgate,
London, EC2M 4NR.
Tel: 01-626 8121 Telex: 888264
Sales contact: Mike Sterland

Stand 33

PERSONAL Computers is showing Apple III for the first time. It is also exhibiting financial planning and word processing software for Apple II, together with a new 80-character card and alpha-numeric keypad. In addition, a powerful range of printers are on display. These include Qume 5/45 RO, Paper Tiger, TCM 100/200, as well as new Centronics 730. Each printer has certain characteristics for particular applications.

A number of new interfaces are on show, including parallel/serial card and a specialised music synthesizer interface, the Super Sound Generator. A specialist is also on hand to demonstrate the very latest, low-cost computer graphics with Apple graphics table.

Personal Computer World

14 Rathbone Place, London, W1.
Tel: 01-637 7991 Telex: 8954139
Sales contact: Stephen England

Stand 34

Personal Computer World is Europe's biggest-selling microcomputer magazine. Every issue carries more news than any

other monthly, benchmarks on latest equipment and a complete buyers' guide to microcomputers. Readers in the business, hobby and education sectors find articles on software, hardware, books, games and languages. On sale is the current issue of *Personal Computer World*, back issues and binders. Editorial and advertising staff are on hand to discuss any problems in detail.

Practical Computing

Dorset House,
Stamford Street, London SE1 9LU.
Tel: 01-261 8000 Telex: 25137
Sales contact: Tom Moloney

Stand 25

THE U.K.'s leading microcomputer journal, *Practical Computing*, is for those who are interested in putting low-cost computers to work in small businesses, schools and colleges and the home.

Each month, *Practical Computing* carries at least one hands-on test of a popular microcomputer, providing just the information you need — technical data and unbiased critical comment on the strengths and weaknesses of each system. Each issue is packed with essential reading on microcomputers and back issues are a valuable source of reference for those who are considering the purchase of microcomputers, peripherals. Visit us on Stand 25 to check whether we have reviewed the equipment you are interested in.

Product Launch Ltd

West End House, Hills Place,
London W1.
Tel: 01-445 8452

Stand 30

PRODUCT Launch and associates will be exhibiting examples of the various services it has to offer. Product Launch is actively promoting a number of new products that are being created in the U.K. This company takes on the initial promotion and co-ordinates the marketing, advertising, PR, sales training, sales promotion, exhibitions, seminars, etc., which may be necessary to launch the product.

Specialist Micro Design is another part of the group. This company consists of the entire team that created Nascom Microcomputers and has extensive experience of microcomputer design. The team works for some of the largest companies in the country and is at the exhibition to discuss future projects with people who may well have an interest in designing a new product or in enhancing existing products.

Quality Systems International Ltd

Imperial House, 108-110 New Walk,
Leicester LE1 7EA.
Tel: 0533 543553

Stand 60

QUALITY Systems International will exhibit a new intelligent point-of-sale terminal designed in Britain. The use of microprocessors and low-cost peripheral hardware enables QSI to offer a complete system which includes an alpha-numeric single-line display, two hard copy alpha-numeric printers for customer receipts and audit trails etc., and a data cartridge for the logging of daily or weekly transactions for subsequent processing. A fully-equipped alpha-numeric keyboard which may be customised specially is also supplied as standard.

Various options are available including bar coding, bubble memory for priced look-up tables, magnetic card readers and communications. The QS5000, the first point-of-service system to be released by QSI and all its other models are capable of supporting applications which may be designed to meet customers specific requirements.

Research Machines Ltd

P.O. Box 75, Oxford, OX2 0BW.
Tel: 0865 49792

Stand 17

RESEARCH Machines is showing its Z-80A-based microcomputer in various configurations. 380-Z is available as a floppy-disc or cassette-based system. Disc-based systems include the industry standard CP/M operating system and use either mini-floppy discs or double-sided standard eight in. discs, which provide one megabyte on-line storage.

One system on show demonstrates the RML high-resolution colour graphics option. Resolution of graphics is 319 × 191. Alpha-numeric can be mixed with graphics and graphics picture can either be combined with normal VDU display or displayed on a separate screen. Board incorporates its own 16Kbytes of RAM.

Sigma U.K.

6 The Jays, Burgess Hill, Sussex.
Tel: 04446 44159

Sales contact: John Dobson

Stand 15

SIGMA U.K., an associated company of Sigma International, Scotsdale, Arizona, shows products from its comprehensive wholesale range. Included in a number of products new to the U.K., is the Sintelwriter, a letter quality printer based on the NEC Spinwriter mechanism and the Datasouth 180, a 180 cps matrix printer.

VDUs are represented by the Visual Technology 100 and 200, the former a DEC VT-100 plug-compatible unit, and the latter an intelligent terminal which is switch-selectable to emulate several popular terminals. The Z-800A-based ONYX 8001 system will be featured for the first time in the U.K. This has a built-in eight in. Winchester disc, 10MB 3M

tape drive, plus upgrade capability to the Z-800-based 8002 system.

Sirton Computers

76 Godstone Road,
Kenley, Surrey CR2 5AA.
Tel: 01-688 0761
Sales contact: Mrs M E Alan

Stand 11

SIRTON Computers is displaying its Midas range of microcomputers which cover the spectrum from non-disc-based units with single-board computers through to units with eight in. double-sided disc drives giving 2Mbytes of on-line data storage. A Winchester hard disc unit is now available providing additional storage capacity between 10 and 20Mbytes.

A large range of S-100 boards, including real-time clocks, high-density graphics, colour graphics, A/D/D/A, Serial/Parallel I/O boards etc., are kept in stock and can be used to configure special customised systems. Dealer and OEM enquiries are welcome for our Midas systems. DPS-1 computer with the MPU-80 from Ithaca Intersystems is also featured on the stand together with a disc enclosure for dual eight in. drives.

The Software House

146 Oxford Street, London W1.
Tel: 01-637 2108
Sales contact: Ann Jones

Stand 49

THE Software House sells one of the largest ranges of software in Europe for most popular makes of micro, the Apple II microcomputers and all associated products. It imports manufactures, writes and distributes software both wholesale and retail, and is the sole distributors of the 80 U.S. Magazine. Mad Hatter Software is an associated company, wholesaling American software.

The Software House full range of software programs is available, with sample programs on display and for purchase.

Systematics International

Essex House, Cherrydown,
Basildon, Essex.
Tel: 0268 284601
Sales contact: Ron Young

Stand 40

SYSTEMATICS International is a software developer and distributor for the Apple II and ITT 2020 microcomputer systems. At the show, it is launching several new software products which include an accounting system written in Pascal, The Easy Writer family of products consisting of a word-processor system containing 80 column upper- and lower-case display, The Easy Mover, a program which can transfer files from one Apple to another by telephone.

Other new products to be exhibited for

the first time include the text file library, home finder and typing tutor. Our new software catalogue, Edition II, which has a wider range of programs for businesses will be available on the stand along with staff who will be available to answer any questions.

Tandy Corporation

Bilston Road, Wednesbury,
Staffordshire WS10 7JN.
Tel: 021 556 6101 Telex: 339423
Sales contact: J D Hardman

Stand 47

THE TRS-80 has taken 10 percent of the non-mainframe U.K. market in just 10 months and it is not hard to see why. TRS-80 is an attractively-packaged, user-orientated unit with detachable keyboard and the kind of features you would expect with a £2,000 plus price tag. The TRS-80 range has found users in a wide range of settings, including homes, small businesses, schools and colleges.

The system, being modular, can be expanded to deal with changing or developing user needs. Examples of the accessories available comprise printers, computer games, voice input and synthesiser and additional disc drives, upgrading the TRS-80 to a full 64K memory.

Tangerine Computer Systems Ltd

Forehill Works, Forehill, Cambs.
Tel: 0353 3633
Sales contact: B Muncaster

Stand 27

EXHIBITED is Microtan 65 System, based on the 6502 microprocessor, a fully-expandable and powerful microcomputer which uses 8K extended Microsoft Basic. Peripheral modules include Bulk I/O, Ceefax-compatible, high-definition colour graphics, 40K RAM on a single-board Tanex Expansion Module, IEEE Bus Interface, Tandos controller and drives, mini-racks and system racks, full ASC11 keyboards, Rockwell Aim-65 expansion modules, TV interface, interface module allows expansion via Microtan System rack and Microtan standard modules. The Microtan System is an ideal educational and personal microcomputer, British-designed and manufactured.

Telefusion Ltd

Telefusion House,
Preston New Road, Blackpool.
Tel: 0253 661111 Telex 67446
Sales contact: A Webb

Stand 37

TELEFUSION offers a comprehensive service for supply and maintenance of microcomputers to all relevant applications. Particularly featured is the latest ITT 2020 computer with a full range of supporting hardware and a comprehen-

sive selection of software. Also on display is a microcomputer with full Prestel facilities.

Total Concept Systems Ltd

379/381 High Road, Leyton,
London, E10.
Tel: 01-539 7194
Sales contact: SJ Whine

Stand 9

ON DISPLAY is Apple II with electronic cash register and bar code reader demonstrating use of equipment in retail environment. Also various Apple II peripherals such as Graphics Tablet and Apple II application packages. Also Cromemco microcomputer with peripherals demonstrating solicitors', estate agents' and wholesalers' packages.

Transam Computers

12 Chapel Street, London NW1 5DH.
Tel: 01-262 0814
Sales contact: Mr Stride

Stand 31

TRANSAM a manufacturer of computer systems is showing for the first time, the Tuscan S-100 microcomputer, the cheapest S-100 system available. Transam is an exclusive European distributor of the Constructor Floppy Disc Controller from the U.S. manufacturer Dataspeed. Microcomputer products including interfacing, media, disc systems, terminals and memory components.

Premiere at the show are TCL Pascal for Pet, written and developed by operating systems — Research Machines 380Z, TRS-80. With a showroom in West End of London, Transam is the manufacturer of the highly-successful Triton range of computers, a computer kit system sold internationally.

Walters Microsystems Ltd

1 Blenheim Road, Cressex Industrial Estate, High Wycombe, Bucks.
Tel: 0494 445172 Telex: 837600
Sales contact: S Walker

Stand 35

ON DISPLAY the Dolphin BD80P, marketed in U.K., Europe, Africa and Australasia with new markets opening daily. British-made, 80- (132 optional) column line printer, it combines simple mechanical design with sophisticated microprocessor control providing a unit with excellent reliability and performance. Its versatility, utilising any one of three interface boards, makes it suited ideally to many systems, computer terminals or data acquisition equipment.

Also exhibited is Cobra BD136, latest in a line of low-cost, high-performance computer output terminals. It uses microprocessor control to maximise overall printing rate by removing print head the shortest possible distance to start or end of next line.

ACORN ATOM



The elegant injection moulded plastic case houses a full size professional keyboard and a hardware/software combination of extraordinary power and versatility; in the minimum price configuration the kit of parts provided allows BASIC and ASSEMBLER, graphics and sound output, direct cassette and T.V. interface and much more. Sockets and connectors allow for expansion *within* the case to allow features normally associated with computers costing ten times as much.

Every kit is sent with assembly instructions and a beginners guide to Atom BASIC, ASSEMBLER and operating system.

The basic unit in kit form costs £120 plus VAT and postage, total £143.00. Prices and details of ready built units and accessories on request. Delivery in beginning of May.



Acorn Computer Ltd.,
4a Market Hill,
Cambridge, CB2 3NJ
Tel. (0223) 312772

- Fast 32-bit Integer BASIC
- Floating point math routines (10 digit)
- Mnemonic Assembler
- Cassette load and save
- 16 letter file names
- Graphics Plot, Draw and Move
- Screen editor
- Timer function
- Many extended BASIC features
- 192 Graphics characters
- 5 Graphics modes
- High resolution (256 x 192)
- Internal speaker
- Printer output
- UHF output
- Monitor output
- Colour output
- Communication loop
- Cassette I/O
- 24 User I/O lines
- Internal socket for any Acorn card
- Acorn bus output

HARD. AND FAST.



Corvus/Constellation. A new concept in mass storage and shared data multiplexing for Apple, TRS-80, Pet, S100 and LSI-11.

Hard and fast. Corvus and Constellation. Together they offer a tremendously powerful mass storage solution to the problems of micro-computers.

The Corvus hard disc drive is far superior to floppies - your disc accessing speed will normally be about twenty times faster. And any problems of back-up transfer are eliminated by the unique Corvus Mirror system which allows you to dump onto a video tape recorder at 1Mb per minute.

If you have a microcomputer system you just plug in and go, like any of your other peripherals. All the interfaces have been designed and

tested to work with your existing software, so there is no new disc operating system to learn.

And Constellation is the way to turn your computer into a multi-user system. Ideal applications are word processing, stock control and education. Link together two to sixty four computers sharing up to 40Mb of Corvus capacity (four eight-inch Winchester disc drives), share the peripherals and communicate with other computers in the network.

You can implement a Corvus disc system as a simple single-user computer system and upgrade later to a multi-user network with no penalty in

cost or software effort. The computer interface hardware is the same as for the single-user disc system, while the operating system software is that provided with the host computer.

It's a powerful argument. Ask Keen to tell you more about it.

Keen Computers

5b the Poultry, Nottingham NG1 2HW.
tel: 0602 583254.
telex: 37297 (keenco)

28 Lower Addiscombe Road,
Croydon CR0 6AA. tel: 01-680 4646



RAIR BLACK BOX
MICROCOMPUTER

POWER
LOAD
RESET

RAIR MICROCOMPUTER
BLACK BOX

*Discover the secrets of
the RAIR Black Box*

The small business system that won't let you down

VECTOR MZ FROM COMPUTASTORE

Computastore has combined the powerful Vector MZ microcomputer with the reliability of proven accounts packages to bring you the benefits of a Small Business Computer at a price you can afford. With a high speed printer, the total system costs £5500, including installation and training – no extras to pay.

The integrated accounts packages provide the flexibility and ease of operation that first time users demand. Operator training is provided at YOUR premises, using YOUR data to get your system working within days. And because our accounts software has been developed in-house, the standard packages can easily be tailored to meet your needs exactly.



■ **SALES LEDGER:** Open item system, produces statements and current aged debtors balance at any time – not just at month end.

■ **PURCHASE LEDGER:** Open item system, produces aged creditors balance and remittance advices at any time – you choose the items you want to pay.

■ **NOMINAL LEDGER:** Links with both sales and purchase ledgers. Compares actual with budget, and with same period previous year.

■ **ONE OFF SOFTWARE:** We will be pleased to quote for any other commercial application.

■ **WORD PROCESSING OPTION:** Combine your word and data processing on the same system.

TECHNICAL OVERVIEW:

Vector MZ: Industry standard CP/M operating system, 48K RAM, 630K Disk Drives, Fast Z80 microprocessor, S100 bus.

Mindless Terminal:

High quality 80 x 24 upper and lower case display, Typewriter style keyboard, with numeric keypad.

Texas Instruments 810:

150 c.p.s. high quality dot matrix printer.

ONLY £1,700 32K Vector MZ complete with 630K disk drives, CP/M, C/BASIC and NAD.

Full Range of Low Cost Accessories by Mail Order.

* Barclaycard and Access welcome.

HARDWARE, SOFTWARE and ACCESSORIES sold either as complete systems or separately.



All goods in stock NOW, so why not call in for a demonstration, or ring or write for further details.



Computastore

Software That Means Business

16 John Dalton Street
Manchester M2 6HG
Tel: 061-832 4761

• Circle No. 177

Back-room micro brings latest techniques for service agent

IT CAME as a surprise to me to see the familiar flicker of a VDU in the back room of the Kevlin Service Company. My mind was on cleaners not computers at the time and somehow the little vacuum cleaner shop tucked in a back street of Hammersmith in London hardly seemed as though it would be in the forefront of modern service techniques.

Yet there it was, occupying pride of place in the cramped office; a Bytronix Lyte keyboard and VDU with a purposeful-looking processor and twin drives racked underneath the desk and printer.

Several scares

On the other side of the room, the fizz of white noise was shot through with the squawky voices of the road service engineers out in their vans, reporting to base on a two-way link. Clearly this was no ordinary repair shop.

Tom Kevlin, the proprietor of the company, told me he had been interested in the idea of using a computer to improve the efficiency of his operation for several

The Bytronix Lyte keyboard and VDU operated by Christine Edgington.

years and had had several scares which indeed made him wonder whether it was all worth it.

Essentially his operation is midway between retailing and wholesaling. As a main Hoover supply and service agent, he sells and services domestic appliances, both new and second-hand. He has six service vans on the road which call on customers; repairs may need any of the 14,000 Hoover listed parts.

Since the main Hoover parts depot is in Bolton, Lancashire, Kevlin also acts as a

by Martin Hayman

local "buffer" parts depot, selling direct to the trade, and retains a full-time representative to sell these parts. Since the delay between the time of ordering and the time of receipt is from three to five weeks, it is crucial for the smooth running of the operation that stock be rigorously controlled and orders despatched promptly as soon as stocks of any particular item in Kevlin's warehouse start to fall low.

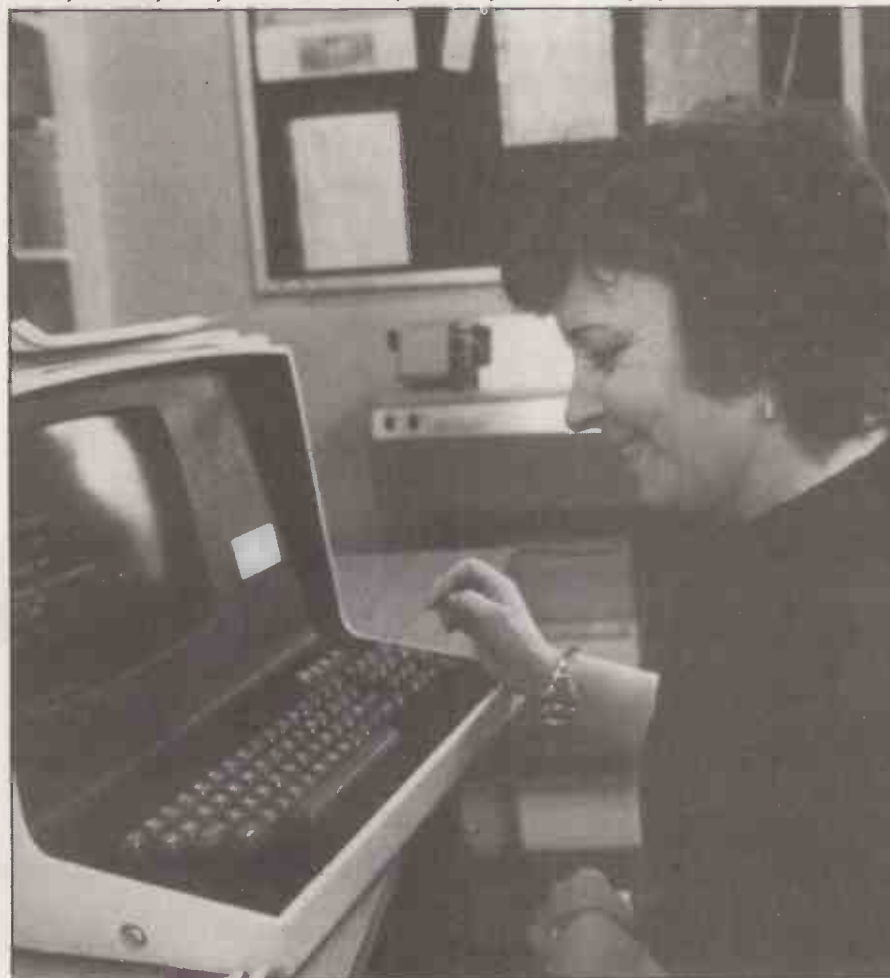

That means that inputs from the van engineers, the on-the-road sales representative, in-house and guarantee work on new appliances all have to be collated against the running total of spares in hand.

That had been handled previously by a Kalamazoo card-system. It required constant concentration to ensure that it did not fall behind and made the card-handling clerk indispensable. What happened, for instance, if he went away on holiday — even for a week? "Absolute chaos", answers Kevlin.

Theory and practice

The theory ran that a computer would be able to tie all the stock accounting and invoicing together, along with payroll — the service engineers' bonus is calculated according to the number of jobs above a certain minimum per week — and certain specialised items like guaranteed-work credits. In practice, finding a machine for such an application was more difficult and more fraught with perils than Kevlin had imagined.

He took his staff to the National Exhibition Centre at Birmingham for the International Business Show in 1977 and was rather taken aback by the pushiness of the mainframe manufacturers' salesmen, and doubtful about the kind of prices quoted — £16,000 and upwards for the hardware alone.

Rejected proposal

Later he signed for an initial £8,000s' worth — only to find that to have the system running the way he wanted, he would have been committed to another £24,000 over the following three years, along with the supposed big-company benefits. The proposal was rejected and he set to work to study the micro market with the help of *Practical Computing*.

By this time he had learned that hardware was by no means the whole story. He discovered that one of his business acquaintances in the same kind of operation, a washing machine service company called Washvac, was using a micro supplied by a new local firm called Bytronix, and that its system was working well for a total outlay of a quarter the large firm's final quote. Robin Wood of Bytronix arranged for a demonstration: "What impressed me most about Bytronix was that they quoted us a package price, with software", says Kevlin.

Although the big companies had warned Kevlin of the small manufacturers — "Why bother with these unknowns when they may not even be in business this time next year"? was the

usual line — he liked the look of what was on offer and decided that the small company offered not only the better deal on price but also seemed flexible enough to cope with any breakdown.

The owner of Bytronix, Tim Avens, is a master mariner and on retirement from the Merchant Navy, formed a central-heating business in Farnham, Surrey. He encountered very similar problems to those of the Kevlin Service Company and indeed of many businesses — too much paperwork taking too much time and for too few results.

Problem solving

So he bought an Altair kit, soldered it and found that it did not do what he wanted it to do. So he set-up Bytronix which Robin Wood joined after a career in and around business machines and mainframe computers. Their approach is essentially one of problem solving — ideally they would require a client to know nothing of computers, but to analyse carefully his own business requirements. They can then supply a system to fulfil those needs. Obvious? Not always in practice.

So the Bytronix system was installed in Kevlin's back room, occupying the remaining space left vacant by the two-way radio control which had been fitted less than two years previously. Wood was on hand to oversee and to allay the co-opted operator's fears at handling a

computer. "You have to instil confidence in the system", says Wood. "I arrived at about 2.30 pm and didn't leave until about 7 pm. I told Chris to go ahead and run the payroll the next morning and to telephone immediately if she had any problems. There weren't any".

Disc removal

"Yes there were —", interrupts the personable Christine "when I arrived at the end, I didn't know how to take out the discs". Yet before the event, she had admitted to being terrified of tackling the system. The 13-man payroll now runs in five minutes, where before there was a three-hour panic on Friday afternoon between banking the week's takings and assessing the week's stock depletion for forward orders.

As it stands, the system consists of a Z8080-based 32K Megamicro processor with two serial and two parallel ports, twin DRI 7200 drives, single-density, double-sided floppy discs, a Lyme 4002 display with upper- and lower-case, and a DRI 6320 printer. With the modified sales-ledger and stock-control package — which features four kinds of invoice, a parts description directory and a special routine to convert Hoover part numbers to a form handled more easily by the machine — total cost worked out at slightly more than £8,000 and prompt service if the machine ever breaks down. There have been two minor hitches since

last August when the machine was installed.

As for the visible benefits so far, Kevlin says: "Our stock control is much more efficient now. Before it was installed we were in chaos. There used to be a panic hour every Friday afternoon. Like most small businesses, we all do two or three jobs here. We would be doing the payroll, worrying about arriving at the bank on time, trying to talk to the engineers or customers on the telephone and someone has to serve in the shop, but it has done away with all that panic and a good deal of paperwork too".

Further benefits

There are further benefits for operations such as updating prices — a bulk update takes the machine 20 minutes, where before it meant rifling through the catalogues with a ready reckoner and a pen in hand. The monthly stock-taking is now simplicity itself — another three working evenings saved for all staff. With insurers now looking to know exactly what and how much goods they are insuring, that is another indispensable chore which the micro has removed.

Finally, of course, it is the bottom line that every business is looking at. Tom Kevlin illustrates: in the first quarter of 1979, before the micro was installed, turnover was £30,000. The return for the first quarter of this year is £42,000. □

POWERFUL MICROS AT THE RIGHT PRICE

- Multi-User ● Multi-Tasking
- Multi-Language ● Hard Disc Storage ● Word Processing
- Priced from under £5000

Languages supported include — Basic, Cobol, Fortran.
OEM, Educational and Dealer enquiries invited

EQUINOX

COMPUTER SYSTEMS LIMITED
Kleeman House, 16 Anning Street
New Inn Yard, London EC2A 3HB
Tel: 01-739 2387 & 01-729 4460

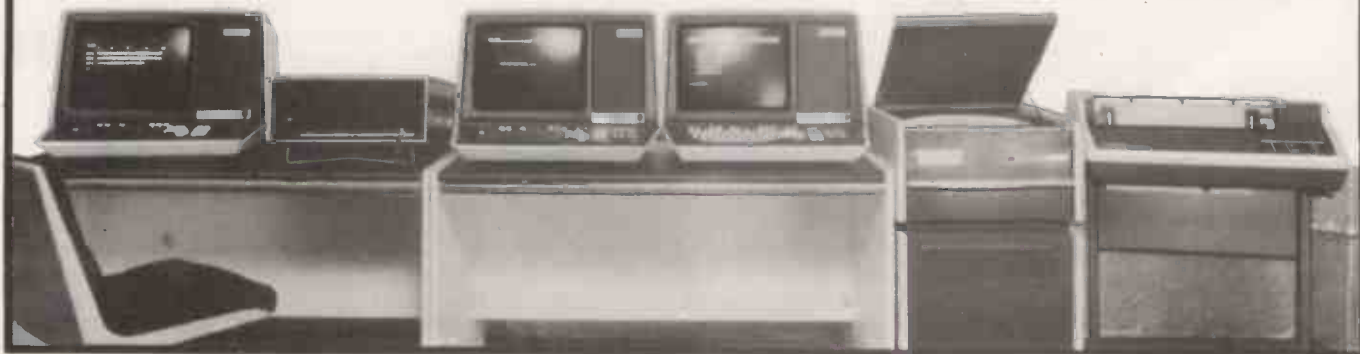

Hard-copy capability which is soft on the pocket

John Dawson describes how to obtain hard copy from the Nascom 1, said to be the most popular U.K. single-board computer, using the inexpensive Creed teleprinter.

IN ITS standard form, the Nascom 1 displays information in transient soft form on a TV screen. The program described is designed to print the contents of the TV screen, the VDU RAM, in the format in which it is presented on the TV. Subroutines in the program can be called, however, to print a character or a line in whatever format the programmer chooses.

The printer interface enhances the capability of the Nascom out of all proportion to the cost and effort involved in making the hardware and writing the program. Creed teleprinters are available on the surplus and amateur markets for between £5-£25.

Interface components

Components for the interface should cost less than £15 and the software is designed to output serial CCITT 5 unit code, suitable for standard Creed 75 and 7 series machines. Some Creed teleprinters were modified for use as computer output

Figure 2.

CREED MODEL 7		PERFORATED TAPE					INTERFACE CODE	
Lower case	Upper case	Code		Elements				
		1	2	3	4	5		
A	-	03	83
B	?	19	99
C	:	0E	8E
D	Who are you	0B	8B
E	3	01	81
F	2	0D	8D
G	2	1A	9A
H	2	14	94
I	8	06	86
J	Bell	0B	8B
K	(.	0F	8F
L)	12	92
M	1C	9C
N	0C	8C
O	9	1B	9B
P	8	16	96
Q	1	17	97
R	4	0A	8A
S	06	86
T	5	10	90
U	7	07	87
V	=	1E	9E
W	2	13	93
X	/	1D	9D
Y	6	15	95
Z	4	11	91
Carriage return		48	48
Line feed		42	42
Letters		1F	1F
Figures		1B	1B
Space		44	44

● = Mark

Look-up table byte format

7	6	5	4	3	2	1	0
---	---	---	---	---	---	---	---

↑ CCITT code 1

↑ Special character

↑ Figure/letters

devices and these printers may have unusual type fonts and coding. The output from the interface, however, is controlled entirely by software and can be adapted easily.

The CCITT code comprises seven elements in all. The first element starts the

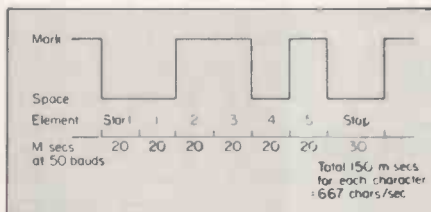

Figure 1.

machine cycle, five elements make-up the character code and a half times the length of the others, completes the cycle. There are 32 combinations possible from five elements and a mechanical register in the teleprinter is used to allow a second set of 32 characters to be printed.

One code sequence in each set, figures/letters shift, is interpreted by the printer as a command to shift the register before characters in the alternate set are printed. For example, this character sequence requires the appropriate shift character to be inserted in the places marked *.

1 2 3 * THE QUICK * 4 5 * B * 9 * A * 6 7 * BROWN FOX * 0 8 9

A character construction for the letter P and figure 0 is shown in figure 1 and the whole CCITT code is displayed in figure 2.

Varying speeds

Teleprinters run at various speeds — 45.5, 50 and 75 bauds. A baud is the reciprocal of the time of one signal element. A teleprinter running at 50 bauds has a signal element length of 20 mSecs — 1 second/50 bauds. The program was written for a 50-baud machine but other speeds can be achieved by changing the timing-loop variables in proportion.

Teleprinters are reliable and well-built pieces of light machinery capable of operating continuously or intermittently for long periods before servicing is required. Nevertheless, maintenance is necessary and, particularly in the case of older machines, adjustment to the manufacturer's specification may not be sufficient.

A form of tuning may be required in which one out-of-tolerance adjustment is

offset or balanced by another. The Radio Society of Great Britain (RSGB) publishes *Teleprinter Handbook* which contains a wealth of practical detail and is essential reading for anyone acquiring a Creed or other teleprinter for the first time. The British Amateur Radio Teleprinter Group (BARTG) is also a valuable source of information and sometimes, spare parts.

Interference and voltage surges produced by the teleprinter motor may cause erratic operation of the Nascom. There are three types of motor found in teleprinters; two, 230V and 24V AC/DC-governed motors, will produce interference while running and may require suppression additional to that fitted already inside the printer.

The third type, synchronous motors, produces no interference while running but

0C50	01	30	00	21	5D	0C	11	0D
0C58	08	ED	B0	18	2E	6F	75	74
0C60	70	75	74	20	73	71	75	61
0C68	72	65	77	61	76	65	20	70
0C70	6F	72	74	20	30	20	62	69
0C78	74	73	20	32	2F	35	20	20
0C80	20	20	20	20	20	20	20	20
0C88	20	20	20	3E	00	D3	00	F5
0C90	06	80	CD	35	00	10	FB	F1
0C98	CB	D7	CB	EF	D3	00	F5	06
0CA0	80	CD	35	00	10	FB	F1	18
0CA8	E2							

Figure 4. Program to output a squarewave to port 0, bit 2 and bit 5.

may cause a surge or disturbance in the AC mains when starting or stopping. It may be worthwhile replacing a governed motor with a synchronous alternative, at the same time disabling the cut-out that stops the printer sometime after the end of a message.

Figure 3 is the circuit diagram of the interface which is adapted from the double current magnet driver circuit described in chapter 6 of the RSGB handbook. Port 0 of the Nascom is used predominantly by the keyboard but has two spare bits available to the user.

A signal is taken from bit 2 of port 0 at TTL levels and drives the two Darlington power transistors alternately. A constant current of about 25mA is switched one way through the teleprinter magnet for a mark condition, and in the opposite direction for a space.

The components of the interface can be mounted directly on to Veroboard and neither the lay-out, nor the component values appear to be critical. The three 1.2K resistors in series with the teleprinter

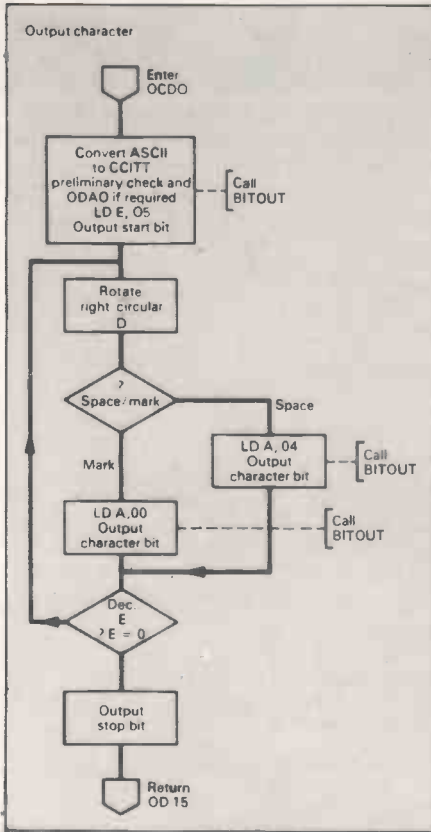

Figure 5.

magnet each dissipate approximately two Watts. The resistors should be wire-wound, rated at five Watts or more and mounted at least 1cm. clear of the Veroboard. Ventilation of the board and resistors is desirable.

No protection against back EMF from the teleprinter magnet is required as the Darlington power transistors are allowed to reversibly break down, within the manufacturer's specification. The transistors are rated to absorb up to

25mJoules of unclamped inductive load energy; well in excess of that produced by this circuit.

The 72-V supply is somewhat lower than the 80V recommended for driving a double-current circuit. If higher voltages are used, it would be sensible to replace the TP110 transistors with others in the same series — TIP111 to TIP112. In practice, the distortion introduced by the lower voltage is insignificant and has caused no trouble in several months' use with a surplus Creed 75 printer.

Software design

The software was designed from the bottom up and was developed using the Nasbug T4 monitor. It should run without alteration on machines equipped with the T2 monitor. The flowcharts followed when it was all working. A test program was written to switch port 0, bit 2 continually on and off.

At slow speeds, the program was useful in tracking bit 2 at the far end of a re-wired and extended keyboard cable using a voltmeter. Figure 4 is a printout of this routine. Shortening the delay loops produces an audio frequency which can be taken easily to an audio amplifier.

The program is based on the subroutine at 0D16 (BITOUT) which sets or re-sets bit 2 port 0 depending on the value in the accumulator when the subroutine is entered. The subroutine waits 20 mSecs after the output instruction, set by variables at 0D1B and 0D1D, and then returns to the calling program.

Figure 5 is a flowchart for the character output routine. The routine is entered with the ASCII value in register C. The registers are saved and a reference value (0D10) is loaded into HL. Register B is set

(continued on page 107)

0C50	CA 07	0A 08	39 08	00 08
0C58	0D 00	F1 E8	0B 50	0C 00
0C60	00 00	00 00	00 00	00 00
0C68	00 00	CD 6E	0C CF	00 AF
0C70	32 56	0C 06	02 0E	7F CD
0C78	D0 0C	10 F9	CD 90	0D 21
0C80	58 0C	36 0E	2A 50	0C 22
0C88	52 0C	01 40	00 2A	52 0C
0C90	09 22	52 0C	01 2F	00 09
0C98	22 54	0C 21	58 0C	46 05
0CA0	70 20	01 C9	C5 D5	E5 F5
0CA8	06 30	2A 54	0C 3E	20 56
0CB0	BA 20	05 2B	10 F9	18 0A
0CB8	2A 52	0C 4E	CD D0	0C 23
0CC0	10 F9	F1 E1	D1 C1	0E 5E
0CC8	CD D0	0C CD	90 0D	18 BA
0CD0	C5 D5	E5 F5	06 00	21 10
0CD8	0D 09	7E 32	57 0C	CB 77
0CE0	CC A0	0D 3A	57 0C	57 1E
0CE8	05 3E	04 CD	16 0D	CB 0A
0CF0	38 07	3E 04	CD 16	0D 18
0CF8	05 3E	00 CD	16 0D	1D 7B
0D00	20 EC	3E 00	D3 00	08 D9
0D08	06 04	3E F0	FF 10	FB D9
0D10	08 F1	E1 D1	C1 C9	D3 00
0D18	08 D9	06 03	3E E0	FF 10
0D20	FB D9	08 C9	00 00	00 00
0D28	00 00	00 00	00 48	42 42
0D30	44 84	85 94	94 8D	9A 85
0D38	8F 92	91 91	8C 83	9C 9D
0D40	96 97	93 81	8A 90	95 87
0D48	86 98	8E 8E	48 9E	44 99
0D50	9A 03	19 0E	09 01	0D 1A
0D58	14 06	0B 0F	12 1C	0C 18
0D60	16 17	0A 05	10 07	1E 13
0D68	1D 15	11 8F	9D 92	42 44
0D70	85 03	19 0E	09 01	0D 1A
0D78	14 06	0B 0F	12 1C	0C 18
0D80	16 17	0A 05	10 07	1E 13
0D88	1D 15	11 8F	9D 92	9B 1F
0D90	0E 3C	CD D0	0C 06	12 CD
0D98	35 00	10 FB	C9 00	00 00
0DA0	C5 D5	E5 F5	21 57	0C 3E
0DA8	80 A6	2B BE	28 14	CB 7E
0DB0	28 09	CB BE	16 1F	C3 E7
0DB8	0C 18	07 CB	FE 16	1B C3
0DC0	E7 0C	F1 E1	D1 C1	C9 00
0DC8	00 00	00 00	00 00	00 00
0DD0	2A 5B	0C 22	5D 0C	06 06
0DD8	2A 5D	0C 11	68 00	19 22
0DE0	5D 0C	22 0C	0C 19	22 0E
0DE8	0C C5	D5 E5	F5 CD	FC 01
0DF0	CD 6E	0C F1	E1 D1	C1 10
0DF8	DF CF	00 00	00 00	00 00

Figure 8.

Figure 3. Nascom I/Creed 75 interface.

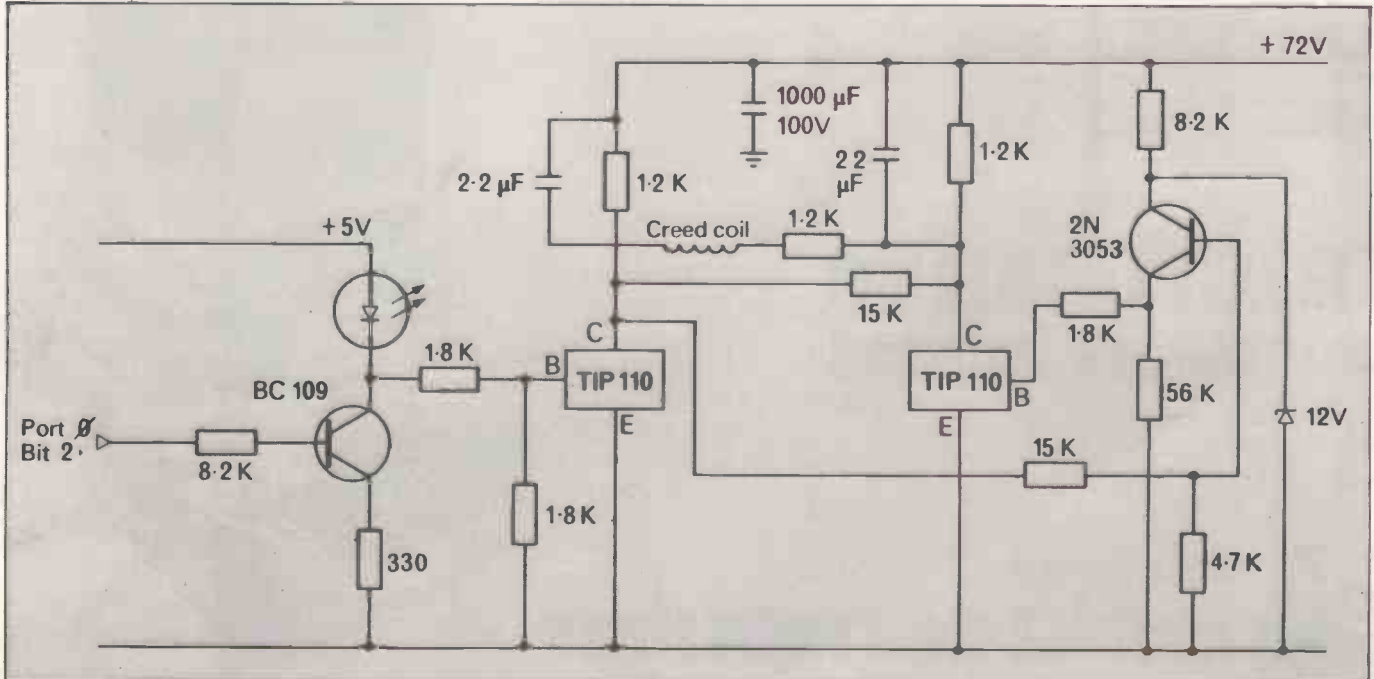

Apple Price List

Product Code	Description	Price (£)	Product Code	Description	Price (£)
HARDWARE			DOCUMENTATION		
A2S1016P	APPLE 16K VIDEO OUTPUT ONLY	695.00	A2L001A	APPLE II REFERENCE MANUAL	11.00
A2M0003	DISC DRIVE WITHOUT CONTROLLER	299.00	A2L0002	6502 HARDWARE MANUAL	9.00
A2M0004	DISC DRIVE WITH CONTROLLER	349.00	A2L0003	6502 SOFTWARE MANUAL	9.00
A2M0016	16K ADD ON RAM	69.00	A2L0005	APPLE II BASIC PROGRAM MANUAL	6.00
CARDS & ACCESSORIES			A2L0006	APPLE II REFERENCE MANUAL	6.00
A2B0001	PROTOTYPE/HOBBY CARD	15.00	A2L0012	DOS 3.2 MANUAL	6.00
A2B0002	PARALLEL PRINTER INTERFACE CARD	104.00	A2L0018	APPLE II BASIC TUTORIAL MANUAL	6.00
A2B0003	COMMUNICATIONS CARD	130.00	GENERAL ACCESSORIES		
A2B0005	HIGH SPEED SERIAL INTERFACE CARD	113.00	A2D0000	(10) BLANK APPLE DISCETTES	32.40
A2B0006	PASCAL LANGUAGE SYSTEM	299.00	A2M0009	VINYL CARRYING CASE	16.00
A2B0007	CENTRONICS CARD	130.00	AD/LB	MINI DISC LIBRARY BOX	2.64
A2B0009	APPLESOFT FIRMWARE CARD	116.00	MD5172	DISCOFLEX FILING CASE--MINI	12.64
A2B0010	INTEGER CARD	116.00	APP1	APPLE DESK TWO TIER	145.00
MHP-X003	MOUNTAIN HARDWARE CLOCK/CALENDAR CARD	160.00	APP2	PRINTER TABLE	92.00
MHP-X006	MOUNTAIN HARDWARE SUPERTALKER	171.00	APPLETEL	APPLETEL SYSTEM	595.00
MHP-X007	MOUNTAIN HARDWARE ROM PLUS BOARD	116.00	DUST/APP	DUSTCOVER FOR APPLE II	5.35
MHP-X015	MOUNTAIN HARDWARE ROMWRITER	101.00	E2B013	APPLEJUICE RESERVE POWER SUPPLY	148.00
E2B100	EUROCOLOUR CARD	79.00	PRINTERS & ACCESSORIES		
E2B101	APPLE BLACK & WHITE MODULATOR	14.00	A2M0034	SILENTYPE 80 COLUMN GRAPHICS PRINTER	349.00
E2B102	A1-02 DATA ACQUISITION CARD	180.00	A2C0001	10 ROLLS OF THERMAL PAPER FOR SILENTYPE PRINTER	28.00
10-5-16	ALF MUSIC SYNTHESIZER CARD	142.00	HUSH100/A	MICROHUSH 100 PRINTER C/W APPLE INTERFACE	266.00
10-5-17	ALF TIMING MODE INPUT BOARD	14.00	HUSHPAP	16 ROLLS THERMAL PAPER 80FT LONG	22.00
13-3-2	ALF ALBUM MUSIC DISKETTE NUMBER ONE	12.00	HUSHPAP/E	2 ROLLS THERMAL PAPER 80FT LONG	5.00
13-3-4	ALF ALBUM MUSIC DISKETTE NUMBER TWO	12.00	TIGER/G	PAPER TIGER PRINTER WITH GRAPHICS OPTION	598.00
13-5-5	ALF ALBUM MUSIC DISKETTE CHRISTMAS	12.00	TIGER/C	CONNECTOR CABLE FOR TIGER PRINTER	9.00
A2M0015	HEURISTICS SPEECH LAB	122.00	TIGER/D	GRAPHICS SOFTWARE FOR TIGER PRINTER	20.00
A2M0019	PROGRAMMERS AID 1	27.00	TIGER/P	TIGER PAPER 2,000 SHEETS 11" x 9 1/2" S/PART	35.92
A2M0027	AUTO START ROM PACK	38.00	TI810	TEXAS OMNI 810 PRINTER	1450.00
A2M0029	GRAPHICS TABLET	462.00	LP5	PAPER 2000 SHEETS 11" x 15" S/PART	14.06
E2B104	HEURISTICS CONTROLLER 70	52.00	LP9	PAPER 3000 SHEETS 8" x 12" S/PART	14.85
E2B105	HEURISTICS SPEECHLINK 2000	160.00	VIDEO MONITORS		
E2B107	IEEE INTERFACE	212.00	VM129	12" BLACK AND WHITE VIDEO MONITOR	189.00
SOFTWARE			VM910	9" BLACK AND WHITE VIDEO MONITOR	127.00
A2D0005	CONTRIBUTED SOFTWARE VOLS 3-5	60.00	VM906	9" HIGH RESOLUTION BLACK AND WHITE VIDEO MONITOR	148.00
A2D0006	CONTRIBUTED SOFTWARE VOLS 1-2	27.00	VM/C	CABLE FOR VIDEO MONITOR	9.00
A2D0009	MICROCHESS 2.0 CHESS DISK	15.00			
A2D0010	DISC UTILITY PACK	15.00			
A2D0012	APPLE BUSINESS CONTROLLER PROGRAM	340.00			
A2D0013	APPLE POST PROGRAM	27.00			
A2D0018	APPLE BOWLING DISCETTE	9.00			
A2D0025	APPLE CASHIER PROGRAM	194.00			
A2D0026	APPLE WORD PROCESSING PROGRAM	42.00			
A2T0013	MICROCHESS 2.0 CHESS CASSETTE	15.00			
E2D001	VISICAL.C DISC & BOOK COMPLETE	95.00			

Prices exclusive of carriage and VAT and are correct at time of going to press. Available from Apple Dealers all over the UK—for your nearest please contact Microsense Computers. Dealer/OEM enquiries welcome.

microsense computers limited

Finway Road, Hemel Hempstead, Herts HP2 7PS
Tel (0442) 48151 and 41191
Telex: 825554 DATEFF G

106



SOLE UK DISTRIBUTOR

apple computer

Apple is a trade mark of Apple Computer Inc., Cupertino, C.A., USA

• Circle No. 179



(continued from page 105)

to 00H and BC is added to HL. For characters printed on the Creed or used to control the machine the resulting value will lie between 0D2D and 0D8F, the look-up table is situated in this area of memory. The value from the table is loaded into 0C57 for temporary storage.

The remainder of the character output routine is straightforward and is illustrated by the flowchart. The figures/letters shift subroutine at 0DA0 is bypassed if bit 6 of the CCITT code is set, saving time for space and line feed characters. The construction of a look-up byte and flowchart for this routine is shown in figure 6.

Program variables

A flowchart for the program section that prints a line is displayed in figure 7 and variables for the complete program are set-out in table 1. Note, the number of lines to be printed is decremented before the output of the first line is started; if the whole screen of 16 lines is to be printed 0C83 should be set to 11 Hex — 17 Decimal.

The subroutine at 0D90 causes a carriage return to be executed which is

Figure 6. Figures/letters shift routine.

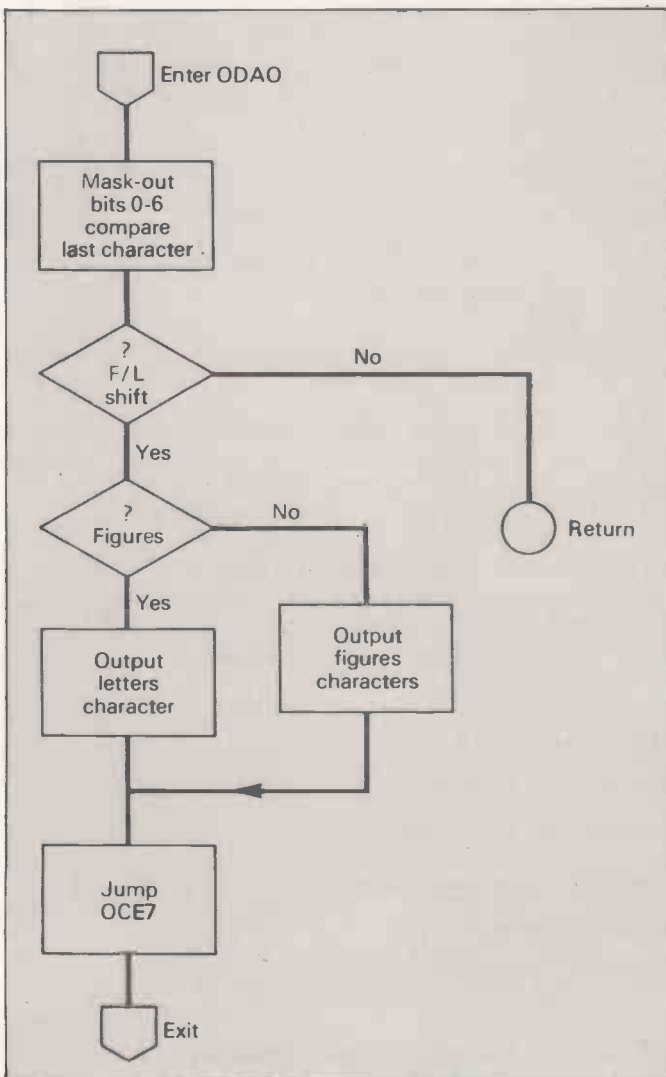

0C50	Top-left reference
0C52	Current left margin
0C54	Current right margin
0C56	Last character
0C57	Current character
0C58	Number of lines to print
0C5B	Multiple page tabulate reference
0C5D	Current page start tabulate address
0C83	Number of lines + 1
0DD7	Number of screens to print

followed by a short delay of approximately 80mSecs so that the type head or carriage can reach its resting position before the next character is sent.

The program is normally executed at 0C6A. That calls the routine to output the current information on the VDU and returns to the monitor. A routine at 0DD0 tabulates a section of memory starting from the value set in 0C5B plus 68H on to the screen, prints the screen, and loops to continue the process. 0C5B — 0C5C should be modified to E8 — 0B to start printing at 0C50. The line number reference (0C83) should be set to 0EH to obtain a continuous print, the object code listing — figure 8 — was printed in this way.

Creed teleprinters are not 45 cps, bi-

Figure 7.

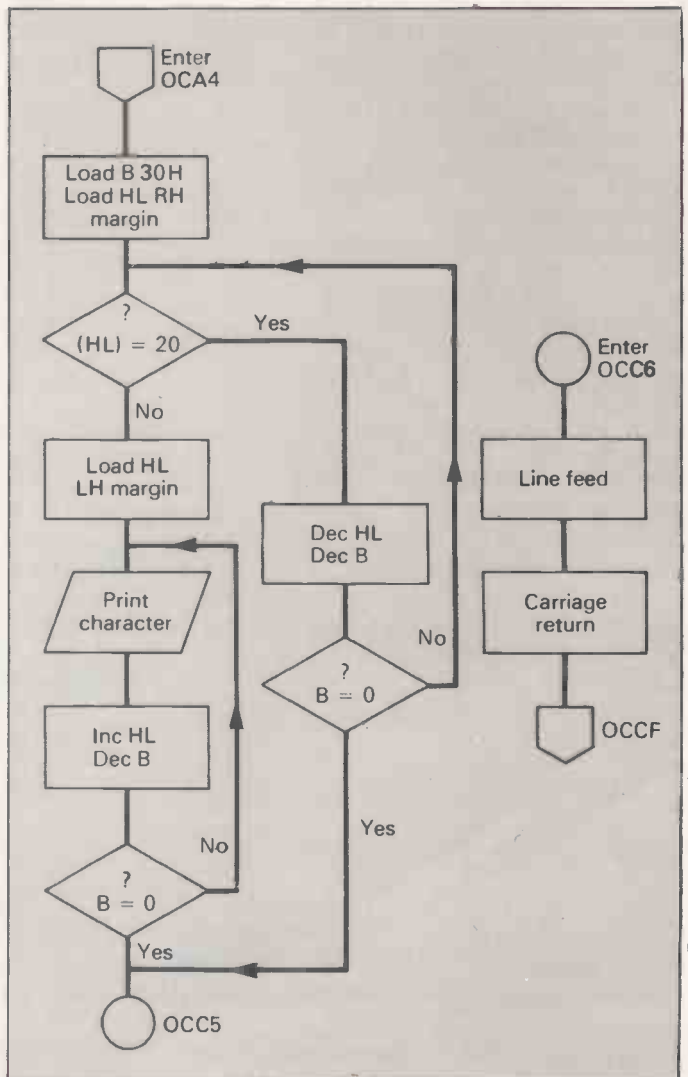

directional, correspondence-quality printers with associated proportional-spacing software. At worst, the machine prints a shift character before each character which appears on paper, object code listings often approach this condition as there are many figure/letter combinations in the machine-code instructions. In such a case, the print speed will be nearly halved and will approximate to four characters per second.

Extremely useful

On the other hand, the program and printer produce results that are legible, reliable, very cheap and extremely useful. Program development becomes possible away from the Nascom; this program was disassembled to draw the flowcharts on a commuter train. The printer can be used to draw surprisingly-useful histograms and segments of the program can be incorporated into others to print the results of calculations or, for example, to plot changing analogue values. The program has been used as part of a crude word-processing package.

The ability to obtain an accurate hard copy of an experimental program at the end of a session cannot be overestimated. □

the software house

146 OXFORD STREET, LONDON W.1.

To Order simply photostat this page & circle items required and send with your remittance. ALL PRICES INCLUDE 15% VAT where applicable.

PLEASE SEND THE FOLLOWING PROGRAMS FOR MY MICROCOMPUTER:—

APPLE (I = Integer A = Applesoft)		FOR APPLE/TRS 80 and SORCERER ADVENTURE!!!	
APPLETALKER (I)	£15.00	ADVENTURELAND	£10.00
APPLE LIS'NER (I)	£15.00	PIRATE ADVENTURE	£10.00
CITY MANAGER (A)	£ 9.00	MISSION IMPOSSIBLE	£10.00
STARWARS + SPACEMAZE	£ 9.00	VOODOO CASTLE	£10.00
APPLE 21 (I)	£ 9.00	THE COUNT	£10.00
MICROCHESS TAPE	£12.00	STRANGE ODYSSEY	£10.00
MICROCHESS DISC	£16.50	MYSTERY FUN HOUSE	£10.00
BRIDGE CHALLENGER (I)	£12.00	PYRAMID OF DOOM	£10.00
DOS 3.2 TUTOR (A)	£34.50		
MAIL LIST/LABEL (A)	£57.50	FOR APPLE OR TRS80	
STOCK CONTROL (A)	£80.50	* SORCERERS CASTLE	£ 8.50
VISICALC	£109.00	* KING TUT'S TOMB	£ 8.50
AIMS DATA BASE (A)	£140.00	* HOUSE OF 7 GABLES	£ 8.50
DATA BASE UTILITY (A)	£50.00	* JOURNEY/CENTRE OF EARTH	£ 8.50
FORTH	£40.00	(ALL 4 above on disk for)	£28.00
LISP	£34.50	ENCHANTED ISLE	£ 8.50
L. GENIUS APPLESOFT	£46.00	ATLANTIS	£ 8.50
L. ADVANCED APPLESOFT	£46.00		
KNOW YOURSELF	£ 6.00	TRS80	
SPACE GAMES	£ 6.00	ANDROID NIM	£ 9.00
SPORTS GAMES	£ 6.00	BEE WARY!	£ 9.00
STRATEGY GAMES	£ 6.00	LIFETWO	£ 9.00
CAI PROGRAMS	£ 6.00	SNAKE EGGS	£ 9.00
SPACE INVADERS	£12.00	THE GREAT RACE	£ 5.00
APPLE INVADERS	£13.80	LYING CHIMPS	£ 5.00
CONTRIBUTED V3/5	£69.00	OWLTREE	£ 5.00
REFERENCE MANUAL	£11.00	TRS80 OPERA	£ 5.00
HIRES CHAR. GENERATOR	£19.00	NEWDOS +	£49.50
SHAPE BUILDER	£19.50	MTREK	£ 8.00
MASTER CATALOGUE	£16.00		
STATISTICS	£23.00	PET	
DATESTONES OF RYN	£15.00	ENLARGE (DISPLAY)	£ 6.00
TEMPLES OF APSHAI	£26.00	TIME TREK	£12.00
WIZARDS MOUNTAIN	£ 9.00	DUCKSHOOT	£ 5.00
RELOCATED INTEGER (A)	£14.00		

This is just a selection from our software range — we have the widest range of software and are adding new items daily. Send for our FREE catalogue.

NEW — APPLE UTILITIES DISC — single disc copy, patch zap etc. £19.50.

BUSINESS APPLICATIONS CONSULTANCY: we can offer help & advice — we specialise in the APPLE/ITT and offer tailored programs, complete systems and advice.

Send for details of our unique PROGRAMMERS COURSE & WORKSHOP (APPLE).

We also distribute the 80-US JOURNAL — a SUPERB magazine for the TRS80 £14.00 p.a.

Programs are in development for the SHARP and most popular micros.

If you don't see what you require — please ask — we regularly import the latest programs from most sources.

NAME..... MICROCOMPUTER.....
 ADDRESS..... TOTAL FOR PROGRAMS £
 (orders under £15.00 p&p 50p)

 Cheque/P. Order/Cash enclosed.....

For 80-US subscription tick here

Items over £20.00 in value are sent by recorded delivery.
 We welcome outside programs — our standard royalty is 15%.

The Softwarehouse is next door to OXFORD WALK (between Oxford Circus and Tottenham Court Road) and is open Monday to Friday 9.30 am to 5.30 pm

• Circle No. 180

Suicide bombers

A GAME written in Applesoft by Simon Goodwin of Hereford demonstrates some of the exceptional graphics facilities of the Apple. It runs reasonably quickly and produces a picture of a black ship on a blue background, able to fire at a succession of small moving targets which dive towards it from random positions at random times.

The targets explode in a delicate shade of purple when hit and also when they crash into the superstructure of the ship. The program makes special use of the 'CALL 62454', which, after a 'HCOLOR = 2, turns the whole display blue.

From then on, instead of erasing each plot with HGR or HCOLOR=0, it need only be overdrawn in blue to achieve the desired result. The very convenient joint-points instruction is used to display the line of fire of the gun, and the similar-triangles formula in 300 is used to decide whether or not the fire passes through the target.

To achieve sufficient speed for a challenging game, multiple statements are used in the crucial lines 220 and 230. In fact, the program could be made still faster by replacing the constants on these lines with variables.

Objectives are to hit the enemy aeroplanes as early as possible, with the minimum expenditure of ammunition. By selecting a higher skill rating, it is made harder to hit each attacker — greater accuracy is required.

If you want to test the program, lines 0-99 and 500-590 are optional and it will run happily without them.

LIST

```

10 TEXT : HOME : PRINT "": REM
   CTRL G
20 PRINT "SUICIDE BOMBERS : A GU
   UDWIN GAME, 1980."
25 PRINT
30 PRINT "*****
   *****"
35 PRINT
40 PRINT : PRINT "YOU CONTROL TH
   E FIRE OF A SHIP AGAINST "
45 PRINT
50 PRINT "FIFTEEN ATTACKING SUIC
   IDE AIRCRAFT."
55 PRINT
60 PRINT "TURN #1 PADDLE AND PRE
   SS THE BUTTON "
65 PRINT
70 PRINT "TO FIRE AT THE PLANES
   BEFORE THEY HIT."
75 PRINT
80 PRINT "YOU MUST SAVE AMMUNITI
   UN AND HIT THE "
85 PRINT
90 PRINT "PLANES EARLY TO GET A
   GOOD SCORE."
95 PRINT : PRINT "PRESS ANY KEY
   TO START THE GAME.... ": GET
   A$: PRINT
99 REM ** SET UP **
100 TEXT : HGR : HCOLOR= 2: HPLOT
   0,0: CALL 62454:S = 500
110 HCOLOR= 0: HPLOT 120,148 TO
   132,140 TO 144,148
120 HPLOT 110,159 TO 90,148 TO 2
   79,148 TO 259,159
130 HPLOT 155,148 TO 160,141 TO
   230,141 TO 235,148
140 HPLOT 190,141 TO 190,132 TO
   204,132 TO 204,141
150 PRINT "SUICIDE BOMBERS : A G
   UDWIN GAME, 1980. "

```

This section is open to the Apple user. In every issue we hope to print ideas, hints and comments about the Apple and its suppliers. They must come from you, so write and tell us what you know.



```

160 INPUT "TYPE YOUR SKILL RATIN
   G (0-6) ":J:J = B - J
190 REM ** MAIN LOOP **
200 FOR X = 1 TO 15: PRINT "TARG
   ET "X:T = INT ( RND ( 1 ) *
   100 ) + .10
210 FOR D = 0 TO RND ( 1 ) * 1000
   : NEXT D
220 FOR V = 0 TO 140 STEP 4:H =
   T + V: HCOLOR= 1: HPLOT H,V TO
   H + 4,V: HCOLOR= 0:P = PDL
   ( 1 ): HPLOT P,0: IF PEEK ( -
   16286 ) > 127 THEN S = S - 23
   : GOTO 300
230 HCOLOR= 2: HPLOT P,0 TO 128,
   145: HPLOT H,V TO H + 4,V: IF
   Z = 1 THEN V = 200
235 NEXT V: IF V > 150 THEN PRINT
   TAB( 18 )"HIT!": GOTO 250
240 S = S - 100: HCOLOR= 6: HPLOT
   H,150 TO H + 1,140 TO H + 2,
   148 TO H + 3,142 TO H + 4,15
   0
250 PRINT "+++++ NEW SCORE
   "S":Z = 0: NEXT
   X
260 FOR D = 0 TO 1000: NEXT D
270 TEXT : HOME : PRINT "GAME OV
   ER.": PRINT
280 PRINT "YOU SCORED "S: INPUT
   "TYPE 0 TO END, ANY NO. TO P
   LAY "D: IF D < > 0 THEN CLEAR
   : GOTO 100
290 GOTO 400
295 REM ** GUNFIRE **
300 D = ( 159 - V ) / 159 * ( P - 12
   8 ) + 128
310 HPLOT P,0 TO 128,145
320 IF D < H OR D > H + J THEN P
   30
330 HCOLOR= 6: HPLOT H,V TO H +
   1,V + R TO H + 2,V + 2 TO H +
   3,V + 10 TO H + 4,V: S = S +
   200 - V
340 HCOLOR= 2: HPLOT H,V TO H +
   1,V + R TO H + 2,V + 2 TO H +
   3,V + 10 TO H + 4,V:Z = 1: GOTO
   230
400 HOME : END
500 REM ** VARIABLES **
510 REM A$=REPLY
520 REM D=GENERAL PURPOSE
530 REM H='X' COORD.
540 REM T=START POSITION
550 REM V='Y' COORD.
560 REM X=TARGET COUNT
570 REM Z=HIT NOTE
580 REM CTRL G IN 235
590 REM S.N.GUDDWIN, 12.3.80

```

Graphic illustration

IN MY very early days of programming, writes Frank Atkinson of Gateshead, Tyne and Wear, when anything was possible if you had the knowledge, I had the idea of producing a tabular illustration of some monthly totals. How neat it would be, I thought, if I could persuade my Apple and its printer to provide a simple

illustration after the entry of 12 figures.

The problem proved more difficult than I had envisaged. At first, I struggled trying to codify the input figures into horizontal lines to be printed sequentially. Then suddenly all was light — all you do is a regular sift and if the figure you have next is the appropriate one, you print some mark e.g., "xxxx". If not, you print an equivalent space " ".

The secret really lies in the use of the semicolon which permits sequential printing along the print line. In lines 350 to 380, X(M) is the figure, suitably scaled-down (by line 160), which is relevant for month M. If that figure is less than, or equal to Q and Q is the vertical axis, we print "xxxx".

If X(M) is greater than Q, then an equivalent space " " is printed. Note especially the semicolon on line 360, which is followed by a colon to permit use of GOTO. Also a semicolon on line 370. The PRINT of line 390 is necessary to stop all that and to force a new printed line to be started for the next value of Q.

```

3
3LIST
0 REM *****
1 REM *
2 REM * GRAPH PLOT *
3 REM * * * *
4 REM * COPYRIGHT *
5 REM * FRANK ATKINSON *
6 REM * 1980 *
7 REM *
8 REM *****
60 DIM M$(12),X(12),F$(12)
70 D$ = CHR$(4):L$ = CHR$(12)
80 DATA "JANUARY","FEBRUARY","MARCH",
"APRIL","MAY","JUNE","JULY","AUGUST",
"SEPTEMBER","OCTOBER","NOVEMBER","DECEMBER"
90 FOR M = 1 TO 12: READ F$(M): NEXT
100 FOR M = 1 TO 12: READ M$(M): NEXT
110 DATA "JAN","FEB","MAR","APR",
"MAY","JUN","JUL","AUG","SEP","OCT","NOV","DEC"
120 INPUT "ENTER THE YEAR TO BE RECORDED "Y:Y
130 PRINT "ENTER TOTAL VISITORS FOR THE MONTH OF "
140 FOR M = 1 TO 12
150 PRINT M$(M): INPUT R
160 X(M) = 30 - ( INT ( R / 3333 ) )
170 NEXT
210 Z$ = "*****"
220 PRINT D$ "PR12"
240 PRINT "MONTHLY ATTENDANCES FOR "Y:Y" ("0000"
250 PRINT "*****"
260 PRINT : PRINT
280 FOR Q = 1 TO 30
290 IF Q = 1 THEN PRINT "100 I "": GOTO 350
300 IF Q = 7 THEN PRINT "80 I "": GOTO 350
310 IF Q = 13 THEN PRINT "60 I "": GOTO 350
320 IF Q = 19 THEN PRINT "40 I "": GOTO 350
330 IF Q = 25 THEN PRINT "20 I "": GOTO 350
340 PRINT " I "":
350 FOR M = 1 TO 12
360 IF X(M) < Q THEN PRINT Z$(Q): GOTO 380
370 PRINT " "
380 NEXT
390 PRINT
400 NEXT
410 PRINT "*****"
420 PRINT " "
430 FOR M = 1 TO 12: PRINT M$(M) " "
440 NEXT
450 PRINT L$:D$: "PRLO"
460 END

```

Program naming

HAVING enjoyed the program-naming facilities offered on the Pet, I have often wished for such facilities for the Apple. As a result, I have written the following machine-code (6502) routines.

To use the routines type-in the routines from Hexadecimal values £02FD to £03FA. Due to the limitations of my typewriter, I have had to use the following: £ = dollar, used to represent Hexadecimal numbers. @ = hash, used to represent the immediate mode.

Having typed them into your Apple —

(continued on next page)

(continued from previous page)

if you are not sure how, see page 68 of the Apple II reference manual — save them by using the monitor WRITE command:

* 2FD.3FAW (RETURN)

Once saved to tape, or BSAVED to file on diskette, they may be loaded by

* 2FD.3FAR (RETURN) or BLOAD (Filename) from diskette

Note, if disc operating system is in use, the routines must be re-located, since they reside in page three of memory.

To save a program under a name, enter integer Basic — the routines do not work for Applesoft — with a CONTROL B RETURN. You may now either write a program or else load a program using the standard LOAD method. When you are ready to save your program, hit re-set or do a CALL-151. The monitor asterisk should appear. Then type in:

* Y_cW???? (RETURN)

Before you hit return, press play and record on your tape deck. The Y_c stands for CONTROL Y — if you do not know what it does, see page 70 of the Apple II reference manual.

Immediately following the control Y is the letter "W" for WRITE. It is followed by five letters or numbers of your choice which will be the program name. There should be a short pause after you hit return, a beep from the speaker, and the screen should clear. The top line should read

OUT:????

where ????? is the name.

There will be another pause and another beep at which time the cursor will return with something similar to

*38F— A = FD X = 00 Y = 00 P = B1 S = EE

Your program is now saved under the name ?????. You may now do a CONTROL C to return to your program, or repeat the procedure.

To load a program, be sure the routines are in memory. Do a control B RETURN to set the pointers, and hit re-set or type CALL-151 from Basic.

Then type

* Y_cR???? (RETURN)

Press play on your tape before hitting return. That is type CONTROL Y followed immediately by R for READ, and the program name. Note as with the W in the save routine, the R must follow immediately the CONTROL Y.

The read routine compares only the first letter of your input name to the first letter of each program name encountered. Hence, if you try to load a program saved under the name TRAIN, and the routines encounter the program TEST1 first, TRAIN will be loaded instead of TEST1.

When you hit return the cursor disappears, there is a beep from the speaker, and the screen clears. The top line should read:

I:????

where I stands for IN.

There will be another pause, then a beep. If the first letter of your input name matches with that of a found program, that program will be loaded or it will be

ignored and the routines will continue through the tape until the appropriate program is finally, if ever, encountered.

Once your program is loaded type CONTROL C RETURN to get into Basic, and your program should be waiting for you.

These programs may not work on the ITT 2020. Do not record speech or anything between saved programs as it will interfere with the routines. If a load error occurs, the routines will end and you will have to start again.

Listing 1

£02FD-	4C 8D 03	JMP	£038D	366-	8D 02 04	STA	£0402
300-	AD 01 02	LDA	£0201	369-	A9 FA	LDA	@£FA
303-	C9 D7	CMP	@£D7	36B-	8D 03 04	STA	£0403
305-	F0 05	BEQ	£030C	36E-	AD 02 02	LDA	£0202
307-	C9 D2	CMP	@£D2	371-	8D 04 04	STA	£0404
309-	F0 F2	BEQ	£02FD	374-	AD 03 02	LDA	£0203
30B-	00	BRK		377-	8D 05 04	STA	£0405
30C-	A5 CA	LDA	£CA	37A-	AD 04 02	LDA	£0204
30E-	85 05	STA	£05	£037D-	8D 06 04	STA	£0406
310-	A5 CB	LDA	£CB	380-	AD 05 02	LDA	£0205
312-	85 06	STA	£06	383-	8D 07 04	STA	£0407
314-	A5 4C	LDA	£4C	386-	AD 06 02	LDA	£0206
316-	85 07	STA	£07	389-	8D 08 04	STA	£0408
318-	A5 4D	LDA	£4D	38C-	00	BRK	
31A-	85 08	STA	£08	38D-	A9 00	LDA	@£00
31C-	A9 09	LDA	@£09	38F-	85 3D	STA	£3D
31E-	85 42	STA	£42	391-	85 3F	STA	£3F
320-	A9 00	LDA	@£00	393-	A9 05	LDA	£05
322-	85 43	STA	£43	395-	85 3C	STA	£3C
324-	A9 02	LDA	@£02	397-	A9 13	LDA	@£13
326-	85 3C	STA	£3C	399-	85 3E	STA	£3E
328-	85 3D	STA	£3D	39B-	20 FD FE	JSR	£FEFD
32A-	85 3F	STA	£3F	39E-	AD 02 02	LDA	£0202
32C-	A9 0C	LDA	@£0C	3A1-	C5 09	CMP	£09
32E-	85 3E	STA	£3E	3A3-	D0 04	BNE	£03A9
330-	20 2C FE	JSR	£FE2C	3A5-	A9 40	LDA	@£40
333-	A9 05	LDA	@£05	3A7-	85 04	STA	£04
335-	85 3C	STA	£3C	3A9-	20 58 FC	JSR	£FC58
337-	A9 00	LDA	@£00	3AC-	A9 C9	LDA	@£C9
339-	85 3D	STA	£3D	3AE-	8D 00 04	STA	£0400
33B-	85 3F	STA	£3F	3B1-	A9 FA	LDA	@£FA
33D-	A9 13	LDA	@£13	3B3-	8D 01 04	STA	£0401
33F-	85 3E	STA	£3E	3B6-	A5 09	LDA	£09
341-	20 CD FE	JSR	£FECD	3B8-	8D 02 04	STA	£0402
344-	A5 CA	LDA	£CA	3BB-	A5 0A	LDA	£0A
346-	85 3C	STA	£3C	3BD-	8D 03 04	STA	£0403
348-	A5 CB	LDA	£CB	3C0-	A5 0B	LDA	£0B
34A-	85 3D	STA	£3D	3C2-	8D 04 04	STA	£0404
34C-	A5 4C	LDA	£4C	3C5-	A5 0C	LDA	£0C
34E-	85 3E	STA	£3E	3C7-	8D 05 04	STA	£0405
350-	A5 4D	LDA	£4D	3CA-	A5 0D	LDA	£0D
352-	85 3F	STA	£3F	3CC-	8D 06 04	STA	£0406
354-	20 CD FE	JSR	£FECD	3CF-	A5 05	LDA	£05
357-	20 58 FC	JSR	£FC58	3D1-	85 3C	STA	£3C
35A-	A9 CF	LDA	@£CF	3D3-	85 CA	STA	£CA
35C-	8D 00 04	STA	£0400	3D5-	A5 06	LDA	£06
35F-	A9 D5	LDA	@£D5	3D7-	85 3D	STA	£3D
361-	8D 01 04	STA	£0401	3D9-	85 CB	STA	£CB
364-	A9 D4	LDA	@£D4	3DB-	A5 07	LDA	£07
				3DD-	85 3E	STA	£3E
				3DF-	85 4C	STA	£4C
				3E1-	A5 08	LDA	£08
				3E3-	85 3F	STA	£3F
				3E5-	85 4D	STA	£4D
				3E7-	20 FD FE	JSR	£FEFD
				3EA-	A5 04	LDA	£04
				3EC-	C9 40	CMP	@£40
				3EE-	F0 03	BEQ	£03F3
				3F0-	4C 8D 03	JMP	£038D
				3F3-	A9 00	LDA	@£00
				3F5-	A5 04	STA	£04
				3F8-	00	BRK	
				3F8-	4C 00 03	JMP	£0300

PO Box 2
St Neots
Cambridgeshire

Dear Sir

The benefits of word processing are here for all!

The **Comart VDM** Video Display Module plugs easily into the North Star Horizon Computer S100 Bus and, together with the Comart Monitor and VDM *Star word processing software, provides the facilities of "instant display" word processing on a general purpose microcomputer.

Text may be entered, edited and standard paragraphs inserted with true upper & lower case display then rapidly printed in your chosen format.

The VDM transforms the Horizon into a valuable word processor yet change the diskette software and it resumes its role as a general-purpose Computer **Real Flexibility!**

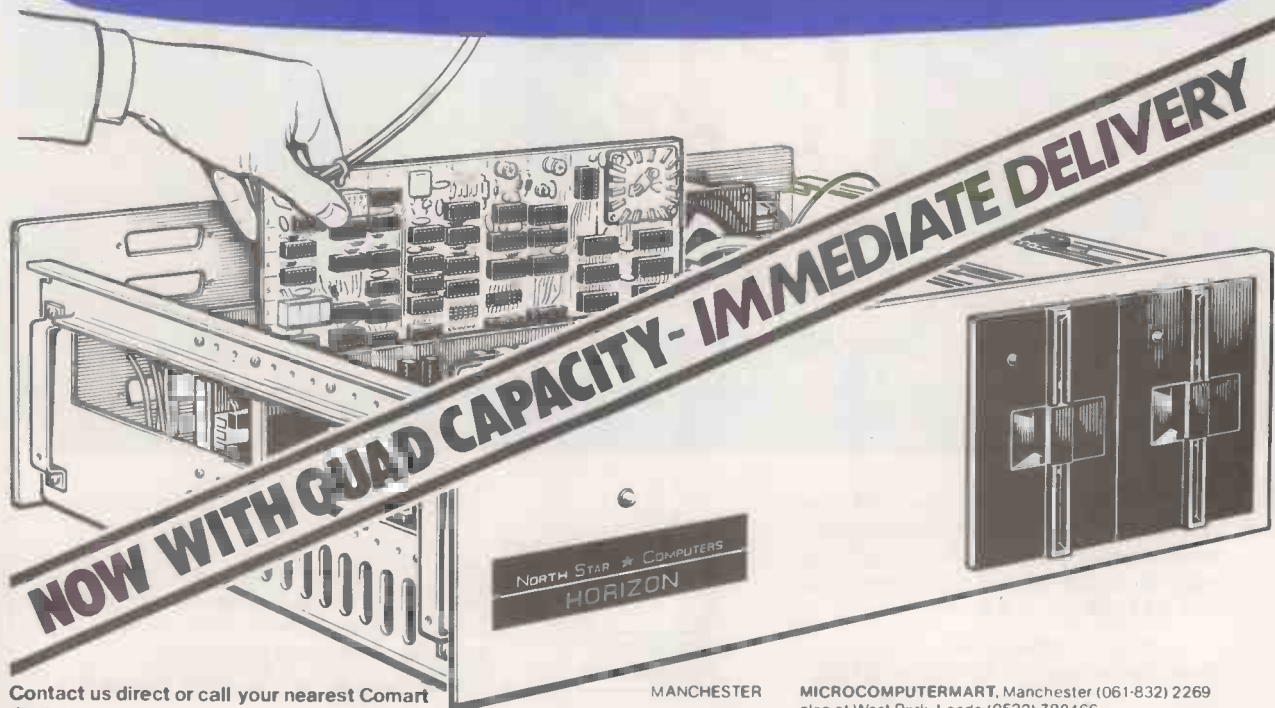

Contact us direct or call your nearest Comart dealer

CAMBRIDGE
CAMBERLEY
ILFORD

CAMBRIDGE COMPUTER STORE, Cambridge (0223) 68155
MICROBITS, Camberley, Surrey (0276) 34044
THE BYTE SHOP, Ilford, Essex 01-554 2177

LEEDS

also at Tottenham Court Road, London 01-636 0647
HOLDENE LIMITED, Leeds (0532) 459459

LONDON
LUTON

also at Wilmslow, Cheshire (0625) 529486
DIGITUS LIMITED, London W1 01-636 0105
ISHERWOODS, Luton, Bedfordshire (0582) 424851

MANCHESTER

MICROCOMPUTERMART, Manchester (061-832) 2269
also at West Park, Leeds (0532) 788466

NEWBURY

NEWBEAR COMPUTING STORE, Newbury, Berks (0635) 30505
also at Stockport, Cheshire (061-491) 2290

NEWPORT
NOTTINGHAM

MICROMEDIA SYSTEMS, Newport, Gwent (0633) 50528
COMPUTERLAND LIMITED, Nottingham (0602) 40576
also at Birmingham (021-622) 7149
Manchester 061-236 4737
Glasgow (041 332) 2468

SHEFFIELD
SOUTHAMPTON

HALLAM COMPUTER SYSTEMS, Sheffield (0742) 663125
XITAN SYSTEMS LIMITED, Southampton (0703) 38740



comart specialists in microcomputers

Comart Ltd., P.O. Box 2, St. Neots, Huntingdon, Cambs, PE19 2AF. Tel: (0480) 215005 Telex: 32514

• Circle No. 181

POWER!



NEW from Sybex!
A Step by Step Approach
Making Your Z.80 Work for You.

This comprehensive 624 page book includes an introduction to programming the Z.80 and all you need to know about programming and execution - £8.95

Also in this series, 'Programming the 6502' - £7.95

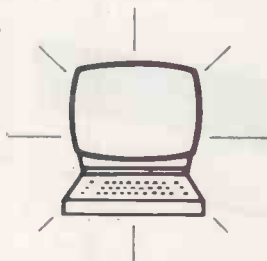

and '6502 Application' - £7.95

Get these invaluable books from your local computer store or book shop - now!
In case of difficulty, write or send cheque/postal order direct to:-

**The Computer
Bookshop**

Temple House, 43/48 New Street, Birmingham B2 4LH

Almost definitive

I WRITE concerning Mike Todd's final and definitive words on the RND function in Pet Corner, May. Unfortunately, they are not, writes Peter Drew of Nottingham.

The correspondence on RND seems to have concentrated on generating a different series of number each time. However, little thought seems to have been given to how those numbers are distributed.

For example, if continuous calls to RND(1) are made and the numbers are accumulated in 10 equal ranges, 0-0.1, 0.1 to 0.2 etc., it can be shown, using the statistical Chi-squared test, that the distribution is not truly random. Almost, but not quite. Here is one way of generating a random digit (F%). I am sure there are many others.

```
2000 F8 = STR$(RND(1)*LOG(TI))
2010 F% = VAL(MID$(F8,8,1))
2020 RETURN
```

It is slow but passes the Chi-squared test. Obviously, numbers of any size can be obtained by concatenation. The controversy continues unabated.

Delete routine

A DELETE routine for 8K Pet has been sent to us by Bill Short of Newcastle upon Tyne. The routine is entered by a statement such as:

```
100 SA=10: SP=5: EN=Z1:RS=110:
GOTO 9000
```

where SA is the initial line number to be deleted, SP the step, EN the number of lines and RS the line number to re-start the program.

The PRINT statement in 9000 bypasses the break-message return; 9001 prints-out eight line numbers to be deleted; 9002 saves the variables in line 8999 — which are otherwise set to 0 when RUN command is implemented.

Lines 9003 and 9004 continue the program and 9005 produces 10 RETURNS to delete or input statements producing instructions. REM statements may be deleted usefully while the program is running. The routine will also delete itself if 9003 is first deleted.

I have produced a similar program to that of C B Lake, Pet Corner, December, 1979 — instead of PEEK(515) and subsequent conversion problems, I found PEEK(525) gave me the correct location in the keyboard buffer (527-536) in which to find the value which could be POKEd on screen directly. Also POKE 224 and 225 will move the cursor more easily than using strings of cursor-control characters.

After producing the diagram or drawing, the program converts it to DATA statements which are entered with a routine similar to DELETE. The program then deletes itself leaving only the DATA statements which can be used to produce a diagram in another program — particularly useful to those in the teaching profession.

My compliments to all at *Practical Computing* — an excellent magazine. The



specialist columns are really useful and must greatly influence the development of microcomputing in the U.K.

```
8998 STOP:REM DELETE
ROUTINE 2-JW SHORT
9000 POKE 59409,228:
PRINT"QQQQ":IF EN=0
THEN9004
9001 FOR X=0 TO 7:
IF EN 0 THEN PRINT
SA:EN=EN-1:
SA=SA+SP:NEXT X
9002 PRINT"8999SA=";SA;"Q":
SP=";SP;"Q":EN=";EN;
"Q":RS=";RS
9003 PRINT"RUN8999":
GOTO 9005
9004 PRINT"POKE 59409,
60:RUN";RS
9005 PRINT"Q":POKE 525,0:
FOR X=1 TO 10:
POKE (526+X),13:
NEXT:POKE525,10:STOP
```

- Q=CLR
- Q=cursor down
- Q=cursor left
- S=home

Clock functions

THE PET has several built-in clock functions but, surprisingly, there are major problems in timing in the millisecond time region, writes Chris Smith from north London.

The processor-based clocks, fast clock at 59464/5, run asynchronously from the jiffy-based clocks, TI and TIS. The fast clock counts up to 64 milliseconds only.

Keyboard presses, an obvious way to stop and start the timer, are checked only once a jiffy, thus giving a ± 8 millisecond error on both start and stop.

The timer described in my article on microphysiology, *Practical Computing*, January, 1980, solved the first problem by using a two-byte, machine-code counter in 1/20 millisecond steps, but fell foul of the second problem.

A revised routine makes use of the chance that one of the keyboard sense lines is accessed directly by location 59410, old and new ROMs. I suppose that this sense line is direct because it includes the stop key. Store 59410 contains:

```
255 no key active
254 RVS
253
```

```
251 Space
247
239 Stop
223 ???
191
127 =
```

The program checks the store by incrementing by one, passing if zero, and otherwise storing the incremented value in location 1002 where it may be inspected by a BASIC PEEK(1002).

Line 125 contains the value to trim the delay loop. 197 gives a unit time on my Pet of 1 milliseconds ± .005.

Using a value of five gives a unit very close to 1/20 millisecond. The maximum time is 256 × 256 units, i.e., 65.536 seconds, or about 3.3 seconds when running at 1/20 milliseconds.

```
60 REM PEEK(1002) GIVES:
65 REM 128 FOR = 192 FOR
70 REM 252 FOR SPACE 255 FOR RVS
75 REM
100 DATA169,1 :REM LDA#1
105 DATA141,232,3 :REM STA 1000
110 DATA169,0 :REM LDA#0
115 DATA141,233,3 :REM STA 1001
120 DATA120 :REM SEI 197
125 DATA169,197 :REM LDA#
**TRIM
130 DATA170 :REM TAX
135 DATA202 :REM DEX
140 DATA208,253 :REM BNE -3
145 DATA24 :REM CLC
150 DATA173,18,232 :REM LDA 59410**
KEY
155 DATA105,1 :REM ADC#1
160 DATA208,10 :REM BNE +10
165 DATA238,232,3 :REM INC 1000
170 DATA208,3 :REM BNE +3
175 DATA238,233,3 :REM INC 1001
180 DATA208,232 :REM BNE -24
185 DATA88 :REM CLI
190 DATA141,234,3 :REM STA 1002
195 DATA96,999 :REM RTS END
200 L=826
210 READX:IFX<256THENPOKEL,X:L
=L+1:GOTO210
300 PRINT"Q PUSH KEY WHEN SCREEN
CLEARS"
305 PRINT"Q = FOR CORRECT":
PRINT" . FOR WRONG"
310 FORJ=1TO2000+3000*RND(1):NEXT:
PRINT"Q":GETAS:SYS(826)
315 AS="WRONG":IFPEEK(1002)=
128THENAS="RIGHT"
320 PRINT"YOU TOOK"(PEEK(1000)+
256*PEEK(1001)/1000) SEC TO
PUSH "AS
330 GOTO300
```

Anagram program

CROSSWORD enthusiasts and word-puzzle solvers should find the following short program useful, writes Malcolm Pritchard of Southport in Merseyside. Any group of letters may be entered and the various permutations will then be calculated and presented to the user. If an anagram is being solved and the positions of certain letters are already known, they may also be entered and the remaining letters will be re-arranged to fit the blanks. Depending on the number of unknown letters, it is a simple task to scan the output for the correct solution.

The type of word-puzzle in which some or all of the letters of a given word have to be re-arranged into as many different words as possible is also catered for. The

(continued on next page)

(continued from previous page)

length of the shortest new word can be entered as the starting point for output.

Although the program was written for the Commodore Pet, it should be suitable for other machines with Microsoft Basic available. CHR\$(147) in line 110 is the clear-screen, cursor-home character.

From a programming point of view, the most interesting feature is the method of producing the various permutations in lines 300-480. The obvious way to do that would be with a series of nested FOR . . . NEXT loops. Unfortunately, the number of loops required is not known until the letters to be re-arranged have all been entered.

To complicate matters further, the global nature of variables in Basic prevents the use of a subroutine to generate the desired series of FOR . . . NEXT loops directly. The solution is to simulate the loops and hold the loop variables in an array, Q(K). K indicates which loop is being executed at any one time.

The only limitation of the program appears when letters in the original word are repeated. The output will then contain certain permutations more than once.

```

100 REM ANAGRAM PROGRAM,
    MG PRITCHARD APRIL 1980
110 PRINT CHR$(147);TAB(15);
    "ANAGRAM"
120 PRINT TAB(15);"-----"
130 PRINT:PRINT
140 PRINT"TYPE ONLY THE
    LETTERS TO BE REARRANGED":
    INPUT A$
150 PRINT
160 L=LEN(A$)
170 INPUT"ARE ANY LETTERS
    KNOWN (Y/N)";Q$
180 IF LEFT$(Q$,1)="N" THEN 240
190 IF LEFT$(Q$,1)<>"Y"
    THEN 170
200 PRINT:PRINT"TYPE THE
    KNOWN LETTERS EG '-B--D-'":
    INPUTK$:W=L
210 T=0:FOR J=1 TO LEN(K$):
    IF MID$(K$,J,1)="-" THEN
    T=T+1
220 NEXTJ:IF T<>L THEN PRINT
    "ERROR":GOTO 200
230 GOTO 270
240 K$="":FORJ=1 TO L:K$=K$+"-":
    NEXT J
250 PRINT:INPUT"NUMBER OF LETTERS
    TO BEGIN";W
260 IF W<1 OR W>L OR W<>INT(W)
    THEN PRINT"ERROR":GOTO 250
270 DIM B$(L),C$(L),Q(L)
280 PRINT:PRINT
290 GOSUB 500
300 FOR J=W TO L
310 K=1
320 Q(K)=1
330 IF B$(Q(K))=""
    THEN 440
340 C$(K)=B$(Q(K)):B$(Q(K))=""
350 K=K+1
360 IF K<=J THEN 320
370 A=1
380 FOR S=1 TO LEN(K$)
390 IF MID$(K$,S,1)="-"THEN PRINT
    C$(A);:A=A+1:GOTO 410
400 PRINT MID$(K$,S,1);
410 NEXT S:PRINT,
420 K=J
430 B$(Q(K))=MID$(A$,Q(K),1)
440 Q(K)=Q(K)+1
450 IF Q(K)<=L THEN 330
    
```

```

460 K=K-1
470 IF K>=1 THEN 430
480 NEXT J
490 END
500 FOR N=1 TO L
510 B$(N)=MID$(A$,N,1)
520 NEXT N
530 RETURN
    
```

An anagram is one of a set of N!, factorial, permutations of a group of letters which gives a clue to solving the problem. Visualise a serial number for each anagram in the range 1 to N!. The trick is how to code this number. Normal decimal is to the base 10,10,10,10 or binary 2,2,2 or yards, feet and inches 3,12. The coding for a factorial for anagram purposes is to the base of 5,4,3,2,1.

APL helps here as there are functions (TI) of encode and decode which allow exactly for problems like the odd base numbers. The problem is not very difficult in Basic.

- Set-up a counter vector P0.
- Increment the last element and test it P(N)>0.
- Transmit a carry if true.
- Test the next P(N-1)>1 etc., until the carry exhausts.
- If the carry does not exhaust, exit from the program.
- The vector now contains a set of pointers to the word.
- Extract the bytes one by one, shrinking the source word and adding to a new anagram.
- Print the anagram.
- Go back to incrementing the counter.

The organisation is similar to that used to extract the determinant of a matrix by the method of minors which also uses a factorial structure. The two methods have one thing in common — they are very slow. To print all the anagrams for a 20-byte word would take 1.11×10^{11} years, i.e. longer than the current age of the universe.

Everyone seems to agree that trying to solve a 20-character anagram poses insurmountable problems. The solutions for smaller words do, however, point us in the right direction. The next problem is to try and devise some simple rules to sort some of the nonsense words.

Short answer

S H BINNS of Hull has sent us a short, six-line anagram program, written in Pet Basic. Also enclosed are details of the mode of action, he writes. A few minutes on your office micro could have yielded the solution.

I am a home user of a Pet and have some experience of scientific programming over the last 10 years using Basic and Fortran. Recently, I have been using APL which gives a completely new insight into programming and handles problems like this very easily.

```

6Ø DIM P(5Ø):
    INPUT"WORD";
    W$:N=LEN(W$)
1ØØ I=N-1:
    
```

```

    WD$="**"+W$
11Ø IF I<Ø THEN END
12Ø P(I)=P(I)+1:
    IF P(I)>N-I-1
    THEN P(I)=Ø:
    I=I-1:GOTO 11Ø
14Ø AG$="":FOR I=Ø TO
    N-1:AG$=AG$+MID$
    (WD$,P(I)+3,1)
15Ø WD$=LEFT$(WD$,P(I)+2
    +MID$(WD$,P(I)+4):
    NEXT:PRINT AG$:
    GOTO 1ØØ
    
```

Note, the string "****" is a dummy to prevent the LEFT\$(argument becoming zero.

Pet talks

IT USED to be that the greatest competitor of the Pet was the Tandy TRS-80, writes Julian Allason. While Tandy still sells a good deal, especially in the States, the contest is beginning to look like Pet v. The Rest and Pet appears to be winning.

There is certainly more home-grown software for the Pet than for all the other systems put together, if one excludes CP/M. Many universities and industrial research departments have adopted Pet as their standard computer. Talking to a director of ICI recently, I mentioned the Pet: "Yes I have got some of those at my plant", he said. "About 150".

Dr Michael Brinson's computer-aided design of electronic circuits packages are an example of the increasing acceptance of the Pet in the big, computer world. So far there are two such packages: AC circuit analysis and DC circuit analysis, both costing £50 from Commodore dealers and Petsoft.

Circuit components, their value and connection, are keyed-in, in response to questions on the screen. The program then simulates the circuit described and can be used to analyse its performance.

The technique is used widely by professional engineers, but until recently such packages were available only for mainframes and minis and were priced accordingly. As with some of the business packages, mass computer ownership has encouraged software publishers to price professional quality software below £100.

Another sign of the general health of a computer system is the number of bolt-on improvements available. There is certainly no shortage of them for the Pet. One of the most useful, if you have a tendency to crash, is Aughton Automation's re-set kit.

If the screen starts printing 100s of pi signs, or the cursor vanishes when it shouldn't, press the re-set switch and you are back in business. Commodore calls it the hairpin method but it works.

One feature I miss on the Pet is auto-repeat on the keyboard. Kingston Computers, telephone 0262 73036, has produced a hardware repeat key costing £17.50 + VAT or £30 + VAT for the deluxe version. □



L&J COMPUTERS



3 CRUNDALE AVENUE, KINGSBURY NW9 9PJ 01-204 7525

THE "PET" SPECIALISTS

NEW LOW, LOW, 'PET' PRICES!!

Pet 8K (Large keys)	£420
16K	£499
32K	£630
Ext cassette decks (+ counter)	£ 55
PET Friction Feed printers	£450
AVAILABLE FROM STOCK +VAT	
Printers	Disc Drives
PET 3023	PET 3040
PET 3022	Compu 400K
Centronic 779	Compu 800K
Teletype 43	

**TRY US!
YOU WILL NOT BE
DISAPPOINTED**

Tool kits
Disks
Paper (roll & tractor feed)
Labels

WE HAVE ACQUIRED A REPUTATION FOR:

KNOWING WHAT WE ARE TALKING ABOUT.
HAVING A FIRST-CLASS BACK UP SERVICE.
KEEPING OUR WORD ON DELIVERY AND PRICE.
HAVING A VERY KEEN CASH & CARRY PRICE.
SUPPLYING SYSTEMS THAT SUIT THE JOB.



THE SYSTEMS WE SUPPLY & INSTAL ARE COMPLETE. ESTIMATES GIVEN FREE. WITH NO HIDDEN EXTRAS. FULL BACK-UP: GUARANTEED EXPERTISE.

PERSONAL SHOPPERS WELCOME
Phone & Mail Orders accepted.

SOFTWARE

As well as a full range of Petsoft and Commodore Software, we have some highly reliable "Home-Brewed" programs available.

STOCK CONTROL & INVOICING £60
(Handles up to 500 items — 32K) (180 on 16K). Stock depleted on invoicing, search etc. Cassette, disk (& print option).

STOCK TAKING £230
Basic program which can be tailored to suit most trades. Beautiful print-out!

OUTSIDE SERVICES (For Mini-Cabs Etc) £220
Weekly or monthly invoices — cheque writing facility — optional deductions. (16 or 32K + disk + printer).

MACHINE HIRE £420
Covers hiring of machines, customers, due & overdue. Hiring Charges: Machine History: Printouts for all Sections. Ideal for Typewriter & Plant Hire Firms.

CASH BOOK £90
Enter daily/weekly amounts — printout and totals, weekly/monthly analysis, totals and balances.

COMMODORE BUSINESS SOFTWARE & BRISTOL "TRADER" STOCKIST

SPECIALISED SOFTWARE APPLICATIONS UNDERTAKEN. RING FOR DETAILS

ALL GOODS SENT SAME DAY WHEREVER POSSIBLE
Recorded delivery by post: or Securicor. **



• Circle No. 183

Why get your PET from HSV

Because HSV are an established and expanding computing services company in operation since 1973, covering the mid-south area. We offer a full bureau service and microcomputers backed by systems advice, after-sales support, maintenance.

Our interest does not stop at the sale of a PET — HSV assure full back-up support:-

- in-house analysts and programmers
- our own engineers operating from 2 service centres
- a range of specialist systems for business, industry and education
- instruction manuals, programme cassettes,
- add-on equipment and all other supplies
- ACT Series 800 and ADDS System 75 microcomputers.

That's why!

HSV Limited, 22 Southampton Street, Southampton, Hants. Tel. (0703) 22131, and May Place, Basingstoke, Hants. Tel. (0256) 62444.

HSV

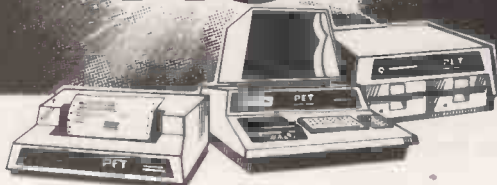

• Circle No. 184

AMAZING GAMES

PROGRAM LINE EDITOR

This month Amazing Games (the people who don't believe in Prاتفall programs) are talking about Utilities!

It isn't that we've gone off games, just that our new Program Line Editor is so good that we have to tell you about it!

You remember how much better things became when you started using the Autostart monitor, don't you?

Well, the Program Line Editor is an even bigger step up! Until now the Apple has been harder to use than some other machines, especially in writing programs, but now you can insert words into a line, or delete text, and when you've finished, hit return, even in the middle of a line!

The Program Line Editor not only allows you to edit supremely easily, but makes your machine much easier to run.

No longer need you see *** syntax error when you type 'CXATALKOGH' ... let the machine do it for you!!!

CUT HERE ----- CUT HERE

To: Amazing Games
Flat 3, 3 Green St., London W.1.

Please send me your latest catalogue (first half 1980)

Please mark your principal interest BUSINESS COMPUTING GAMES

YOUR NAME

ADDRESS

• Circle No. 185

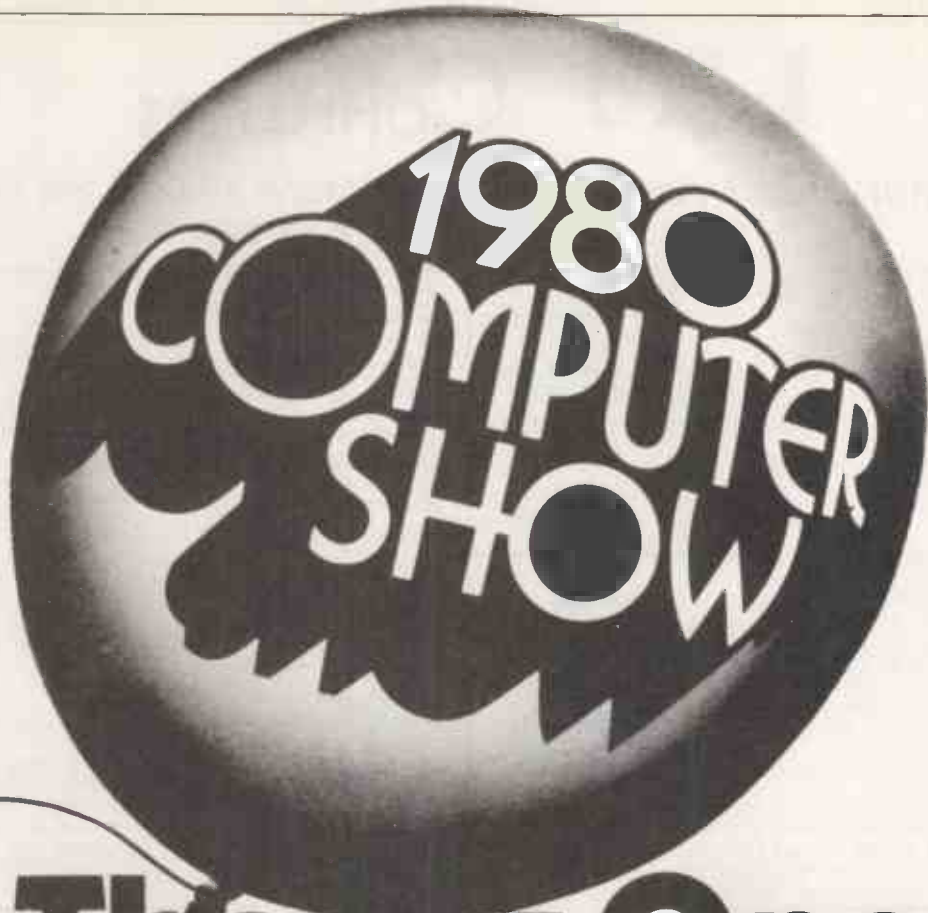

The Big One

See you at The Wembley Conference Centre
22-24 July, 1980

Last year's Show broke all records and made headline news in many newspapers. The 1980 Show with its comprehensive exhibition, international conference and one day seminars adds up to the most significant microcomputer event ever held.

Conference and Seminars

Please tick the topics which are of interest to you in the list below. To avoid disappointment you are advised to telephone your delegate registrations which will be accepted awaiting your written confirmation.

- | | |
|--|---------------------------------|
| <input type="checkbox"/> Microelectronic Applications
International Conference | Tuesday/Wednesday
22/23 July |
| <input type="checkbox"/> Microprocessors in Industry
Non-technical | Tuesday
22 July |
| <input type="checkbox"/> Micro Systems in Business
Non-technical | Wednesday
23 July |
| <input type="checkbox"/> Micros in Education
A special invitation to teachers
everywhere
Non-technical | Thursday
24 July |
| <input type="checkbox"/> "Future Computing"
by Dr. Portia Isaacson and Dr. Egil
Juliusen from the USA
- a seminar of interest to everyone in
the computer industry. | Thursday
24 July |

Exhibition Visitors Tickets

Admission to the exhibition will be by ticket only (£1.50 inclusive of VAT) available at the door.

Tickets are available from the Online Offices at a pre show price of £3.00 for 3 tickets (minimum). This offer closes on 15 July. All ticket requests must be accompanied by a cheque/postal order and suitable S.A.E.

I request _____ exhibition tickets at £3.00 for 3. (minimum 3 tickets). I enclose a stamped addressed envelope and remittance of £ _____

Name _____

Position _____

Organisation _____

Address _____

Online Conferences Ltd., Argyle House, Northwood Hills HA6 1TS
Telephone: Northwood (09274) 28211

PC

• Circle No. 186

Program merger

THE FOLLOWING programming tip, writes P C Inglis of Chelmsford in Essex, will enable you to merge a program located on a cassette with a second program located in memory, i.e., adding an already-recorded subroutine to a main program.

Make sure the program to be merged — the one on cassette — has line numbers larger than those of the program in memory.

Note the contents of location 16633 and 16634 using

```
PRINT PEEK (16633), PEEK (16634)
```

If the contents of 16633 is 2 or greater, do the following:

```
POKE 16548, PEEK (16633)-2:
POKE 16549, PEEK (16634)
```

If the contents of 16633 is 0 or 1, do the following:

```
POKE 16548, PEEK (16633) + 254:
POKE 16549, PEEK (16634)-1
```

CLOAD the program from the cassette, do the following:

```
POKE 16548, 233: POKE 16549, 66
LIST, RUN or CSAVE the merged program.
```

If you want to merge two cassette programs which have overlapping numbers and you do not have a re-number facility, enter the following line in command mode. It will add 32000 to all of your line numbers. Note, it will NOT update GOTO, gosub, THEN or ELSE statements, so you will have to do that yourself. The line is:

```
P = 17129: FOR L = 1 to 9000: IF PEEK (P + 1)
> 0 THEN POKE P + 3, PEEK (P + 3) + 125:
P = PEEK (P) + 256 * PEEK (P + 1): NEXT
```

The value 125 at the end of the third statement controls, in steps of 256, the increase in the line numbers, i.e., if it were changed to 50, all the line numbers would be increased by $50 * 256 = 12800$.

Tape protection

THIS SUBROUTINE is useful, writes Tim Abye from Winchcombe in Gloucestershire, when you have a program which uses cassette data files and you want to ensure that the user turns-off the recorder — the tape can be damaged if you leave the record or play keys down for a long time.

```
1000 print "please turn-off the recorder."
1010 if inp(255) and 64 then out 255,0 else out
255,8
```

```
1020 if inp(255) and 128 then return else 1020
```

Line 1010 re-sets the cassette input flip-flop, checking whether the video is in the 32- or 64-character-per-line mode, since the tape controller and the video-format controller are on the same output port.

Line 1020 keeps checking bit 7 of input port 255 until it goes high when it returns from the subroutine. That occurs when the stop key on the recorder is pressed.

Several programs have been published in Tandy Forum for de-bouncing the keyboard. The problem with all of them is that it is necessary to load them from cassette each time the computer is turned-on. A much better method is to fix the keys.

TANDY FORUM is devoted to the Tandy TRS-80. Sometimes we will use it to pass on news about the TRS-80 but, above all, it is for users, and would-be users, of the well-established model I and now the new model II. With your tips, queries, moans and comments, this page can become a market-place for TRS-80 information.



To do that, first remove the keyboard fascia, by prising it upwards with a screw-driver blade. Then pull-off the plastic key caps, starting with the shift keys and working inward, but do not try to remove the space key.

Some of the keys may need a strong pull but by easing them slowly, you should be able to remove them all. Clean each of the contacts by inserting a piece of stiff paper between the contacts, pressing the key down, and pulling out the paper while the contacts are still pinching it.

If you want to do a really thorough job, buy some contact cleaner — Tandy sells it for about £1 — and spray it into the con-

tact. Replace the keys — in the correct order — and the fascia.

Another problem is that which occurs occasionally when you have several separate lists contained in data statements and you want to go to the beginning of each list quickly without having to run through all the others.

The solution is to store the address of the beginning of each list in an array and when that particular list is needed, to poke the address into locations 16639-40.

The advantage of the method over that of searching through all the previous lists each time is that you need only one search. It is, therefore, much quicker.

The following program is an example, which, although not very useful in its present form, could be adapted.

```
10 dim hi(10),lo(10): on error goto 40:c = 0
20 read a$:if a$ < > "start" then 20
30 lo(c) = peek(16639):hi(c) = peek(16640):
c = c + 1:goto 20
40 resume 50
50 input "enter the number of the list you
want":n
60 poke 16639,lo(n):poke 16640,hi(n)
70 read a$:if a$ = "start" then 50 else print a$:
goto 70
```

The data statements can be placed anywhere in the program and the first item of each list should be the word start. If you type that word with the shift key held down and do the same with the two starts in the program, the program can distinguish between start as a data item and start as a list header.

Password subroutine

THIS SUBROUTINE, submitted by John Taylor, of Orpington, Kent, will stop the accidental breaking of a program operation. It will work only with the Basic resident in the computer; in disc Basic the poke is altered slightly. The poke, unlike POKE 16405,1, will allow the entry of alpha-numeric data, except for the break key which is disabled.

```
1 REM *****
2 REM P A S S W O R D P R O G R A M M E
3 REM *****
4 REM BY JOHN TAYLOR (CENTEC)
5 REM *****
6 REM
7 REM THIS PROGRAMME USES VARIABLES 'W', 'A$' AND 'I$'
8 REM
9 ' THIS PROGRAMME USES APPROXIMATELY 1K OF MEMORY WITH THE REM'S INCLUDED
10 CLS: CLEAR 100: POKE 16396, 23
11 ' THE POKE WILL DISABLE THE 'BREAK' KEY (BUT THE RESET KEY WILL STILL WORK)
20 A$ = "": GOSUB 30 : GOTO 20
24 REM SUB 30 IS THE ACCEPTER FOR THE PASS WORD
26 REM PLACE 'GOSUB 30' INTO YOUR PROGRAMME
30 CLS: I$ = INKEY$: IF I$ = "" THEN 40 ELSE RETURN
32 REM THE '#' IS THE FIRST PART OF THE PASS WORD
40 CLS: PRINT@0, "000": PRINT: FOR W=0 TO 3: GOSUB 70: NEXT W
41 REM THIS WILL PLACE THE "000" ON THE TOP LINE
50 IF A$ = "PASS" THEN POKE 16396, 25: END
61 REM THE POKE WILL RE-ACTIVATE THE 'BREAK' KEY
60 CLS: PRINT@460, "ACCESS DENIED IN LINE 60": FOR A=1 TO 1500: NEXT A: RETURN
70 I$ = INKEY$: IF I$ = "" THEN 70 ELSE A$ = A$ + I$: PRINT@W, "*" : RETURN
72 REM THIS WILL COVER THE '<>' WITH '*' ACCORDING TO
76 REM THE VALUE OF 'W' IN LINE 40
```

Computers? We'll help you pick and choose.



What are NSC Computer Shops?

NSC Computer Shops, based in Manchester and Leeds, are backed by years of computing expertise. We aim to offer a specialist computer service to schools, universities and colleges as well as small private concerns.

How can we help?

Are you thinking of becoming a first time computer user? Planning to expand existing facilities? Either way, at NSC Computer Shops we have all the specialist knowledge on systems and software and will be pleased to put you on the right track.

NSC Computer Shops' personal service doesn't end there either. Once the system to suit your needs is installed, we will continue to provide all the maintenance and back-up services you may need.

What sort of systems can NSC Computer Shops offer?

We can provide a comprehensive range of systems. From Cromenco's System Three and Z2 H to Pet and Apple. Most of them will be in stock. So, if you can, visit us today.

What about application software?

NSC Computer Shops can also provide a variety of application software to meet most of your requirements.

How can you find out more?

Fill in the coupon today. Or, contact one of our branches at:
MANCHESTER
29 Hanging Ditch, Manchester M4 3ES Telephone: 061-832 2269
or **LEEDS**
251 Otley Road, West Park, Leeds LS16 5LQ Tel: 0532 788466
(24 hours)



NSC COMPUTER SHOPS
Here to help

Please send me more information about NSC Computer Shops.

- * I will be a first time computer user
- * I'm expanding my existing system which, at present, comprises...

Name _____

Position _____

* Name of College/School/University/Business: _____

Address _____

Telephone _____

* Delete as appropriate

PC7

• Circle No. 187

Verification and Filler

THIS MONTH, I have two small programs written in assembler code, writes Walter Wallenborn. The first, by Laurie Lambert, is a verification program which compares two areas of memory. It is written for the SYM-1 but is transplanted easily to any other 6502. The main use for this kind of routine is when moving data or checking EPROMs against the data that should be in them.

The following details will help to transfer the routine to another machine. Monitor routines used are:

OUTBYT 82FA outputs accumulator in Hex.
COMMA 833A outputs ASCII for comma.
INCHR 8A1B gets character from keyboard.
WARM 8003 monitor warm-start.
CRLF 834D outputs CR and LF.

Before running, put high byte of stop address +1 in 0000, i.e., end address of data block 1 +1.

Addresses 0001 to 0004 contain data block 1 start address low, high followed by data block 2 start address low, high. Location 0005 contains SAVIT — temporary storage.

For example, to compare 0400-07FF to 1800-1BFF.

0000 = 08
0001 = 00
0002 = 04
0003 = 00
0004 = 18
0005 = Don't care

To start, use GO — OCOO. Any errors are displayed as data 1, data 2, data 1 address. Hit Q to exit or any key to continue.

The program is not optimised but works and is a good starting point. Two ways to improve it would be by trying to eliminate jumps where possible and by using the compare indirect addressed indexed by the Y register.

```

OC00 LOOP A000 LDY #0 START WITH 0 OFFSET
          B101 LDA (DATA1),Y LOAD INDIRECT ADDRESSED
          B505 STA SAVIT SAVE TO COMPARE
          B103 LDA (DATA2),Y
          C505 CMP SAVIT
          F017 BEQ OK BRANCH IF EQUAL
          20FA82 JSR OUTBYT PRINT DATA2
          203A83 JSR COMMA PRINT COMMA
          A505 LDA SAVIT LOAD DATA1
          20FA82 JSR OUTBYT PRINT DATA1
          20360C JSR FIND PRINT COMMA AND ADDRESS
          201B8A JSR INCHR WAIT FOR KEY
          297F AND #87F STRIP BIT 7
          C951 CMP #851 Q?
          F01D BEQ OK
          OK CE INY STEP TO NEXT PAIR
          D00A BNE OVER Y # 0
          E602 INC DATA1+1 HIGH BYTE + 1
          E604 INC DATA2+1
          A500 LDA STOP
          C502 CMP DATA1+1 FINISHED?
          F003 BEQ OUT YES
          OC30 OVER 4C020C JMP LOOP REPEAT
          OC33 OUT 4C0180 JMP WARM MONITOR WARM ENTRY
          OC36 FIND 203A83 JSR COMMA
          A502 LDA DATA1+1 CURRENT ADD HIGH
          20FA82 JSR OUTBYT PRINT HIGH ADDRESS
          98 TYA Y=CURRENT ADD LOW
          A8 TAY
          20FA82 JSR OUTBYT PRINT LOW
          204D83 JSR CRLF
          60 RTS
  
```

The second program is designed to fill memory with a byte called FILLER. This program, unlike the comparison one, is self-modifying and, therefore, must reside in RAM — the other could have been in EPROM.

The uses of the program include filling memory with \$FF so that with the previous program a cleaned EPROM may be checked. It would make a subroutine for checking memory with each bit pattern being loaded in turn and then checked. It is ideal for that job because it

THE 6502 SPECIAL is dedicated exclusively to the exchange of information between 6502 users. It is up to you, the reader, to help establish this page with your ideas, problems and guidance for other 6502 users. Please mark your letters 6502 Special. We pay £5 for each contribution published.

is so fast. Although it was written on the AIM-65, I located at the address for the Pet cassette buffer number 2.

```

<N>
ASSEMBLER
FROM=1000 TO=17FF
IN=M
LIST?Y
LIST-OUT=

OBJ?N
PASS 1

PASS 2

==0000
; THIS PROGRAM FILLS
; MEMORY WITH A VAR-
; IABLE CALLED FILLER
; IT FILLS IN 256
; BYTE BLOCKS. BLOCKS
; DETERMINES HOW MANY
; TO FILL AND START
; IS STORED IN THE SE
COND (HI) BYTE
; OF DUMMY ADDRESS
$8000

==0000
*=$033A
; TAPE #2 BUF ON PET.
; COULD BE ANYWHERE!
==033A
AD4F03 LDA FILLER
; GET FILLER CHAR
A200 LDX #0
; START X REG AT ZERO
AD5003 LDY BLOCKS
; Y REG COUNTS BLOCKS
==0342 LOOP
9D0000 STA $8000,X
; STORE FILLER AT STA
RT +X REG
E8 INX
; POINT X REG AT NEXT
LOCATION
D0FA BNE LOOP
; REPEAT 256 TIMES
EE4403 INC LOOP+2
; STEP HIGH ORDER BYT
E OF START ADDRESS
88 DEY
; DECREMENT Y REG (BL
OCKS)
  
```

```

D0F4 BNE LOOP
; DO ANOTHER 256 BECA
USE Y NOT= 0
00 BRK
; ON A PET THIS INSTR
UCTION WOULD BE AN R
TS(RET SUB)
; $0344 (836 DEC) IS
; HIGH BYTE OF START
ADDRESS
==034F FILLER
*==+1
; 847 DEC
==0350 BLOCKS
*==+1
; 848 DECIMAL
BLOCKS *==+1
; 848 DECIMAL
ERRORS= 0000

<M>=2000 AA AA AA AA
<M>=034F AA 02 AA AA
</> 034F 11 02
<M>=0344 80 E8 00 FA
</> 0344 20
<M>=033A
<B>/
034F 11 ORA (02),Y
<M>=2000 11 11 11 11
<M>=2100 11 11 11 11
<M>=21FE 11 11 54 41
  
```

Confusion dispelled

THERE SEEMS to be a certain amount of confusion concerning saving or loading data on the Superboard UK101, especially in Martin Collins' review in *Practical Computing*, May, writes S Graham of Edinburgh.

L Ritchie's approach in May, 6502 Special, is the best way, although placing a D in front of a number is not really necessary unless there is a danger of the user attempting to load a data tape in immediate mode, as if it were a program. Otherwise, the following can be used perfectly safely:

```

110 POKE 517,1 or 110 SAVE
120 PRINT A or print A$ for a string
130 POKE 517,0 "UNSAVE"
140 RETURN
and to load the value.
  
```

```

210 LOAD (or 210 POKE 515,1)
220 INPUT A (or INPUT A$ for a string)
230 POKE 515,0 ("UNLOAD")
240 RETURN
  
```

They will work for strings less than one line long. For longer ones, Kevin Ford's routines would be needed. □



Save with Fortronic



Volker Craig range of V.D.U.s.

Basic tele/type compatible	404	£599
Editor version of above	414	£749
D.E.C. V.T.52 emulation	4152	£788
A.P.L.	415	£799

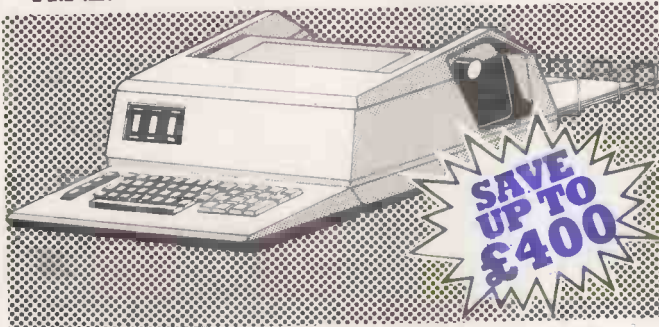

Tally 1612 K.S.R.

T1612 1200 Baud printer terminal with 42 Programmable functions. **Only £1,499**

FORTRONIC

for all your computer peripherals.

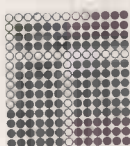

Fortronic Ltd, Holden Way,
Donibristle Industrial Estate,
Dunfermline.

Tel 0383 823121 Telex No 727438

Fortronic for all your computer peripherals.
Distributors for Tally, V.C., Facet/Qume and
Wang available ex stock.

• Circle No. 188

A SOUND INVESTMENT.

When you record on cheap cassettes you run a high risk of program failure, dropout errors and excessive headwear. Saving pennies on an unsuitable cassette could turn out to be very costly. To make a long life, high quality microprocessor cassette needs both tape and cassette mechanism to operate together in harmony. Backing up the microprocessor cassette technology is a background of more than 10 years of experience within the Group on the manufacture of computer tape, memory discs and cartridges. Pyral is one of Europe's foremost manufacturers of magnetic digital recording media.

The perfect match of cassette body and tape.



MP 12 and MP 15
Microprocessor
Cassettes

For further information on the
Microprocessor cassette and other
Pyral products send to:

Sales office: PYRAL MAGNETICS LTD, COURTLANDS ROAD, EASTBOURNE, SUSSEX. Tel: (0323) 638965 Telex: 871123

• Circle No. 189

NEW PRICES ON MEMORIES

2102L—450NS 1K x 1 SRAM	£ 0.55
2114-300NS 1K x 4 SRAM	£ 3.51
2114-200NS 1K x 4 SRAM	£ 3.86
4116-200NS 16K x 1 DRAM	£ 4.50
2708-450NS 1K x 8 EPROM	£ 4.39
2716-450NS 2K x 8 EPROM	£11.50
CARTER ASCII KEYBOARD	£39.50
AY—5-1013 UART	£ 2.60
2102L x 8 SRAM 450NS	£ 3.85
2114 x 8 SRAM 300NS	£24.45
2114 x 8 SRAM 200NS	£26.89
4116 x 8 DRAM 200NS	£31.35

Please add 50p Postage and 15% VAT to all orders.

Strutt Ltd.

Electronic Components Distributors

3C, Barley Market St.

Tavistock,

Devon, PL19 0JF.

Tel: Tavistock 0822 5439

Telex 45263

• Circle No. 190

M I C R O C O N T R O L

224, EDGWARE ROAD
LONDON W2 1DN
TEL (01) 402 8842



SALES SERVICE

Official Dealers — Apple II — Microstar — Compucorp

PRICE LISTS

APPLE II (16K) VIDEO OUTPUT	750.00
HIGH-SPEED SERIAL CARD	110.00
CLOCK CARD	140.00
LIGHT PEN	165.00
VOICE RECOGNITION CARD	127.00
LOWER CASE GENERATOR	40.00
EPROM BURNER & SOCKET ADAPTOR	99.00
PROTOTYPING BOARD	20.00
PAL CARD	72.00
B/W MODULATOR	20.00
PROGRAMMERS AID NO.1	29.00
APPLE II MODULATOR OUTPUT	770.00
DISK DRIVE WITH CONTROLLER	398.00
DISK DRIVE	355.00
DOS 3.2 MANUAL & DISKETTE	18.00
APPLE PASCAL	296.00
AUTO-START ROM	40.00
GAMES PADDLES	17.50
SUPER TALKER	190.00
APPLE II INTEGER BASIC MANUAL	3.55
APPLESOFT BASIC MANUAL	5.75
6502 PROGRAMMING MANUAL	8.90
APPLE II PLUS COLOUR (PAL)	819.00
6502 HARDWARE MANUAL	8.90
BLANK CASSETTE (C15)	0.85
MICROPRODUCTS PARALLEL PORT	40.00
8" FLOPPY DISK SYSTEM (1.2 MB)	2350.00
DISK BASED ASSEMBLER	30.00
VINYL CARRYING CASE	25.00
MICROCHESS 2.0 CHESS DISC	16.00
16K ADD-ON MEMORY	69.00
APPLESOFT FIRMWARE CARD	110.00
INTEGER FIRMWARE CARD	110.00
PARALLEL PRINTER CARD	110.00
COMMUNICATIONS CARD	132.00
APPLE II REFERENCE MANUAL	5.75
8ASF FLOPPY DISKETTE	3.50
CENTRONICS 775 PRINTER	869.00
CENTRONICS PRINTER CARD	132.00
HITACHI 9" B/W MONITOR	132.00
TRENDCOM 100 PRINTER	23.00
TRENDCOM PAPER (80 FT)	4.25
TC 3 TRENDCOM 100 I/F	49.00

NEW!

DIGITAL COLOUR CARD

Apple II or ITT 2020
Mixed Colour Text!!!

Complete software control allows
15 fully-saturated colours in
Graphics and Text modes.
Simple plug-in system. Existing
Software Compatible Designed
and Manufactured by us
Complete System. £148.00
Monitor Mod Kit £27.00

12-BIT RESOLUTION

A/D Conversion

Our new A/D cards offer high
12-bit resolution with a fast
conversion time, 4 inputs on board
expandable to 8.

Max. Sensitivity 10 uV F.S.D.
Demonstration Software
Supplied.

Turn your apple to a fast analogue
data aquisition system X, Y plotter
etc.

12-Bit System £174.
8-Bit System £116.

APPLE PASCAL TM

This Hardware/Software package
provides a very powerful tool for
the serious user. High speed hires
"Turtle" graphics, fast editor,
Compiler, Relocatable Assembler,
Excellent System Utilities, Superb
documentation £289.

**LEASING FACILITIES AND FINANCE
AVAILABLE
RING FOR QUOTE**

SPECIAL INTERFACES
We can design and produce special interface
systems at reasonable cost

COMING SHORTLY
COLOUR FOR PET TRS80

PART EXCHANGE
We offer generous P.X
allowances, ring for quote

All prices exclude VAT



PET 2001



from
£475

commodore
authorised dealers

TRS 80



from
£365

From Radio Shack Corp.

APPLE II

from
£695

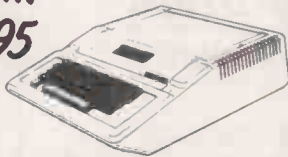

authorised dealers

SORCEROR

from **£740**



authorised dealers

ADVANCED SYSTEMS



122

MICROCOM

For Hardware, Software, Peripherals

BASIC SYSTEMS

PET 3016 (16K RAM and large keyboard)*	£675.00	PET 2001-8 (PET with 8K memory + integral cassette)	£475.00
PET 3032 (32K RAM and large keyboard)*	£795.00	PET 3008 (8K) with large keyboard	£475.00
		PET C2N External Cassette Deck	£53.00

ACCESSORIES

IEEE/RS232 Serial Interface 'A' Output only	£106.00	IEEE-448/Centronics type parallel Interface	£35.00
IEEE/RS232 Serial Interface 'B' Input/Output	£186.00	IEEE to Pet Cable	£19.00
Programmers Toolkit - 10 powerful new commands for your Pet - plug in ROM chip 8K and 16/32K resp	£75/£55	IEEE to IEEE cable	£24.00
		PETSET 1 16 Channel AD Converter c.w. all interfacing requirements	£166.00

BASIC SYSTEMS

TRS 80, 4K Level I consisting of Keyboard with 4K memory, Video Unit, Cassette Drive and 240v power supply unit	£365.00	TRS 80, 16K Level II (as above with 16K memory)	£499.00
TRS 80, 4K Level II (as above with Level II Basic)	£425.00	TRS 80, Expansion Interface with 16K RAM	£275.00
		TRS 80, Expansion Interface with 32K RAM	£360.00

ACCESSORIES

TVJ 232 serial interface	£35.00	Radio Shack Phone Modem	£160.00
Centronics Parallel Printer Interface (direct to keyboard)	£40.00	UHF Modulators (encased with leads for 625 lines)	£20.00
TRS 80, Voice Synthesizer	£345.00	RAM upgrade (4-16K, 16-32K, 32-48K) supplied and fitted at our premises (Kit £80.00)	£85.00
TRS Voxbox - speech recognition system	£135.00	S100 interface for TRS 80 (6 slots)	£375.00
TRS 80, Numeric Key Pad supplied and fitted	£49.00	TRS80 CPU 3 speed mod.	£26.00

BASIC SYSTEM

Apple II Plus computer - APPLESOFT extended basic in ROM - (16K RAM) - video output £695

ACCESSORIES

Apple black and white modulator for domestic TV	£14.00	Real time clock/calendar card - 1/1000 sec to 388 days with interrupt, software controllable	£128.00
Eurocolor card - provides colour on domestic TV	£79.00	Speechlab - provides voice control for the Apple	£127.00
Parallel Printer Interface Card	£104.00	Supertalker - adds human speech output!	£136.00
High Speed Serial (RS232C) Interface Card	£113.00	ALF Music Synthesizer Card	£180.00
Communications Card	£130.00	A1-02 Data Acquisition Card	£180.00
Centronics Card	£130.00	Graphics Tablet	£462.00
Integer Basic Firmware Card	£116.00	AC Line Controller	£270.00
PASCAL language system - includes language card to provide user with PASCAL, PALSOFT & INTEGER BASIC	£299.00	RAM Upgrade (16-32K, 32-48K)	£69.00
		Hobby Prototype Card	£20.00
		Romplus - u, l/c, mixed text/graphics	£105.00

BASIC SYSTEMS

Sorceror (inc UHF Modulator)		32K RAM	£790.00	48K RAM	£840.00
16K RAM	£740.00				

ACCESSORIES

Exidy Video Disk Unit (High Resolution monitor with Integral 630K Dual Drive)	£1790.00	Exidy S100 Unit	£240.00
		Exidy Video Monitor	£240.00
		CP/M on Disk	£145.00

ADVANCED SYSTEMS

TRS 80 Model II with integral 8" floppy disk drive and up to 64K RAM.
 Expandable up to 3 Megabytes Disk Storage (Available for demonstration - by appointment only). P.O.A.
 ACT 800 Systems providing 108K RAM, 46K User RAM, full size screen, high-res graphics. Ultra-fast data access and up to to 4.8 MBytes on-line disk storage P.O.A.

Special Offers!

PET BUSINESS SYSTEM

comprising
 CBM 3032 Micro
 computer, CBM 3040 Dual Disk Drive, CBM 3022
 Tractor Feed Printer and all cables
 £1999.00

News!

TVJ ARE ON THE MOVE!

Our Head Office is moving to larger and more prestigious showrooms (hopefully mid-May)

JOHNSON HOUSE
 75/79 PARK ST,
 CAMBERLEY, SURREY, GU15 3PN
 ☎ (0276) 20446

PUTERS ETC

Consultancy and Competitive Prices.

Registered business name



DISKS

PET	
CBM 3040 (dual drive) 343K User storage*	£795.00
Computhink (dual drive) 400K storage	£895.00
Computhink (dual drive) 800K storage	£1145.00
TRS80	
Shugart drive	£315.00
Micropolis drive	£315.00
Percom FD200 drive 110v	£299.00
Micropolis Dual Drive (394K storage)	£995.00
Corvus Hard Disk (11mB)	£3500.00
APPLE	
Apple Drive - 116K storage 1st drive	£349.00
Apple Drive - 116K storage 2nd drive	£299.00
Corvus Hard Disk (11mB)	£3500.00
SORCEROR	
Exidy - 143K storage	£495.00
Exidy Dual drive (630K storage)	£1195.00
Corvus Hard Disk (11mB)	£3500.00

PRINTERS

PET	
CBM 3022 (80 col with PET graphics - tractor feed)*	£525.00
TRS80	
TRS 80 Screen Printer (text - graphics) (110v)	£345.00
New Radio Shack Micro Printer	£245.00
GENERAL	
Teletype 43 KSR Serial (pin or pinch feed, 132 cols)	£825.00
RACAL Binder Printers - truly professional printers for microcomputers - high speed (up to 280 cps), upper/lower case	P.O.A.
OKI - parallel/serial (pin or pinch feed, 40, 80, 132 cols selectable)	£499.00
Centronics 779 parallel (tractor feed, 132 cols)	£825.00
DOLPHIN BDBOP tractor printer (125 cps bi-directional, 40, 80 columns - optional 132: u/l case & graphics). Available with Serial, parallel or IEEE interface	£525.00
Centronics Micro Printer (20, 40, 80 cols selectable)	£395.00
Heath WH 14 serial (80, 96, 132 cols selectable)	£475.00
QUME daisy wheel printers	P.O.A.
TCM100/MICROHUSH Thermal Printer (40 cols) inc. interface for PET/APPLE	£266.00
SILENT PRINTER for APPLE... allows printing of high res. graphics	£349

ETC.

Diskettes 5 1/4" (blank) boxed (min order 10) each	from £3
C12 Cassettes (min order 10) each	£0.35p
Ansaback 'phonemate' telephone answering machine, voice operated twin cassette	£190.00
Pace EZ-PHONE - Cordless Telephone	£225.00
Hitachi Video Monitors 9"/12" resp.	£127/£187
BOOKS - Large range of microcomputer related books and magazines	

TERMINALS

Pentland V1, 80 char./24 lines 2 page memory	£580.00
--	---------

PROGRAMMABLE CALCULATORS. TEXAS

INSTRUMENTS. Business Programmable Calculators - complete range. Send for list + prices. (We are authorised TI dealers).

IF YOU DON'T SEE IT - ASK IF WE HAVE IT

SOFTWARE

PET

PETSOFT authorised dealers - over 160 programmes on cassette and disk. Send for catalogue.

STAGE ONE COMPUTERS S/W dealers - PETAID, Stock Control, etc. Send for list.

74 Common BASIC Programs on one tape £15.00

PETAID Business Software - Sales and Purchase Ledger, Invoicing, etc. P.O.A.

CBM DISK-BASED BUSINESS SOFTWARE :-

COMWORDPRO II/COMWORDPRO IV powerful word processor, low/high level resp. £75/150.00

COMSTOCK - STOCK CONTROL - gives complete stock report £150.00

COMBIS - BUSINESS INFORMATION SYSTEM - Storage & Retrieval of all types of company records £150.00

COM ACCOUNTS - Full Financial Business Accounting System incl: Sales, Purchase, Nominal Ledgers £650.00

COMPAY - Handles hourly, weekly or monthly paid employees £150.00

COMPLANNER - Personal information tool for the busy executive £50.00

(We are authorised CBM Business Software Dealers) Send for List.

GD 1001 - Assembler Development System £50.00

GD 010 - Lisp Interpretive Language (Artificial intelligence) £75.00

CAR INSURANCE QUOTATIONS - computerised car insurance quotation suitable for insurance brokers (TVJ S/W) £25.00

MORTGAGE QUOTATIONS - suitable for agents/mortgage brokers (TVJ S/W) £25.00

TRS 80

COMAC III SUITE - computerised accounting for TRS 80 (TVJ SOFTWARE) £75.00

STOCK CONTROL - complete inventory control - recorder level - P/O's etc. £115.00

CP/M £95.00

CBASIC £75.00

FORTRAN includes compiler, relocatable assembler text editor and linking loader £95.00

PASCAL - tomorrow's programming language today £195.00

ELECTRIC PENCIL - powerful word processor allows full cursor movement, insert/delete, string search block movement, adjustable line length, justification on cassette £45.00

ELECTRIC PENCIL as above - disk version £95.00

LOWER CASE MOD KIT ONLY/FITTED for Electric Pencil £8.00/£28.00

DATA MANAGEMENT/REPORT GENERATOR - easily formats disk files, allows entry, edit, delete and list of records and retrieves data for display or calculation on screen or printer £150.00

RSM-2D DISK MONITOR - powerful system manipulates disk data, has Z-80 break routine £25.00

ST80D communications software £60.00

NEWDOS - TRSDOS with corrections and enhancements £25.00

NEWDOS+ - as above but with further facilities:-

KBFIX, Renum, Screen to printer in one step, DOS commands from BASIC, Level I in II, Superzap, Disassemble, load and save faster, list variables £49.00

LIBRARY 100 - an assortment of 100 programs £39.00

SARGON CHESS - 16K Level II - the 1979 Champ Version I £14.00

APPLE

Microchess 2.0 Chess Disk £15.00

U-DRAW II - High Resolution graphics editor. Create a figure then rotate, expand, contract etc and store on disk £27.00

LISP - programming language suitable for research in artificial intelligence £30.00

3-MILE ISLAND - Complex disk based game simulating nuclear reactor £27.50

VISICALC - Instant Visual Calculation - provides a powerful planning and forecasting tool £95.00

APPLE WORD PROCESSOR - Complete text editing, storage and retrieval of text (disk based) £42.00

LITTLE GENIUS - Comprehensive disk based Apple Soft Tutorial £35.00

ACT Appeware and MUSE authorised software dealers - Many programs on cassette and disk. Send for list.

SORCEROR many programs available - send for list.

Word Processor Rompac £120

Development Pac £70.00

* 5% DISCOUNT ALLOWED FOR EDUCATIONAL ESTABLISHMENTS



T&V JOHNSON (MICROCOMPUTERS ETC) LTD

Member of the TV Johnson Group of Companies

Camberley (Head Office)
165 London Road, Camberley
Surrey, GU15 3JS.

☎ (0276) 62506
☎ (0276) 20446

PRICES EXCLUDE VAT, FREIGHT & HANDLING SEND OR PHONE FOR PRICE LIST & BROCHURES (All prices correct at time of compilation)

Oxford
148 Cowley Road, Oxford
OX4 1JJ.

☎ (0865) 721461

Bristol
48 Gloucester Road, Bristol
BS7 8BH

☎ (0272) 422061

Directors: Dr. R.V. King BA, MIEE
S.G. Johnson, BSc. (Hons.)
T.S. Johnson, ABIBA, ACMB, FBSC, MBIM
A.S. Barton ACII, ABIBA, CdiPAF.

Branches at:
Birmingham, Bristol, Edinburgh, Leeds, London, Louth,
Newmarket, Nottingham, Oxford, Byfleet, Wokingham.

Hours of business
Mon-Fri. 9.30 - 5.30
Sat. 9.30 - 1.00

+ Ansaback eves
and w/ends.
Telex 858893

123

DISKWISE LTD

THE Apple agents for
Devon & Cornwall
COMPLETE BUSINESS SYSTEMS
FROM £2,250

EXCLUSIVE
HOTEL MANAGEMENT (inc.
booking & guest billing) SYSTEM
& TV RENTAL MANAGEMENT.

DEALER ENQUIRIES
WELCOME

DISKWISE LTD, TREKENNER,
LAUNCESTON. Tel: 05797 628

• Circle No. 193

WHAT "Turns a board
into a real computer"?

MICROCASE!

We make cases for micros.
Stylishly designed.
Beautifully made.

Room for extensions + PSU.

**SUPERBOARD
COMPUKIT**

NASCOM 1 & 2

OR UNCUT FOR OEM USE

From your dealer or write to:

MICROCASE

Simple Software Ltd

15 Havelock Road

Brighton BN1 6GL

+ SOFTWARE for SUPERBOARD +

• Circle No. 194



... Look! ...

Stop mains interference!
with the **BLL Voltage Suppressor**
Handles 1800 watts at 6 amps
Helps stop interference
between 180 KHz + 100 MHz
£19.00 inc. VAT P&P

We have
8" and 5 1/4" floppy disks,
Hewlett Packard, listing
paper, BLL mains interference
suppressors, Altos, CBM, PETS,
printers, drives and much more
in stock.

31 Palmer St., by Caxton Hall,
London S.W.1. (just be St.
James's Park tube)
01-222 1122 Mon-Fri. 9.30-5.30
or call (09327) 86262 for an
appointment at Planer Bldg.
Windmill Rd., Sunbury, Middx.

• Circle No. 195

Apple COS: the use of the zero page, language changes and error-proofing

In the third part of his series on the creation of a cassette-operating system for the Apple II, Hugh Dobbs examines zero-page usage, possible language changes and a solution to a common problem.

ALL microprocessors are different. The 6502 found in Apple, Pet, AIM, Kim and Superboard is unusual in its organisation of memory. Firstly, it has no input/output instructions as such, so that all I/O has to be memory-mapped.

There are addresses reserved for cassette I/O, speaker, game controls and keyboard, and these, together with the regions of memory assigned to the extension connectors and switches, make

vectors, top/bottom/left/width of scrolling window.

Thirdly, the 6502 stack is circular — it occupies 100 to 1FF H, and is managed by an eight-bit stack pointer so that 100 is effectively adjacent to 1FF for PHA, PHP, PLA, PLP, JSR, and RTS/RTI instructions. Page-one locations can also be addressed by absolute instructions.

In addition to those restrictions on memory use which are determined by the processor itself, Apple reserves the whole of page 2, 200 to 2FF H, as the keyboard input buffer. FP also uses page 2 for input processing. COS also uses page 2 for command decoding—applied only during printout under program control, when the input buffer is not in use.

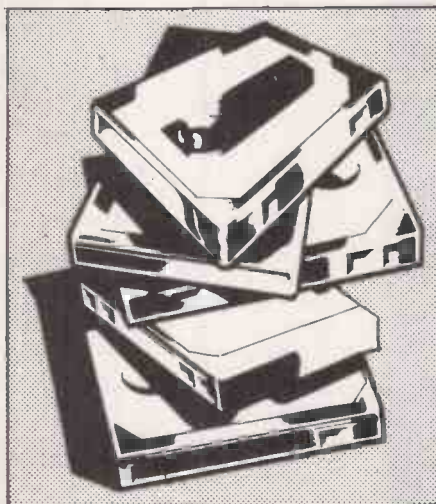

Video display

Pages 4 to 7 inclusive, apart from 64 marginal bytes, are used for video display and are subject to scrolling. If the window-width is increased beyond forty-eight, scrolling and, more importantly, the subsequent blanking of the bottom line of the scrolling window extend into page 8, wrecking the cassette version of Applesoft, or INT variable storage, or FP program storage, or the COS HELP page.

COS I/O pointers will not be affected unless the window-width is more than 168, which is more than any of the common printer pages.

Basic programs

The remaining RAM memory, from page 8 onwards, is used for Basic programs, variable storage and certain other purposes. It amounts to 30Kbytes on a 32K machine. You will note that page 3 has not been mentioned. Only a few areas of page 3 are used: the non-maskable interrupt vector points to 3FB H, the interrupt ReQuest vector points to (3FE), the contents of 3FE and 3FF, but NMI and IRQ are not used in the basic Apple.

In monitor, CTRL-Y cases a JSR to 3F8 H; the FP & command calls a machine-code subroutine at 3F5 H; and the DOS

a 4Kbyte hole in the Apple memory, (C000 to CFFF H).

That is why the larger Apple has 48K RAM and 12K ROM rather than the full 64K. It is, of course, possible to ghost most of the I/O. Presumably something like that is done with the Pascal system which has an extra RAM board.

Secondly, the first 256 bytes of RAM, the zero page, can be regarded as either 256 eight-bit registers or 128 16-bit registers which can be addressed by the special 6502 zero-page instructions — two bytes each — as well as by the normal absolute instructions — three bytes each.

For that reason, most page-zero locations are used by one or another of the languages or by the monitor, for instance, pointers for INTeger Basic and for Applesoft (FP), FP re-start vector, FP instruction-reading routine, monitor I/O

re-start vector is stored at location 3D0.

Because of the extent to which the zero page is used, I have not made any use of it at all for COS pointers, although it would have resulted in a shorter, ROMable program. What we have to do now, however, is to look at the page-zero locations used by INT and by FP to find which ones will have to have their contents altered to protect COS from being overwritten.

The FP handbook gives the locations of all the appropriate pointers. The ones

which affect us are those which are set to 00 08 or 01 08 or 03 08 when FP is cold-started, CTRL-B following C080, LOMEM, start-of-free-space, end-of-program, start-of-free-space, and so on. Unfortunately, they apply only to FP, and the INT handbook does not give such detailed information.

Like the rest of RAM memory, the zero page is filled with rubbish, usually 00 00 FF FF 00 00, when Apple is switched-on. To see the effect of cold-starting INT or

(continued on next page)

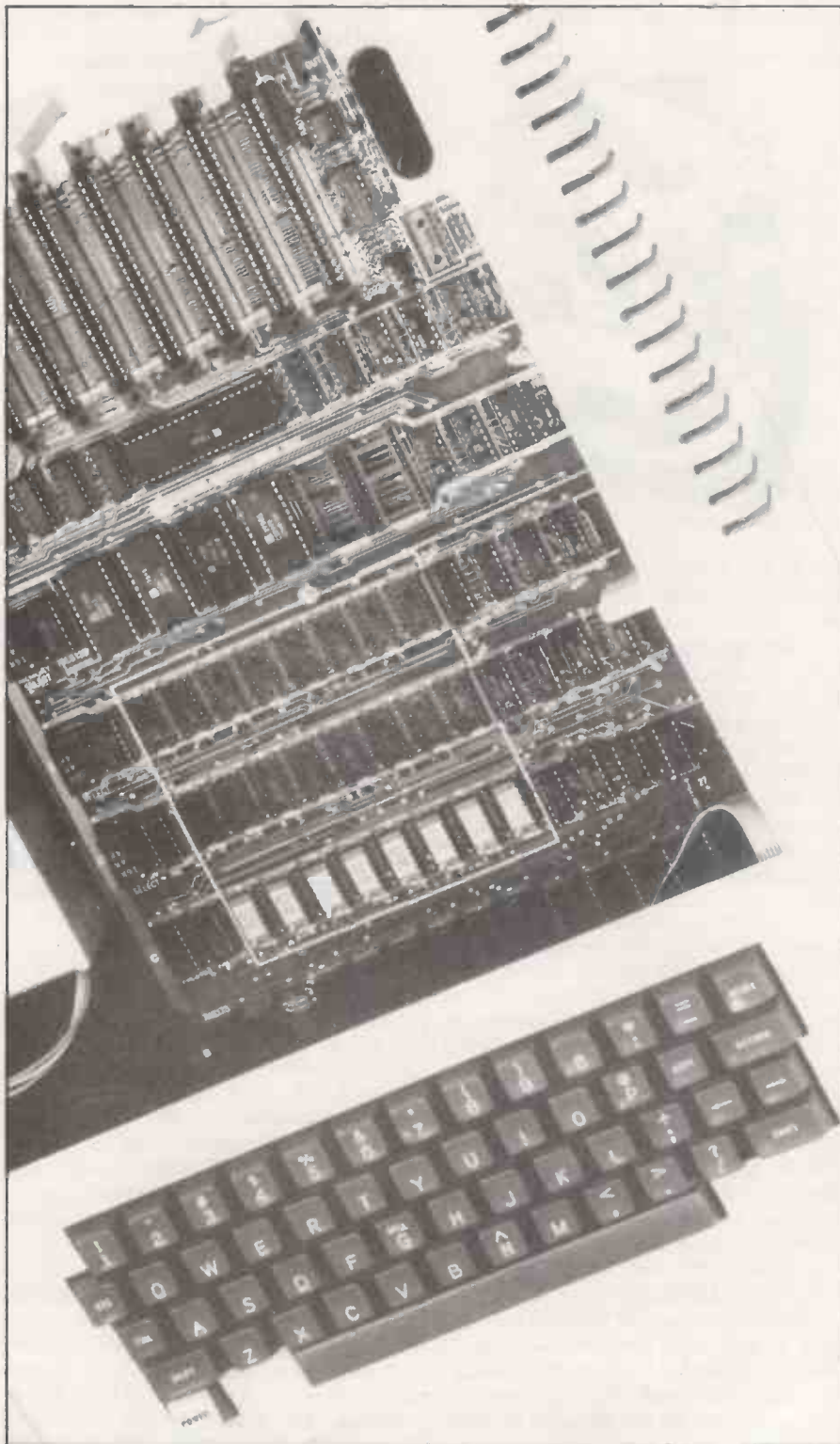

NASCOM 1 & 2

AT LAST!
A CHANCE TO PROFIT FROM YOUR HOBBY!

We will pay handsome royalties to sell your BASIC & M/C CODE programs-graphics if possible — games, educational, programming aids etc.

SEND S.A.E. NOW for details or Tel. (0532) 683186

BASIC programs available include: —

Super Startrek (min 16K)	£9.95	Send Chq/Po's
Sheepdog Trial (NS)	£5.95	+ 45p/order p.l.p.
3D Noughts & Crosses (NS)	£5.95	or See for latest
Submarine Chase (G)	£5.45	catalogue to: —
Labyrinth (NS/G)	£5.45	PROGRAM POWER
Stalom (NS/G) £5.95. Othello	£5.45	5 Wensley Road,
(G = Graphics, NS = Nas-sys only)		Leeds LS7 2LX

• Circle No. 196

TOPMARK Computers

dedicated to
APPLE II

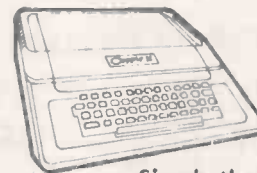

Simply the best!

Full details from Tom Piercy on
Huntingdon (0480) 212563 or circle
enquiry card.

• Circle No. 197

ORCHARD ELECTRONICS

ORCHARD HOUSE
21 ST. MARTINS STREET
WALLINGFORD
OXON OX10 *DE

Specialists in the supply of:

- PETS and Peripherals
- Computhink
- Anadex
- TCM
- Software
- Discs
- Paper and Tapps

For these and sympathetic after-sales
assistance contact Barry or Dave on:

0491 35529

• Circle No. 198

WE PROGRAM MICROS

Occasionally for Ohios

Periodically for Pets

Also for Apples

S Software Services

14 Herbert Street, Dublin 2, Ireland.

Tel: 765197

• Circle No. 199

SHOP WINDOW

Superboard-, UK101- and TRS-80-compatible

COLOUR YOUR NASCOM!



DAZZLING COLOUR GRAPHICS FOR NASCOM 1 & 2

Genuine bit-addressable "pixel" system for straightforward programming of pictorial or mathematical functions.

8 Colour display plus 8 colour independent background facility. Full documentation with FREE SOFTWARE: powerful sub-routines for vector generation, demonstration program for animated effects. All runs in Nascom 1 without expansion. Complete with UHF Colour Modulator for operation with normal colour TV set. Superior design allows connection to most other micro-processor systems — send us diagrams etc of your b & w video circuitry for free advice. Don't be fooled by the price: this is a top quality product which will transform your computer.

NOW AVAILABLE FOR **£45 + VAT**
LIMITED PERIOD AT

**WILLIAM
STUART
SYSTEMS LTD**

Dower House, Billericay Road,
Herongate, Brentwood,
Essex CM13 3SD
Telephone Brentwood (0277) 810244

• Circle No. 200

TRS-80 System

All items stocked, Barclaycard, Access & American Express are welcome, or apply for your own RADIO SHACK Charge Card. U.K. Delivery by Securicor. Direct and Personal Exports.

RADIO SHACK LTD.
188 Broadhurst Gardens,
London NW6 3AY.

Tel: 01-624 7174 Telex 23718

• Circle No. 201

EXIDY SORCERER

48K £849 + VAT
32K NOW ONLY £799 + VAT

Dealer for

Bristol and South West

ELECTROPRINT (Mr. Tasker)

5 Kingsdown Parade • Bristol 6 • 2923/5

• Circle No. 202

PET SOFTWARE

Full range of games and business programs available at large discounts. E.G. Microcheess — £11.20
Mailing List — £12.00
Disc Based Stock Control — 40.00
Also new in, the amazing Compuphone a computer controlled telephone with automatic dialing and 100 number memory.

Contact
Abtech Ltd.

Orgreave Crescent
Sheffield, S13 9NQ.

Tel: 699371-4 Telex: 547700.

• Circle No. 203

(continued from previous page)

FP, it is useful to set the whole page to FE H or some such unlikely value first. It is not possible using the monitor alone; whereas typing

```
*300:FE
*301 < 300.3FEM
```

will set the whole of page 3 to FE, the corresponding sequence for the zero page,

```
*0:FE
*1 < 00.FEM
```

does not work; the second instruction crashes the system, and you have to re-set.

```
*0.7F
```

will now display the contents of the first

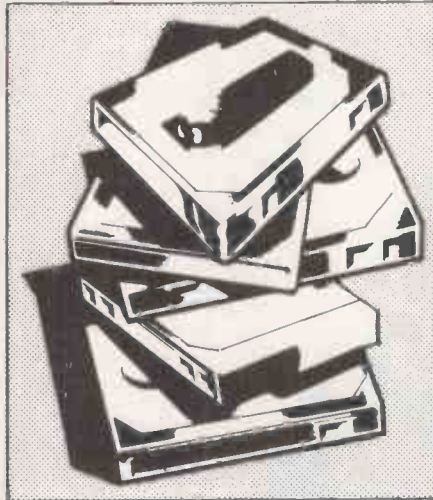

half of the zero page, showing that FEs have been stored at least as far as location 1FH.

In fact, the process is as far as location 3CH, which holds the low-byte address of the next byte to be moved. Its contents were changed from 3B to FE, which was matched against the low-byte address of the final byte to be moved, in location 3E, and found to be equal. The high-byte addresses were also matched and found to be equal, locations 3D and 3F both contain 00, and so the move then terminated.

By that stage, it had overwritten the storage for the scrolling-window limits, for the cursor horizontal and vertical positions, but most importantly, for the input and output vectors — locations 36 to 39 H. When the monitor tried to issue its next message — either a bell or a retn — control was transferred to FEFE H instead of to the usual output routine at FDF0 H.

What happened after that is not too clear — FEFE is in the read subroutine but is not a valid entry point — but it is possible to obtain some idea by examining page 1, the 6502 stack area, to see the stored return addresses.

Note the advantage of the 6502 arrangement of restricting the stack to page 1. Even an infinite loop with more JSRs and PHs than RTSs and PLs can devastate only page 1 and the rest of RAM memory is protected.

What we want is a machine-code routine to write FEs into page zero and to jump to the re-set entry point to restore those locations which are necessary for system operation: start the ASSEMBLER (*F666G) and type

```
1300:LDA #FE let's work in page 3 for a change.
```

```
! STA 0
! INC 303 change 0 to 1 ... to FF and back to 0.
```

```
! BNE 302 if 0, we have finished.
! JMP FF59 'RESET' entry to monitor.
```

```
!(re-set)
```

```
*300G test it.
```

Now you have as much of page zero as possible set to FEs, store a copy of it by moving it somewhere else in memory:

```
*1000 < 0.FFM Move to page 10 H
```

```
*1000 < 0.FFV Verify the copy.
```

Random number

Note that two bytes have changed. 4E H and 4F H store a 16-bit random number — an ordinary number which is incremented as part of the keyboard scan subroutine, so that it changes by an unpredictable amount every time Apple expects a key input. It is most unlikely that either byte is the same as it was when the copy was made, so both are reported on verification.

As explained at the start of the series, I am assuming throughout that you have a 32K Apple II with INTEGER BASIC on the main board and Applesoft II (FP) in ROM, and no disc system; and that the hardware switch on the back of the FP ROM board is set to select on-board ROM, INT, etc., on re-set. So CTRL-B, retn at this stage will put you in INT.

During the code-start, INT sets a pointer for LOW MEMORY: to 800 H and copies it into another location which is the pointer to the storage area for variables. In INT, all variables are stored together irrespective of type — strings, integer variables, integer arrays.

INT does a non-destructive test of the first location in each page of RAM thereafter — read, complement, store, check, complement, store, check — until that no longer works.

Input area

Either you have a dead memory location, or there is nothing at that address, 4000 H on a 16K Apple, or 8000 H on a 32K, or it has reached the keyboard input area — C000 H will be the limit on a 48K Apple. That address is stored as the HIGH MEMORY: pointer, and copied into another location which points to the start of any INT program when you write one. Now re-set and

```
*1000 < 0.FFV
```

compare the changed page-zero contents to the previous copy.

As before, 4E and 4F will almost certainly have changed, but so should about 19 other locations. The ones which concern us at present are 4A to 4D and CA to CD. At this stage, *4A.4D should

give "00 08 00 80" if you have a 32K machine. The last byte will be 40 or C0 for 16K or 48K. 4A and 4B are copied to CC and CD; 4C and 4D are copied to CA and CB, so *CA.CD should give "00 80 00 08", etc.

Most of the other changes are bytes which have been set to 00, but there are two further points of interest: locations D9 and F8 which now contain 7F. Repeating the sequence CTRL-B, retn, re-set, *1000 < 0.FFV will change them both to 3F, and CTRL-C, retn, re-set, *1000 < 0.FFV will show that only location D9 has changed to 1F.

Clearly, there is an LSR D9 in the warm-start procedure and an LSR F8 in the cold-start procedure for INT which is a subroutine preceding the warm-start, unlike FP where the situation is obscure. F8 is a flag whose high bit is set to show either that AUTO line-numbering is in force, or that INT has not been properly initialised, or that you have been using FP since the initialisation. Any of these states is, of course, cancelled by cold-start.

Pointer verified

To determine which of the various pointers 4A to 4D and CA to CD has which function, re-enter INT — warm-start: CTRL-B — then

> A = 5 do not forget the retn, re-set.
 *4A.4D will display one set of pointers, and the other.
 *CA.CD

Whichever has changed is the end-of-variable-space pointer. Return to INT and > RUN (***) NO ENDERR, re-set.

Then verify that this pointer has returned to its original value — RUN clears all variables. Return to INT and > 10 REM and re-set.

This time, the start-of-program pointer will have changed, since INT programs go to the top of memory. It turns out to be CA-CB (low-high) and that is a very useful fact for those times when you lose a program either by CTRL-B following a re-set, or by using NEW when working in INT.

Search through memory using the monitor until you find the start of your program — it usually starts "XX 0A 00" if you usually start your program with line 10 — and then if the XX is at the HLLL Hexadecimal,

*CA: LL HH

where, of course, you entered the appropriate values for HH and LL and which will re-connect the program. Then warm-start INT, and LIST to check.

DOS lives above HIMEM: and hence changes the HIMEM: and start-of-program pointers. That is probably more practical than what I have chosen to do and means that it can coexist with the RAM version of FP which occupies 800 to 2FFF H.

For the moment, though I keep discovering new disadvantages, COS will continue to live below LOMEM: and will

have to change the LOMEM: and end-of-variable-space pointers.

The change we need to make will depend on the length of COS itself and on the amount of space we want to reserve for files. That space might be quite large if we allow for the difference in access times between tape and disc storage — larger blocks will probably be more efficient.

For the moment, we can suppose that COS ends at FFF H, though this will be revised upwards. Assuming that for the moment we do not need any file space apart from the input buffer, we can allow either Basic to use anything from 1000 H upwards.

Minor changes

That can be done for INT simply by cold-starting it and changing the 08 in locations 4B and CD to read 10. FP has far more pointers, but fortunately they are all listed in the FP handbook, Appendix L.

Unfortunately, the FP cold-start routine not merely sets six pointers to 800, 801 or 803, but also sets the contents of locations 800 to 802 to be 00. The contents of location 800 do not seem to matter except that anything other than 00 produces a ? SYNTAX ERROR message following a NEW command but does not prevent the program from being deleted which would have been useful.

Any FP program you may write begins at 801 with the two-byte absolute address of the second line of your program, and a double 00 in these locations — the end-of-program marker — shows that there is no program yet. That means we will also have to write 00s into locations 1000, 1001, and 1002 before FP will run properly with the new pointers.

Unaffected locations

Now, in fact, 4B and CD are not affected during FP cold-start, and 68, 6A, 6C, 6E, 7E and B0 — the FP high-address pointers which need to be changed — are not affected during INT cold-start. We can cold-start the desired Basic and set all those locations to 10 and set 1000 etc., to 00, without causing any difficulties for either system. We can alternatively replace every 08 in page zero with a 10, again without causing any problem.

Now let us put it together. Start the assembler and:

```
!ELA:NOP
! LDA # 81; *INT C081: latch to
gap to allow select on-board ROM.
INT to start at odd address.
! BNE E21; TOSETBAS forced.
! LDA # 80; *FP C080: latch to
select FP ROM.
! CMP A79; SETBAS has this
Basic been cold-started
already?
```

(continued on next page)



RE-USEABLE * * * * * NEW

VIDEO PLANNER DISPLAY

Useful Programming Aid
 Speeds Graphics Planning
 Re-useable 100's of times
 Clear side for notes

* * * * *
 only available for,
 £2.70 each PET, TRS80
 (inc. P.P) (please specify choice)
 IMPEX ENTERPRISES, 12 Wallscourt
 Rd, Filton, Bristol, BS12 7NS.

• Circle No. 204

Tame PET? Sour APPLE? Call us NOW, we'll offer you a fair price. We also buy new or redundant software.

Why? Because we specialise in supplying new and secondhand systems to both business and personal users.

SIGNDATA LTD
01-837 8927

• Circle No. 205

S&J NATIONWIDE COMPUTER SALES

NOW AVAILABLE

SHARP MIZ-BOK

FROM £480.00 + VAT

FREE WITH EVERY ORDER: —

Choose 3 of the following
 Breakout, Supersimon, Mastermind,
 Shape Match, Graphics/Music, Lunar
 Lander, Bomber, Snakes & Ladders,
 Fireballs, or Donkey Derby.

COMING SOON!
HAND HELD MICRO!

For further details & Price List send S.A.E.

Make P.O.'s/Cheques payable to: —
S&J NATIONWIDE COMPUTER SALES, BOX 25, PRACTICAL COMPUTING

• Circle No. 206

APPLES + PETS

Hardware & Software expertise in KENT.

Call today to discuss your requirements.

The Computer Room
 21 Monson Road,
 TUNBRIDGE WELLS, KENT.
 Tel: (0892) 41645

• Circle No. 207

apple II in sussex

complete user service

Apple & Microstar, hardware & software
systems for Micropad handprint data entry

oval computer systems

elm park, ferring.
worthing, west sussex.
tel: 0903-44831

• Circle No. 208

ANDREWS COMPUTING LTD

Programs for minimum Nascom-1

— Fruit Machine Game	£3.45
— Submarine Chase Game	£3.45
— Game of Life	£3.45
— Minefield Game	£3.45

Programs for extended Nascom-1

— Renumber Basic Program	£4.60
--------------------------	-------

All supplied fully documented with listings on B-Bug, T4 or Nasbug format cassette tape.

C20 cassettes (inc. library cases)	5	£2.76
	10	£4.83

Machine code, Assembler or Basic coding forms. £1.60 each pad (approx. 80 sheets). Add 35p for p&rp, all prices include VAT. Send SAE for details:

21 Lime Tree Drive, Farndon, Chester

• Circle No. 209

Some people would give anything to have your micro experience

Especially if you have practical experience with PASCAL on the APPLE micro computer. Richard Kaluzynski will put you in touch with them.

Knight Computer Services Limited,
14 Old Park Lane, London W1Y 4NL.
Tel: 01-491 4706.



Staff Services Division of BOC Datasolve Group and a member of Computing Services Association

• Circle No. 210

(continued from previous page)

```
! BEQ E35; TOGOBAS if so, skip this
! STA A79; ROMSEL part: do not
! ORA 878; INFLAG re-initialise.
! STA 878; INFLAG set RAM
! LDA #0; COLD switch for
! STA A7C; CS/WS INT or FP.
! NOP do not kill
! JMP A78; *GOBAS EXEC mode,
! NOP let GOBAS if set.
! LDA C081; *ASM set high bit of
! JMP F595; GOASM ASM is in on-
! CLD; **BYE board ROM
! JMP FF69; GOMONZ with INT.
! start monitor without killing COS.
```

The first free, odd, address is now E43.
* in the listing indicates a COS command routine and by inserting two NOPs, we



have acquired an extra command. Return to whatever Basic we were in last, without losing the program.

That covers the first stage, at least, of all the language changes we may want for the moment. INT, FP, ASM, BYE — traditional exit from Basic — and a re-start-Basic.

That is about the ninth version of the language-change section, which has been rather tricky. We have some code to enter before it is fully operational, but even at this stage you can test ASM and BYE:

```
!SE3FG should switch to monitor.
!*E39G should switch back to ASM.
Re-set and enter FP.
```

] CALL 3641 should switch to ASM directly from FP.

That is quite an achievement since the two languages occupy the same address space. Now we need the non-ROMable Basic entry routine, which is to start at A78:

```
!A78:LDA C000; ROMSEL will be C080
or C081
before it is
used;
C000 here
shows that
neither Basic
has been cold-
started yet.
! JMP E000; CS/WS set for cold-
start; E003
for warm-
start.
```

You can now test the INT and FP routines:

```
!SE1BG (into INT); > CALL 3647 (into
monitor); *E1FG (into FP); ] CALL 3611
(into INT and so on).
```

The routines are still not complete. CALLING 3611 has the same effect as NEW if you are in INT, while it should have no effect at all. Similarly for CALL 3615 in FP. That is because although we have provided a routine to select cold-start, there is no way as yet of switching it over to warm-start.

Secondly, we have done nothing, as yet, to change the low-memory Basic pointers, so that COS will be overwritten by FP programs and variables, or by INT variables. Thirdly, we have set one bit, perhaps two, in a location called INFLAG.

During or after the initialisation, cold-start, Basic issues a retm — two in the case of FP — a prompt and sets a cursor flashing and waits for input. If COS is connected, control will then pass to the COS input bug at C1B which as yet is only a stub.

INFLAG controls the branching in that part of the program, and I am hereby re-defining the meaning of the various bits in it:

878: INput FLAG : bit 7 is Basic cold-start; bit 6 is EXEC; bit 5 is READ, and bit 0 indicates INT rather than FP for cold-start handling.

We now have to re-write the input bug:

```
!C1B:PHA; INBUG 14 April 1980.
! LDA #20; mask bit 5.
! BIT 878; INFLAG
! BMI C2B; TOXBASIC branch on bit
7, top
precedence.
! BNE C27; TOREAD branch on bit
5, higher
precedence
than EXEC.
! BVS C27; TOEXEC branch on bit
6.
! PLA normal exit.
! JMP(8FE); TOKEYIN to keyboard
input routine.
! PLA; XBASIC handle cold-
start.
! STA (28), Y kill cursor.
! LDA 878; INFLAG
! AND #7F re-set bit 7.
! LSR bit 0 into
carry bit (1 =
INT, 0 = FP)
```



```

! PHP          save processor
! ASL          status, in-
!              cluding carry.
!              shift back,
!              with 0 going
!              into bit 0.
! STA 878;     INFLAG overall, we
!              have cleared
!              bit 7 and bit
!              0; the value of
!              bit 0 is saved
!              as the carry
!              flag and
!              pushed on the
!              stack, from
!              which we now
!              recover it.
! PLP          E003: warm-
! LDA # 3;     WARM start entry
!              to Basic.
! STA A7C;     CS/WS set RAM
!              switch to
!              warm-start
!              hereafter.
! LDY 97E;     COSEND pick up
!              pointer to
!              first free
!              page after
!              COS; it is
!              stored in
!              RAM to allow
!              it to be
!              changed if we
!              want to leave
!              space for
!              files.
! BCC C4C;     TOXFP if carry is
!              clear, this is
!              FP.
! CLC;         XINT if not, it is
!              INT.
! STY 4B       set INT low-
!              memory
!              pointers.
! STY CD       restore Y, A,
! JMP FD0C;    RDKEY cursor and go
!              to normal
!              input.
! DEC 25;CV;   XFP move up to
!              overwrite FP
!              prompt.
! JMP F1A7     F1A7 is the
!              point in FP
!              initialisation.
    
```

```

*4A.4D        display first INT pointer area
              (00 08 00 80 maybe).
*CA.CD        display second INT pointer area
              (00 80 00 08 ?).
*E1BG        Go into INT.
              CALL 3647 (or -151) into monitor.
*4A.4D        display first INT pointer area
              (00 10 00 80 ?).
*CA.CD        display second INT pointer area
              (00 80 00 10 ?).
    
```

The 10 in 4B and in CD shows that we have succeeded in changing the low-memory pointers. Further investigation should show that INT operates normally in all respects, except that variable storage starts at 1000 H instead of 800 H. For instance, if you set A = 3 in INT and then switch to monitor,

```

*CC.CD        will give 06 10, end of variable
              space, and
              will show C1 00 06
*1000.1006    Similarly, we can check the effect on FP:
    
```

```

*67.70        displays most of the FP
              pointers; of these, 68, 6A, 6C,
              and 6E are 08 if FP has been
              initialised normally.
*E1FG        into FP.
              CALL 3647 into monitor.
*67.70        should show all the 08s
              changed to 10s; you can also
              check 7E and B0, 10 again; and
              should show 00 00 00, FP
              start and end of program
              markers. That has not pre-
              vented 800 to 802 from being
              set to 00.
*1000.1002
    
```

The language-changing section can operate on its own, but if the output bug is connected, the low memory pointers remain at 08 after initialisation instead of being changed to 10.

That is because a return to command mode causes the COS output bug to kill all input modes except EXEC; the relevant section is at D1A to D21, where we had

```

! LDA #40
! AND 878;     INFLAG
! STA 878;     INFLAG
    
```

and clears everything but EXEC. All we have to do is *D1B:C1 so that it does not re-set bit 7 or bit 0.

If you have the rest of COS, you could try adding new words to the command table. It would then end with

```

***(08)BYE(1F)ASM(1C)(83)(1A)FP(0F)INT
(0D)HELP(00)
    
```

or, in Hex values,

```

... AA AA AA 08 C2 D9 C5 1F C1 D3 CD 1C
83 1A C6 D0 0F C9 CF D4 0D C8 C5 CC
D0 00.
    
```

The new commands will not work satisfactorily, however, until you find a solution to last month's problem.

The reason for the trouble was that the command decoder omitted to change the operating MODE flag when it read a command, and when a further return was received, it repeatedly decoded the same command.

The cure for that is to insert a STA 879 at some point in the decoder. I do not want to do that, as we will still need to know whether it was a keyboard command or CTRL-D printout, for some commands. Make the change yourself if you like, but save the existing COS first. [E]

Re-initialisation

Where HIMEM: and associated pointers have been set and Y contains 08 and X contains 00, forming 0800, ready to set all the low-memory pointers. Our routine leaves X with 00 — input buffer pointer set to zero by normal input routine — and Y with COSEND, so that it re-initialises FP with the desired values. It remains to set COSEND, so re-set and *97E:10 temporarily. Also, if you do not have the earlier parts of COS, you will need to set the exist vector for the input bug: *8FE:1B FD to point to the normal keyboard input routine.

Now connect the COS input bug only — do not use C00G if you have the full system so far: *39:C direct monitor input routine to jump to C1B instead of the usual FD1B. That should be transparent, that is, it should have no obvious effect. We should also change A79 to show that neither Basic should be warm-started at first:

```

*A79:0        or any number other than 80
              or 81
    
```

PETER SCOTT

FOR
APPLE, SHARP MZ 80 K
TEXAS
SALES & SERVICE

Computer books, stationery, floppy discs, tapes etc.,
Ring or call and discuss your requirements

PETER SCOTT (EXETER) LTD.,
76-78 SOUTH STREET
EXETER
EXETER 73309/56633

• Circle No. 211

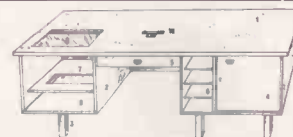

'MICRO-STATION'

Craftsman-made to office standards. Teak finish with unique features — all cables out of sight. Feed-through paper, sliding printer & drive shelves etc. 6' x 3' x 28"1 to house ALL your peripherals in style.

£196 ex works, VAT+
VEMBAROY LTD.
The Bringley, Church Street,
Gt. Baddow, Essex
0245-71726

• Circle No. 212

Functional Business Software on Cassette for TRS 80 LEVEL II 16K

British Software written for British companies and now is in daily business use:

- 1) "BANK A/C" PROGRAMME!
21 column analysis, self totalling on all columns keeps full alpha and numeric records at command show's monthly and yearly totals to date, partners drawings, total o'heads to date, etc. £35.
- 2) "DAILY SALES" PROGRAMME!
Full record for a month, 17 entries for each invoice, plus totals 8 columns, searches and totals individual accounts, weeks sales, months individual heading totals, displays entire files £35.
- 3) "ORDERS FILE" PROGRAMME!
Searches by name, order no., customer order no., agent. Running totals of orders still in hand, totals agent sales, etc., displays entire file £35.
- 4) "IMPORTERS, COSTING AND SELLING PRICE" PROGRAMME! £20.

All programmes include practical instructions! Tailored Software available. Packing & V.A.T. INCLUDED.

ACCESS COMPUTERS
2 Rose Yard, Maidstone, Kent ME14 1HN
Tel: Maid. (0622) 58356

• Circle No. 213

FLOPPY DISKETTES

5 1/4" and 8" single and double sided/density. Available from stock at competitive prices.



Also all other computer media and supplies, including

Cassettes
Ribbons
Print Wheels

Storage Systems
Computer Files
Stationery

Michael Collins Computer Supplies Limited
52, Canbury Passage, Kingston, Surrey.
Telephone: 01-549 9441

• Circle No. 214

**EXIDY
SORCERER**

GPW Your South Coast Dealer.
New low prices. Engineered systems. Word processing. Business applications.

48K	£849.00 + VAT
Micropolis Disc Drives for Tandy, Exidy, etc.	
143K	£339.00 + VAT
Tandy 315K	£399.00 + VAT
315K (inc. S-100 drive)	£ 699.00 + VAT
Exidy 630K (inc. S-100 drive)	£1159.00 + VAT

GPW ELECTRONICS LIMITED,
55 COBHAM ROAD,
FERNDOWN INDUSTRIAL ESTATE,
FERNDOWN, WIMBORNE,
DORSET
Telephone 0202 893838
Telex 417111

• Circle No. 215

**IBM GOLFBALL PRINTERS
From £425 + VAT**



Reconditioned printers with keyboard and RS232 interface.

Sales — Service — Supplies

AID Office Supplies
Brindlwell Ltd.,
Frampton Cotterell
BRISTOL
Telephone: (0454) 774564

• Circle No. 216

**apple II/ITT 2020
relocated integer**

Enables any Integer programme to run on an Apple II Plus/ITT Palsoft machine without an Integer card. Specify memory size when ordering.

Cassette Systems £12 Disc Systems £14

speed control

Adjustable text output speed using the game control paddle. Use to list/edit Integer, Floating Point, and Monitor programmes and also incorporate in your own programmes.

Supplied on Cassette £8

keypad

A low-cost numeric keypad which plugs into the game control connector. Complete with software routines for numeric input/menu selection/cursor control and with demonstration programme.

Kit of Parts £18 Assembled £26

D. J. BOLTON, 1 BRANCH RD, PARK STREET, ST. ALBANS. TEL: PARK STREET (0727) 72917.

• Circle No. 217

EAST ANGLIA

IPSWICH 210958

for

APPLE/ITT 2020

- SALES
- SUPPORT
- COMMITMENT

**CARDINAL DATA SYSTEMS
20 BUTTER MARKET
IPSWICH, SUFFOLK
IP1 1BP**

• Circle No. 218

BUYERS' GUIDE

The Buyers' Guide is a summary of low-cost computers available in this country. It appears each month; we add new computers and amend existing information, as required, to keep it up-to-date. Systems are listed by manufacturer.

As the Buyers' Guide is now being revised and updated in preparation for a new series which will appear on our Prestel pages, please send us information confirming the details contained in the entries and any new facts which you may possess.

ACORN COMPUTERS

Acorn. Single Eurocard-sized microcomputer with 6520 processor, 16K RAM, 16-way I/O. Max size; a second Eurocard adds hex keypad and CUTS cassette interface. Monitor and machine code programming now, Basic and disc operating system in the future. "Highly cost-effective basis for a computer or an industrial development system". Available from Acorn (0223) 312772 or Microdigital (051) 286 0707.

£74.75 kit, £86.25 assembled

ALAN PEARMAN LTD

Maple. Z-80A, 16- 64K RAM, S-100 bus, CP/M, Micro-APL and any CP/M languages, 8in. single/double-density discs, RS232 serial and parallel ports. APL(0244) 46024.

From £1,510

ALPHA MICROSYSTEMS

AM-1010, AM-1011, AM-1030, AM-1031, AM-1050, AM-1051: 64K-16MB RAM, WD16 — 16-bit — S-100 bus, Basic, Pascal, Lisp, Assembler, Fortran, floppy discs to 4 × 90Mbyte hard disc, RS232, up to 20 ports. AM(01-) 250 1616.

From £7,500 to £19,000

APPLE COMPUTERS

Apple II Plus. Min size: 16K memory, 8K ROM, keyboard monitors; mini assembler; colour graphics; Pal card; RF modulator; games; paddles and speakers; 4 demo cassettes. Max size; Expandable to 48K memory; floppy discs and printers are now available. Two versions of Basic, PASCAL; Assembler; games; business packages. An American system regarded as suitable for any kind of applications. Maintenance contracts offered. Microsense Computers is the sole U.K. distributor and has a national dealer network. Tel: (0442) 41191/48151 (24-hour answering service).

From £695.

ATTACHE

Attache: Min size: system with 10 slots, S100 bus, 8080 processor and 16KB housed in desk-top case with built-in keyboard. Max: 64KB, parallel printer interface, two single or double density 8" floppies, video screen. Disc Basic. Full business system includes all software. Sole U.K. distributor is Friargrove Systems Ltd. Tel: 01-353 3196.

From £1737. Full business system £7000

BASF

System 7100. CPU: Z-80A, 64K RAM, internal BASF, 5¼in. discs, single-sided, single-density, RS232, BOS BASF operating system, Basic assembler. Sole U.K. dealer MPR, Tel: Paul Curran 01-837 6332.

From £4,937

BILLINGS

Billings Microsystem (BMS): Z-80A, 64K RAM, 12" screen, QWERTY keyboard, range from double density 8" floppies (600KB), to 200 MB hard disc. Software includes COBOL (ANSI74 with extensions), FORTRAN, Extended BASIC and MAC80 Assembler. The microsystem could be used as a program development aid. Availability: Mitech Data System Ltd, Woking (04862) 23131.

From £4295

B L MICROELECTRONICS

Biproc. Z-80 or TMS9980 kit, 1K RAM expandable, 2K monitor plus line-by-line assembler, TTL receivers and drivers, RS232C to cassette or UHF modulator. BLM(0494) 443073.

From £150

BRUTECH ELECTRONICS

BEM-CPU1. Single-board processor with 6502 and no RAM. Applications software. Available from Data Precision Equipment (04862 67420). (Reviewed March, 1979)

£133 exc. VAT

BYTRONIX MICROCOMPUTERS

Megamicro. 8080A/Z-80 processor. 64K. Double-sided discs, two-page addressable VDU, 140 cps printer. Software includes Basic, Fortran, Cobol and Pascal, all running under CP/M. Applications include automatic letter writer, sales ledger and stock control, payroll and bought ledger. Self-diagnosis utilities. Aimed at business and university user. Available from Bytronix (0252) 775814.

From £6,080.

COMART

Microbox: Chassis with three to six PCB sockets for S100 boards, plus fan. Several S100 boards available. Aimed mainly at OEM industrial users and perhaps the serious hobbyist. It will take Cromenco, North Star and other processors. Available from Comart (0480) 215005.

£195

VDM Board: Adds word processing power to the S100 bus by providing on-board screen storage. Generates 16 by 64 character lines from data stored in a 1024 byte on-board memory.

£145

COMMODORE SYSTEMS DIVISION

Pet. Single unit containing screen, tape cassette and keyboard. Floppy disc, printer and full-size keyboard are options, as are external cassettes. Basic; games; business packages. The British subsidiary of Commodore Systems of the U.S. sells Pet for home, educational and small business applications. About 80 distributors.

£460-£795 exc VAT

Kim-1, processor (6502 chip); small calculator-type keyboard; LED six-digit display; built-in interfaces for audio-cassette and Tele-type; 1K RAM; 2K ROM (can add up to 64K). No software available, but it has three good manuals. An American import which gives Pet-type capabilities with a maximum configuration. For the hobbyist but used mainly as an evaluation board for the 6502 chip. Twelve to 15 dealers. (Reviewed October, 1978).

£99.95



SPEED — VERSATILITY — ECONOMY



Designed originally for logic wiring applications, it is now accepted and used extensively throughout industry, education and research. ROADRUNNER is used by hobbyists, students, technicians, designers and engineers, to carry out work on: — *P.C.B. REPAIRS *ANALOGUE BREADBOARDING *SIMPLE LOGIC WIRING *COMPLEX INTERCONNECTING OF MICROS AND MEMORIES.

EURO INTROKIT £15.73. PROJECT INTROKIT £8.50. PENCIL WITH LOADED BOBBIN £2.44. WIRE DISTRIBUTION STRIPS:— GLUE FIX 20/pkt 6" LONG £2.80. ADHESIVE 0-36/TUBE. PRESS FIX 20/pkt 2" LONG £2.92. SINGLE EUROCARD HIGH DENSITY 3 PLANE (36x16 PIN DILS) £4.50. DOUBLE EUROCARD, WITH CAPACITY OF 84x16 PIN DILS £7.25. PROJECT CARD HIGH DENSITY 5-SIDED 20x14 PIN DILS £2.85. BOBBINS - BLUE 4/pkt £2.12 GREEN 4/pkt £2.12 PINK 4/pkt £2.12 GOLD 4/pkt £2.12. 1 OF EACH COL. £2.20. TINNED COPPER WIRE 4/pkt £2.12. RECOMMENDED SOLDERING IRON FOR ROADRUNNER HOBBYIST £4.80.

Please add 40p for p&p + 15% VAT to all orders.

FOR FURTHER INFORMATION
ON ROADRUNNER PRODUCTS
SEND LARGE S.A.E. TO:—

T.J. BRINE ASSOCIATES,
56B, HIGH STREET, HASLEMERE,
SURREY.

• Circle No. 219

OHIO SCIENTIFIC NEWS FLASH

FULL RANGE OF
SUPERBOARDS TO C3's

Best prices, best backup, best service from an Ohio Scientific factory appointed dealer/importer. Riling us for latest prices on boards, accessories, expansion, software etc.

50Hz Superboard prices start

From £159 + VAT

C.T.S., 1 High Calderbrook
Littleborough
Lancs OL15 9NL

Tel: Littleborough (0706) 79332

ANYTIME

• Circle No. 220

ITT2020 SOFTWARE APPLE II

DATABASE is a program

that writes a program. DATABASE can create a flexible record-keeping system custom designed to YOUR specification.

HUNDREDS OF MEMBERSHIP DETAILS OF MEDICAL RECORDS APPLICATIONS MAILING LISTS, ETC a direct replacement for the CARD INDEX

Simply draw the format you require on the screen using the editor. Then let the computer do the rest! Easy to use. FEATURES: protected screen editing automatic date and number checking comprehensive search & print functions £120+VAT. for the complete system!

Phone 01-242-7394 or write for details

DISK DEAN LTD
23 BEDFORD ROW, LONDON WC1R 4EB

• Circle No. 221

SHOP WINDOW

APPLE & ITT2020 BUSINESS SOFTWARE

Professionally written packages now available with comprehensive manuals, built-in validity checks, interactive enquiry facilities, user options, satisfying accountancy, Inland Revenue and Customs & Excise requirements. On diskette under DOS 3.2. in Applesoft with SPACE utility. Not adaptations. Written for Apple System. Support all printer interfaces. Sales, Purchases and General Ledgers £295.00 each.

Manual only £3.

Payroll £375. Manual only £4.

General Ledger supports Incomplete Records, Job Costing, Branch and Consolidated Accounts etc.

General Ledger Applications Manual £10.

Prices exclusive of V.A.T. From our shop or your nearest stockist.

COMPUTECH SYSTEMS

168, Flatchley Road, London, N.W.3.

Tel: 01-794 0202

• Circle No. 222

TRS-80 Disc System

Microfloppy disc system giving up to ¼M bytes per disc side and directly compatible with Tandy TRS-80 and Schugart SA400 drives.

Complete self contained unit in smart black case with internal power supply. Trade enquiries only please.

COMPUTER INSTRUMENTATION LTD.
Chandlers Ford, Eastleigh, Hants.,
England, SO5 3YY.
Tel. (04215) 66321. Telex 47326.

• Circle No. 223

MICROLINE 80

A revolution in small matrix printers. High quality print, Tandy/Prestel graphics, 3 print sizes, line programmable. Standard version has both friction and pin feed.

Centronics input interface. Options: Tractor feed, Serial interface.

Standard model (inc paper dispenser)

£499.00 + VAT

Tractor feed £ 35.00 + VAT

Serial interface £ 65.00 + VAT

GPW ELECTRONICS LIMITED,

55 COBHAM ROAD,

FERNDOWN INDUSTRIAL ESTATE,

WIMBORNE, DORSET

Telephone 0202 893838

Telex 417111

• Circle No. 224

FOR NASCOM 1_2

ADD EXTRA SCREEN CONTROL TO YOUR NASCOM. BLANKS SCREEN LEAVES VIDEO RAM CONTENTS UNCHANGED.

SCREEN WHITE WITH BLACK LETTERING AND GRAPHICS. ALL UNDER SOFT WARE CONTROL BY ALL MONITORS AND BASIC.

PLUGS INTO NASBUS NO MODIFICATIONS REQUIRED TO NASCOM. KIT CONTAINS PCB WITH GOLD EDGE CONNECTOR, LOW POWER IC'S SOCKETS, WIRE, AND CONSTRUCTION MANUAL. FOUR DECODED OUTPUTS ARE ALSO PROVIDED.

S.A.E. FOR FULL SPECIFICATION.

KIT £27.00

INC. POST & PACKING

R. W. ELECTRONICS

27 THE VINERIES

ACOCKS GREEN

BIRMINGHAM

B27 6SB

MAIL ORDER ONLY

• Circle No. 225

COMPUCOLOR

Compucolor II. Packaged system including 13in. eight-colour display with alphanumeric and graphics, 72-key detachable keyboard, 8KB, and built-in mini-floppy. Max size: 32KB. Extended disc. Basic in ROM, graphics programs and games. The system now ranks fourth behind Pet, TRS-80 and Apple in personal computer sales. Abacus (01-580 8841) is sole U.K. agent and is arranging distributors, including the Byte Shop and Transam. (Reviewed June, 1979).

From £1,390

COMPUCORP

610: desk-top unit using Z-80 and incorporating screen, 150KB floppy, 48KB. Up to 60 KB memory, four floppies, printers. Basic, Assembler, DOS, text editor, file manager; business packages. Nine dealers.

From £3,890

COMPUTER CENTRE

Mini kit: Z-80 CPU, CTC, USART, serial and parallel I/O, 16 bytes memory, Western Digital disc controller, SA400 5in. drive plus CP/M, cables and connectors.

Mini kit: £786

Maxi kit: As above but with DRI 7100 8in. drive instead of 5in. drive. All (33) volumes of CP/M user group library available for cost of media. Library includes utilities, games. Basic compilers/interpreters and Algol compiler. Microsoft Basic, Cobol, Fortran also available. Computer Centre (02514 29607).

Maxi kit: £886

COMPUTER WORKSHOP

System 1. Typical size: 40K memory; dual 8in. floppy disc, total storage capacity 1.2MB; Ricoh daisywheel printer.

System 1, £5,000 plus

System 2. Typical size: 24K memory; dual minifloppy discs of 80K bytes each; Centronics 779 dot matrix printer; VDU.

System 2, around £3,000

System 3. 12K memory, cassette interface: 40-column dot matrix printer. Editors, Assemblers, Basic, games, information retrieval package. The systems were designed and built in Peterborough and are suitable for educational and small business users and perhaps the more serious hobbyist. Twenty-five dealers.

System 3, from £1,300

CROMEMCO

Single-card computer: 4MHz Z-80 CPU, S-100 bus, 1KB RAM, sockets for 8K ROM, 20mA/RS232 serial interface and parallel bidirectional interface. Basic in ROM and Z-80 monitor. For OEM and industrial users; used with backplane for "full computer compatibility" (Reviewed February 1979).

£225 (in kit form) to £260

Z-2: Min. size: chassis, 31A power supply, motherboard, Z-80 processor, 16KB memory. Max size: 512KB, 21 sockets, three mini-floppies or four 8in. floppies. Basic, Fortran, Cobol, assemblers. For serious hobbyists, OEMs, educational applications, and industrial/scientific users.

£360 (in kit form) to £3700

System Two. 4MHz Z-80A, 64K/512K RAM, S-100 bus — 21 slots — CP/M, Fortran, structured Basic, Cobol, Assembler, DBMS, RS232 serial interface, parallel printer interface, daisywheel printer interface — standard — multi-channel interfaces available — digital and analogue — VDU, two 5¼in. floppy disc drives — 180Kbyte each, hard disc up to 70 MB.

£587 £2,126

System Three. 4MHz Z-80A, 64K-512K RAM, S-100 bus — 21 slots — CP/M, Fortran, structured Basic, Cobol, Assembler, two or four 8in. disc drives — 512Kbytes each — hard disc up to 70MB; ports as above. Sold by Microcentre (031) 556 7354 and Comart.

£2,995 to more than £8,000



DATA APPLICATIONS

DAI Personal computer. 8-48K RAM, 24K fast Basic + systems programs ROM, colour graphics — variable to 255 × 355 — PAL output to TV/monitor, compatible with more than 20 Eurocard Industrial Interface Modules, upper- and lower-case QWERTY KB, RS232 interface included, machine code utility, scrolling screen editor, 3 oscillators with volume control, to TV or stereo, 60-character screen width, dual cassette interfaces, 6-game paddle inputs. Sole U.K. Dealer: Data Applications Ltd, 168 Dyer Stret, Cirencester, Gloucestershire, GL7 2PF.

From £998

DIGITAL MICRO SYSTEMS

DSC-2. 64K RAM Z-80A and more than 1MB on two Shugart 8in. disc drives, four programmable RS232 and one V24 parallel interface. CP/M and Basic included in price. Additional utilities available including Z-80 code assemblers and re-locating loaders file sorting, text and word processing. High-level languages available include C Basic 2, Cobol, Fortran, and Pascal. Add-on 14MB and 28MB disc-system available.

From £4,695

HDS 4000. Floppy/hard disc microcomputer, 64K RAM more than 1MB or optional more than 2MB on 2 Shugart 8in. floppy disc drives and 13.7MB or optional 27.4MB Winchester technology hard disc. All enclosed in one cabinet, and includes standard CP/M operating system. Sole U.K. distributor: Modata (0892) 41555.

From £8,995
(13.7MB)
£10,195
(27.4MB)

DYLE HOUSE

Business Computing System 2000. Z-80A. Dual 8in. discs, 140 cps 132 char printer. Dyle House Business Basic, and disc operating system. Accountancy, payroll and parts control suites, Applications: Sales acknowledgments, sales invoices, delivery notes, purchase orders, customer statements, remittance advice. Dyle House Ltd (01-529 2436).

No price
announced

EACA

Video Genie EG3003. Z-80, 16K-48K RAM, S-100 bus via expansion box, Microsoft-compatible operating system in 12K, CP/M 5¼in. floppy discs via expansion box, all address and data lines from CPU, RS232. Lowe Electronics (0629) 2430.

£369.56

EQUINOX

Equinox 300. Min size; 48K memory; dual floppy discs giving 600K bytes of storage; 16-bit Western Digital m.p.u. Max size; up to 256K memory; up to four 10MB hard discs. Basic, Lisp, PASCAL, Macro Assembler, Text Processor. All software bundled. The system is a multi-user, multi-tasking, time-sharing system for two to 12 users. Application software available for general commercial users. Sole distributors Equinox Computers Ltd (01-739 2387).

£5,000-£40,000
plus

EURO-CALC

Euroc: 8080A CPU, 64KRAM, two times double-sided single-density 8" floppy disc drives with approximately 1 MByte capacity. 15" screen with 80 by 25 characters, QWERTY keyboard, CP/M operating system 140 CPM tractor feed matrix printer. Software: C-BASIC 2. Supplied with accountancy package for sales, purchases and nominal ledgers and initial stationery. Sold through Euro-Calc, 55/56 High Holborn, London W.C.1. Tel: 01-405 3113.

£8,000

EXIDY

Sorcerer: based on Z-80, 16K and 32K; cartridge and cassette interfaces; 79-key keyboard; 256-character set (128 graphics symbols), 12in. video monitor; expandable with Micropolis floppy discs. Basic, Assembler and Editor; games, word processor. Other pre-packaged programs plus EPROM Pack for your own programs on cartridges. Factor One is sole distributor for U.K. (Reviewed March, 1979).

From £760
without VDU to
£1,200 with
floppy discs

ITT/APPLE 2020

£650

DEMONSTRATIONS GIVEN
SUPPLY SOFTWARE AND ALL
ACCESSORIES.

HAYDALE ELECTRONICS
18 BASSEIN PARK ROAD
LONDON W12. 01-788 0397

• Circle No. 226

NEW! NEW! NEW! NEW! NASCOMS 1 & 2 D/A NASBUS BOARD

two 8 bit converters, full scale
outputs 2.5 - 5.0V.

from £69.50

INPUT/OUTPUT BOARD

up to 5 PIO devices

for more details SAE.

BING SYSTEMS, 8 Glen Rd,
Bingley, West Yorks, BD16 3ET.

• Circle No. 227

ANCO COMPUTER SERVICES LTD.

We offer a complete service.
We are agents for the Z-Plus
Microcomputer System.
We can supply a wide range of
packages — Payroll/Purchase
Ledger etc. We provide full
consultancy and Software
Service.

4 Benton Road
Hf,ord Essex IG1 4AT
01-554 4164 (24 hrs)

• Circle No. 228

Vets for Pets

Anita Electronic Services (London) Ltd.
are specialists in the repair and service of
Commodore Pets.

We offer a fast on-site service, or alternatively repairs can be carried-out at our workshops should you wish to bring in your Pet.

Pet maintenance contracts are available at very competitive prices. Trade inquiries welcomed.

For further information tel. or write to:-

• We also specialise in the repair of all makes of office equipment.

John Meade
Anita Electronic Services,
15 Clerkenwell Close, London EC1
01-253 2444

WORD-PROCESSING

written by C.B.C. for

APPLE & ITT 2020

cassette: £20 disc: £26 + VAT

incl. Documentation. For Anadex, Centronics etc.

Send Cash, Cheques, P.O. or Access/Barclay No. for £23/£30 (incl. VAT and P&P) to:

MILDMAY ELECTRONICS (Dept. A)
200, Moulsham St., Chelmsford, Essex

• Circle No. 229

EPROMPT ERASER



• CLEARS UP TO 32 CHIPS IN 30 MINS ON 200-250V A.C. •

• CONTINUOUS 253.7m BEAM. SAFE & SIMPLE. GUARANTEED •

• £39 C.W.O. £40 NETTY 30 DAYS: ALL INCLUSIVE! •

TRADE ENQUIRIES INVITED FOR SUBSTANTIAL DISCOUNTS
ALL ORDERS AND ENQUIRIES POST-FREE TO:

TEX MICROSYSTEMS LTD.

FREEPOST, ST. ALBANS, HERTS. AL1 1BR
ST. ALBANS 94077 / TRING 4797

PET HIRE SOUTHAMPTON

Weekly charges:

8K small keyboard £20

8K large keyboard £23

16K £27 32K £32

Printer £35

Floppy Disk £35

All include manuals, Tutorials, MICRO-CHESSE, INVADERS (Arcade version).
Soundbox £2 extra. Prices exclude VAT.

2 weeks hire offset against purchase.

£50 software with purchase of computer.

Official Commodore Dealer

SUPER-VISION
13 St James Road
Shirley

Southampton
Telephone (0703) 774023
After hours (0703) 554488

• Circle No. 230

Business Systems Systems Development

Programs designed and written for North Star and CP/M computer systems.

Consultancy

*Feasibility studies

*Implementation assistance

*Independent advice

We specialise in accounting, order processing, invoicing and stock control systems.

Mc Millan Computing Services
3 Tithelbarn Grove
Calcot, Reading
Tel: 0734 414751 (Ansafone service)

• Circle No. 231

HEATH SCHLUMBERGER

H8. 8080 CPU. 4664K PAM. Serial/cassette I/O; front parallel monitor; keypad; optional parallel I/O; serial multiport; breadboard I/O and disc system. Basic, Ext. Basic, Microsoft Basic, HDOS, CPM.

From £262 (in kit form)

WH89. All-in-one computer Z-80 processor plus Z-80-controlled VDU. 16K expandable to 38K, user-accessable. Two RS232 I/O ports. Operating system includes Benton Harbour Basic, two-pass absolute assembler, text editor, utility programs, Microsoft Basic and Fortran word processor package. Heath Schlumberger (0452 29451).

About £1,600

HEWART MICROELECTRONICS

Mini 6800 Mk II. IK monitor; IK user RAM, IK VDU RAM; CUTS. Upper- and lower-case VDU with graphics option. 128-byte scratchpad; decoder/buffer; power supply; Basic in ROM; monitor command summery. SWTPC programs; Newbear 6800; Scelbi 6800 Cookbook. Markets are small business, education and home user. Cash with order to Hewart. (0625) 22030.

From £127.50 plus VAT

6800S. 16K dynamic RAM; IK Mikbug-compatible monitor; room for 8K Basic in ROM; upper- and lower-case graphics; single floppy disc drive; printer and high-speed tape interfaces. "Mountains of software available." Test tape with CUTS test tones, test message and games with kit.

From £275 plus VAT

IMSAI

VDP 40: 32K or 64K RAM memroy; 9in. display screen, standard keyboard. Two 5¼in. floppy disc drives; serial I/O. Full software support, and packages available for the VDP 42, which has larger disc capacity. Packages for VDP 80 could be converted for smaller systems. This would be from about £700 per package. Two main dealers in the country.

£4,507 for 32K model. £4,950 for VDP 42

INTERTEC

Superbrain. CPU Z-80A, 64Kbytes, RAM, 256bytes static RAM, 1Kbytes ROM, floppy disc storage capacity formatted on 2 Shugart double-density drives, optional external 10 to 300 megabyte hard disc storage using optional 5100 bus adaptor, RS232, CPM, Microsoft M Basic 5, Cobol, Fortran, C Basic. 4 U.K. distributors.

From £1,950

ITT

2020. Identical to Apple II. Min. size: 4K memory; 8K ROM; keyboard, monitor, colour graphics, mini assembler; Powell card; RF Modulator, games, paddles and speaker; Max size: 48K with floppy discs and printers. Basic, Assembler, games, business packages. Generally suited to any type of application. Fifteen wholesalers, including Fairhurst Instruments.

From £827 to £3,003 for 48K, two floppies and Printer

KEMITRON ELECTRONICS

UBS 3000. Z-80, 1K to 64K RAM, Kemitron bus, operating system from 1K machine code monitor in ROM to full disc system, CP/M, Basic, Fortran, APL, Pascal, 5¼in., 8in. and hard discs, as many ports as required up to 256. Kemitron (0244) 21817.

Bareboards from £640 rising to £4,000 for full system

LUXOR

ABC 80. Min size: 35K with keyboard, CPU 12in. screen and cassette. Max size: 40K RAM with discs. Z-80 processor, loudspeaker with 128 effects, real-time clock. Options: printers, plotter, discs, module cards, digitiser, modem. 60 compatible I/O memory boards. Software: Basic with resident editor; assembler; games; business and educational packages. Personal computer aimed at home market, small business and education. CCS Microsales is U.K. agent and is looking for distributors.

£795 plus VAT

MICROMATION

Z-Plus Systems 1.2.10 and 20. Z-80, 64K RAM, S-100 bus, CP/M(3), MP/M(14) Cobol, MBasic, Fortran, APL, PL/1, Pascal, floppy discs and 8in. and 14in. hard, two serial and six parallel ports. Rostronics 01-870 4805.

£3,950-£8,550



MICRONEX

Pixelplotter MX-100. Z-80A, 64Kbytes program plus 32Kbytes graphics store, program store expandable in 74Kbytes increments to 16MB, S-100 bus, CP/M — 2.0 FDOS standard — Pixel graphics display system, 8in. dual drives, option of 5MB cartridge disc and 5MB fixed platter, four parallel and three serial RS232. Micronex 027-589 3042.

From £3,485

MICRONICS

Micros. Typical size: 1K monitor; 47-key solid state keyboard; interfaces for video, cassette, printer and UHF TV, serial I/O, dual parallel I/O parts; 2K RAM; power supply. 2K Basic; British-designed and manufactured system. Claimed to be the cheapest data terminal — a system with an acoustic coupler and VDU for £1,020. Prospective applications for small businesses, process controllers and hobbyists. Manufacturer is sole distributor (01-892 7044).

From £400,
assembled

MICRO V

Microstar. Single box with twin 8in. floppy discs, 64K RAM, three RS232 serial inputs, STARDOS operating system enables system to have three VDUs, plus a fourth job running simultaneously. Word processing software available. Packages being developed include invoicing system, payroll, accountancy type system. Price includes a reporter generator language. Imported by a Data Efficiency subsidiary, Microsense Computers, Microsolve is London agent; other distributors being arranged.

£4,950 machine
and software

MIDWEST SCIENTIFIC INSTRUMENTS

MSI 6800. Min size: 16K memory Act I terminal; cassette interface. Max size: three disc systems — minifloppy system with triple drives of 80 bytes each and 32K memory, large floppy system with up to four 312K-byte discs and 56K of memory mounted in a pedestal desk, or hard disc system with 10MB and 56K. Basic interpreter and compiler; editor; assembler; text processor on small disc system. American-designed system being manufactured increasingly in the U.K.

Basic system:
£1,100 (£815 as
kit); *Minidisc,*
£2,500; *floppy*
disc £3,200; *hard*
disc, £8,000-
£12,000

From £4,500

MSI 6800A System 7. 56K RAM. Dual micropolis mini-floppy disc drives each with the capability of storing 320Kbytes of information, and runs as a standard 3 operating system: Flex, MSI, DOS, SDOS, full supporting system software is available for each of the three operating systems.

System 10. System 7 with 107B hard disc. Sole U.K. agent is Strumech (SEED). Tel: (05433) 4321.

MODULAR BUSINESS SYSTEMS

Tutor. 8085A, 32-64K, Intel Multibus, CPM, 2K ROM bootstrap loader — transparent — option of 512 × 250 graphics, 2 × 164K 5¼in. floppy discs expandable to 4 × 256K 8in. Two serial RS232C ports, 24-bit parallel TTL programmable port.

From £2,500

Elite. 8085A/8086/series 3000 bit slice, 32-256KRAM, Intel Multibus, CPM, 2KROM bootstrap loader — transparent — 512 by 250 graphics, 5¼in. floppy discs to 24MB hard, RS232 and 24-bit TTL programmable port. MSBL (0532) 505719.

From £5,400 to
£25,000

NASCOM MICROCOMPUTERS

Nascom 1. Min size: CPU; 2K memory; parallel I/O; serial data interface; 1K monitor in EPROM. Max size: CPU, 64K memory, up to 16 parallel I/O ports. Mostly games, but also a dedicated text editor system written by ICL Dataskil. Nascom is working on large versions of Basic, and 8K Microsoft Basic should be available soon. Eleven distributors in U.K. Nascom is negotiating to increase the number. (Reviewed January, 1979).

£165 exc VAT

Nascom 2. Z-80A, 1K RAM, Nasbus, 8K Basic and 2K monitor plus 2K character generator, Basic and assembler, low- and high-resolution and colour graphics, 5¼in. single or twin floppy discs, parallel port, serial port RS232, one Kansas City cassette port. Nascom (04427) 74343.

From £295

ELEY ELECTRONICS

AGENTS FOR NASCOM &
VIDEO GENIE

SPECIAL OFFERS FOR CALLERS

8 Hole Paper Tape Punches: £4

8 Hole Optical Tape Readers: £8/£12

Electric Typewriters From: £7.50-£130

Video Monitors From: £10-£35

MEMORY PRICES SLASHED

8 × 4116 = (16K, 250 N/S): £36

2102 (450 N/S): 60p

STAR OFFER

2716 EPROM (2K × 8): £7.50

Please Add Carriage + 15% VAT.

100/104, Beatrix Rd., Leicester.

COMPUTERMANIA
BADGAINS

ITT 2020 : 15K RAM, FULL COLOUR, CASSETTE / TV /
VIDEO INTERFACES, LOUDSPEAKER ETC.
A FANTASTIC £ 950 !!

MINIWORD LANGUAGE COMPUTER: Hundreds of useful words
and phrases in 6 languages at your fingertips.
Module to convert to calculator, filing system,
over the summer Olympics records and statistics.
Price includes battery charger & carrying case.
YOURS for ONLY £199

Compucolour II • Built in MINIFLOPPY 2K user RAM £995.00
• 13" COLOUR MONITOR 32K user RAM £1100.00

THE PRIORITY GREAT MILTON, OXON OX9 7BP
TELEPHONE: 08 448 729 TELEX: 83147 - REFER 'CMPA'

TRS-80

HIGH
PERFORMANCE
MODULE

Increase the speed and power of your
TANDY TRS-80 Level II
by

50% TO 100%

EFFICIENT
INTERNAL MODIFICATION

Send for full details to
CENTRAL BUSINESS ASSOCIATES
P O Box 14
EPSOM, Surrey.

KIT: £30

Excl. VAT **FITTED: £55**

ITT Apple 2020 (Palsoft + Colour)

BASIC SYSTEM from £867.00
BUSINESS SYSTEM from £2,400.00
also

a range of printers & VDU's including
DIABLO DAISYWHEEL printers
from £1740.00

Larger Business systems
also available.

Sales — Service — Supplies

BRINDIWELL LTD
Frampton Cotterell
BRISTOL

Tel: Winterbourne (0454) 774564

SHOP WINDOW

Are You A Microperson?

We are an expanding systems and software house in the Ilford area and are seeking enthusiastic sales and service staff.

Our product lines are based on both APPLE II and CROMEMCO HARDWARE. We will train in programming if this area interests you.

Salary by agreement dependent on experience.

BENEFIT PACKAGE INCLUDES:

- Car
- Profit Sharing
- Equity Participation Scheme

Please phone us on 554 8059 (anytime)

COMPUKIT/SUPERBOARD OWNER?

BRAD612743

TUNES, ROBOTS, LIGHT PEN
JOYSTICKS, REMOTE CONTROL?

- All possible with our 24 line I/O Port.

- Delivery ex. stock.
- On board relay.
- 40 pin socket for further expansion.
- Even 2 buffer chips (8T28) supplied.
- Plugs straight in - no extras.
- Full manual with software examples.

■ £35 Kit | Inc. V.A.T.
■ £40 Built | and P&P

N. Hepworth, 7 Greycourt Close,
Idle, Bradford, Yorks. BD10 8QJ

Modata

Digital Microsystems

OVERPRICED COMPUTERS INADEQUATE PERSONAL MICROS?

Modata supply Dealers and OEMs with Digital Microsystems competitively priced Single and Multi-User computers which include Reliable Floppy and Hard Disk storage.

ie. DSC-2: Z80 at 4MHz + 64Kb +
2 x SSDD 8" Floppies for 1Mb + CP/M
+ £3525 E.U.

WHY NOT FIND OUT MORE?
0892 41555

Modata Ltd. 30 St. Johns Road,
Tunbridge Wells, Kent TN4 9NT

NATIONAL MULTIPLEX

Pegasus. Min size: 48K, Z-80; double-density floppies (320KB); S100 bus; 12in. CRT; 58-key keyboard; two serial and one parallel interfaces; bi-directional printer. Options: 8in. drives; 1-2MB additional drives; digital recorder 9,600 baud. Assembler, Cobol, Fortran, Extended Basic, General business package available as well as text editing and mailing list. All run under CP/M. Suitable for education, business and home users. London Computer Store (01-388 5721) sole supplier.

£2,700 exc VAT

NETRONICS

Elf II: single-board computer in kit form or assembled, RCA Cosmac 1802 processor, hex keyboard, 256 bytes RAM; options include up to 64KB, ASCII keyboard, cassette and RS232 I/O, and video output. Machine code or Tiny Basic. Promoted as a teaching system in minimal form, but expandable for more general use. Sole U.K. distributor HL Audio (01-739 1582).

Basic kit £79.95.
Assembled
£99.95 I/O board
£35

Explorer 85: Min size: 4K. Max size: 64K. 8085A processor, VDU board, ASCII Keyboard, S100 expansion. Cassette, RS232, TTY interface on board. I/O ports, programmable timer. Disc software, Microsoft Basic on cassette, 8080 and Z-80 software can be used. Aimed at hobbyist, OEM and small business. Available from Netronics (computer division of HL Audio).

From £297 plus
VAT

NEWBEAR

7768: CPU board, 4K memory, cassette and VDU interfaces. Range of Basics and games. British manufactured system for hobbyists. Expandable to 64K memory available only in kit form. From Newbear in Newbury and Stockport.

From £45

NORTH STAR

Horizon. Min size: 16K memory; Z-80A processor, single minifloppy disc drive (180KB). max size: 56K memory, four minifloppy disc drives (180KB), any acceptable S100 peripheral boards. Basic (includes random and sequential access), disc operating system and monitor. Options: Basic Compiler, Fortran, Cobol, Pilot, PASCAL and ISAM. The system is suitable for commercial, education and scientific applications. Application software for general commercial users. Twenty distributors. (Reviewed April, 1979).

£995 to £2,500

OHIO SCIENTIFIC

Ohio Superboard II. Min size: 6502 processor, 8K Basic in ROM; 2K monitor in ROM; 4K RAM; Cassette I/F, full keyboard; 32 x 32 video I/F, 8K Basic in ROM, Assembler/Editor; American single-board system with in-board keyboard. Aimed at hobbyist/small business. Ohio makes games, personal maths tutors, and business programs. This and other Ohio products have six U.K. distributors. (Reviewed June, 1979).

From £150

Challenger Range. 6502, Z-80 and 6800, 4K-56K RAM, OSI 48-line bus, 2K Basic support and 8K Microsoft Basic, 161 fixed graphics characters, 5 1/4in., 8in. and 10-74MB hard disc, up to 16 ports. CTS (0706) 79332.

£155 to £7,500

PANASONIC

Panasonic. 8085 CPU; Integral 24 x 80 video. Full keyboard with 21 programmable control keys, 10-key numeric pad, cursor controls. 3 x RS232 I/O channels, dual-floppy integral discs. 56K RAM, 4-channel DMA, models vary as to disc drives. JU 700 2 x 5 1/4in. SD/SS = 140K £4,150, JU 740 2 x 5 1/4in. DD/DS = 580K £4,500, JU800 2 x 8in. SD/SS = 500K £4,750, JU840 2 x 8in. DD/DS = 2MB £5,500. Main U.K. dealers: Panasonic Business Systems 01-262 3121.

From £4,150



PERTEC

System 1300. Min size: 32K memory; dual minifloppy discs 71 bytes each, formatted; serial interfaces. Max size: 64K memory; four serial parts. Basic (single and multi-user), Fortran, Cobol. The hardware for compelec Altair systems is from Pertec but the software is Anglo-Dutch. Sole distributor Compelec (01-580 6296).

£3,000-£5,000

PROCESSOR TECHNOLOGY

Sol. 808-based S100 microcomputer packaged with cassette and video interfaces (including graphics), keyboard with numeric pad, and 16KB RAM. Basic, assembler, word processors. Floppy disc systems available. Several distributors including Comart (0480 215005), which can offer nationwide maintenance contracts. (Reviewed July, 1979).

From £1,750
(excluding monitor
and cassette).
Complete floppy
disc systems with
word processing
about £5,000

RAIR

Black Box. Min size: 32K memory dual minifloppy discs, 80K bytes each; two programmable serial I/O interfaces. Max size: 64K memory; eight serial interfaces; 1MB disc storage (or 10MB hard disc); range of peripherals. Basic, Fortran IV, Cobol. Hardware distributors are being signed and agreements made with software houses to add software. A warranty and U.K. wide on-site maintenance is given. From manufacturer (01-836 4663) and systems houses.

From £2,300

RESEARCH MACHINES LTD

380-Z. Min size: 4K memory; 380-Z processor, keyboard. Max size: 56K memory. Options: cassette, single or dual minifloppy discs, dual 8in. double-sided discs (1MB); serial interfaces; parallel interfaces; analogue interface; printer available. Basic Interpreter, Z-80 Assembler; interactive text editor; terminal mode software; data logging routines; CP/M, DOS, text processor, CBasic, Fortran, Algol, Pilot, Cobol, CP/M users' club library. Sold principally to higher and secondary education, and for scientific research, data processing and data logging. Available from Sintel and the manufacturer. (Reviewed December, 1978).

From £830-£3,500

280-Z. Board version of 380-Z system, 4K or 32K (identical in performance to the 380-Z). Interfaces; software as for 380-Z.

4KB version at
£722

RCA

Cosmac. 1802 micro with hex keypad and output to TV screen. Assembler and Machine code programming; options include Tiny Basic. Available by mail order from HL Audio (01-739 1582).

Kit £79.95
Assembled £99.95
exc VAT

ROCKWELL

Aim-65. Kim-compatible with full keyboard and on-board printer. 1K or 4K RAM. The 4K version is described as a development system rather than a personal computer. Assembler, editor, Basic. Available from Pelco, Microdigital and Portable Microsystems. (Reviewed July, 1979.)

1K - £249.50
4K - £315

SCIENCE OF CAMBRIDGE

Mk 14. SC/MP processor, 256 bytes user memory; 512-byte PROM with monitor program; hex keyboard and eight-digit, seven-segment display; interface circuitry; 5V regulator on board. To this can be added: ¼K RAM (£3.60); 16 I/O chip. (£7.80); cassette interface kit (£5.95); cassette interface and replacement monitor (£78.95); PROM Programmer (£9.95). No software provided but a 100-page manual includes a number which will fit into 256 bytes covering monitors, maths, electronics systems, music and miscellaneous. Based on American National Semiconductor chips. Science will soon have a VDU Interface and large manual on user programming. Mail order from manufacturer (0223 312919) and by selected dealers. (Reviewed May, 1979).

£39.95 basic

LOGICAL COMPUTING APPLE & IIT 2020 SOFTWARE

Basic Tutorial tape	£15	General Maths	£10
Biorhythms	£5	Fourier transforms	£5
Linear Differential eqns	£6	(send for full list)	

FLUID FLOW PROGRAMS

(Boundary Elements)
Potential flow £150, Diffraction/
Acoustics £200

Book and user manual supplied

FINITE ELEMENT SYSTEM under development software can be written to suit customers complete engineering systems available (send for details, 6 Cranbury Place, SOUTHAMPTON, SO2 0LG)

**ENGINEERING, SCIENTIFIC
AND MATHEMATICS SOFTWARE**

MICRO ADS

are accepted from private readers only, pre-paid and in writing. 20p per word, minimum charge £2.

Nanocomputer plus power supply, unused. £240 o.n.o. Phone John Reid, Aylesbury 86500 (work hours).

Acorn System I, (6502), Hex keyboard, 7 Seg. display, cassette interface, PSU, for machine code programming. £80. — 059682 345.

APPLE II SOFTWARE On screen shape designer/shapetable maker. Excellent program. Big timesaver. £5. G. Kennett, 5 Bramdean Gardens, Lee, London SE12.

Unused Thomas Electronic Organ, cost £600 (Exchange value negotiable) offered in full or part exchange for micro-computer. Ring 0253 36646. If no reply evenings ring mornings and vice versa (Shift worker).

TRS-80 Level I 16K RAM For Sale. Numerous games tapes, manuals, tape player. Plugs straight into your own TV. Worth over £600. Offers around £420. Almost new, still boxed. Phone: 01-668 6450 Evenings.

EXIDY SORCEROR 32K with BASIC rompac, video, manuals, games cassettes, etc. Bought June 1979. Used only by owner. £800 o.n.o. R. Cullyer, Chandler's Ford. 69565 after 6 p.m.

OSI Superboard + UK101. Programs — Startrek*, 3D Space Maze* (£3.00); Tank Battle, Zombies, Life (£2.50); Disassembler, Bioplan (£2.00) and many more. Peripheral Interface kit comprising Cassette Control Unit + Parallel Port + Programmable Sound Generator — £48.95. (*not available for UK101). Velvet Software, 26 Colesbourne Close, Worcester.

Nascom 1. 8K Microsoft Basic, 16K Memory, Vero Case, Keyboard Cabinet, PSU. Documentation . . . £325 o.n.o. Phone 0704 28472.

KITS MY HOBBY! Ultimatum from wife — Sell! Nascom II £180 ZX80 £85 SWTEC £8 £600 Heathkit HW14 £350 7768 Boards half-price many S100 boards two thirds price, Aim 65 VIM I KTM 2 all two thirds, 9900 CPU board £100, Cherry Keys 15p. Softy £80, 8K Memory Board 32/64 Pin Male Socket £60, almost new Scopex 4D25 oscilloscope £400, no offers. Gem 365L organ £350. Loads TTL chips, no fish, could possibly arrange payment Barclaycard. Phone Bedford 46032.

Texas Instruments TI-58 Programmable calculator with technical books. £50. 13 Rectory Drive, Wootton Bridge, I.O.W. Tel: 0983 882801.

Sorcerer 32K + Development pack + TV Interface. £595. Tel: Reigate 48906.



SHOP WINDOW

Applesoft Card £75; Apple Language Card (Pascal) unused £180; Autostart ROM£18. Tel: 01-898 6621 Evenings.

ASR33 TELETYPE £220, Cossol VDU £85, TTY35 Printer £28, IBM selectric printer £175, phone Edinburgh 031-669 3758.

8K Pet virtually unused £400 o.n.o. With renewed service contract £450. David, Evenings 02514-20812 (Fleet).

NASCOM 1, 2 memory boards. 40K memory 2400 Baud cassette, case, Beefy Power Supply £300. Blackpool 692261 or 67091.

PLEASED WITH YOUR COMPUTER? As a business aid it can almost certainly do more. Send brief outline of requirements: Maurice Tait, Systems Contractor, 11a Old Town Street, Plymouth. (0752 21851, 0626 5815).

FED UP WITH YOUR COMPUTER? Bad for your business? Maybe I can help. Send outline of problem to Maurice Tait, Systems Contractor, 11a Old Town Street, Plymouth.

ICL VDU and KEYBOARD type 7181, 2000 character screen, full cursor control, modem and printer interfaces, workshop manual. £450 ono 051-424 7280.

GAMES CASSETTES FOR PET: Tower Game; Animated Snap (good graphics); Hangman — £3 inc. each. Boggle Game; Hungarian Cube Simulation — £2.50 inc. each. Others available (SAE for details). B. Cashdan, 36 Sterndale Road, Sheffield S7 2LD.

PET 32K SYSTEM FOR SALE, includes Toolkit, Cassette, Pet Cover and over 30 taped games plus EPSON TX-80 printer — prints full Pet graphics; system only four months old, any offer considered. Tel: 01-907 7785.

ICL 7075 KSR Termiprinter for sale. RS232 Interface. 10/20/30 Char/Sec selectable. Full terminal keyboard, modem interface. Bargain £475 with spare ribbons. Reading 23145.

FOR SLAE: KIM1 (6502 micro, 2K ROM, 1K RAM, hex keyboard, 6 digit display, teletype and cassette interfaces), KIM4 motherboard, 2 x KM-8B 8K RAM, MICROSOFT BASIC cassette, manuals and power supply: all £275: Ph. Winterbourne Gunner (Wilts.) 640

COMPUTER DUST COVERS. Integral cover for micro and monitor, grey or navy £6.00 post free. State make of micro and monitor. Money refund guarantee. M. Taylor, 7 The Pingle, Slitting Mill, Rugeley, Staffs.

NASCOM 2, 16K R.A.M. fitted in Vero Case. Several Programs and full documentation on Nascom. £400.00 Bishops Stortford 0279-504000.

Almost a handheld computer the TI-59 Programmable Calculator only £95. Telephone (03317) 4156.

Second hand programmes bought (not copies) suitable for new 32K PET. Send detail with price required to CLASSIC SERVICES, 4a West Parade, Lincoln.

PET 8K old ROMS good condition £415. PET Toolkit £47. Hoddesdon 44640.

PET 2001-8K plus manuals plus instructional and games cassettes. £350 o.n.o. Home 01-761 0743. Office 01-580 4468 Ext 3271.

32K ITT2020, 16 channel 8 Bit A.D.C., Creed 75, £745. Mr McArdle, 0751 31751 office hours.

Pet 16K, New ROM, Large keyboard, Cassette deck, Strathclyde Basic Course, manuals, games etc, 6 months old £575 o.n.o. Tel: Abingdon 22877.

SDS

SDS 100. Single unit containing 32K memory (expandable to 46K); up to 8K PROM; twin double-sided floppy disc drives of 500 bytes each, serial and parallel RS232 interfacing; keyboard; 12in. video display; power supplies; SD monitor program; line printer available. CP/M, 8080 assembler, E Basic, Editor supplied with system; M Basic, Fortran and Cobol available for business use, industrial process monitoring and control (with additional hardware). All CP/M games and business packages. Sole supplier Airamco (0294 65530).

From £3,750

SEMEL

Semel I. Min size: 4K with CPU, keyboard and monitor. Max size: 64K with single floppy disc unit, printer, VDU and keyboard. Can be coupled to any external device and controls up to 8 x 250K floppy disc units. Four configurations available. Options: Light pen attachment; 12V DC power supply; remote terminals. Software: Editor, Assembler, debug, full file-handling capabilities in Basic, Fortran and Cobol available on 64K machine; user-defined programs written and compiled by agreement; word processing. General-purpose unit for use as a terminal controller. Suitable for small business and OEMs. Available from Semel exclusively (0822) 5439.

£1,950 with Basic

SEN ELECTRONICS

Organiser. Intel 8085, 64K RAM, multi-user basic, 8in. double-sided floppy discs or 20MB hard disc, three RS232C ports. SEL (09328) 66744.

From £7,500

SGS-ATES

Nanocomputer. Z-80, 4-64K RAM, Gamma bus, 2K NC-2 monitor in ROM, Basic as an option, RS232, cassette interface, Hex keyboard. Midwich (0279) 411226.

From £420

SHARP ELECTRONICS

MZ-80K. Single unit comprising keyboard, display and cassette, Z-80 Processor, 20K expandable to 48K, built-in music function, fast cassette — 1200 bps. Floppy discs and printer available soon. Basic from cassette, machine language tape, assembler available soon. Sharp Tel: 061 205 7321. 25 dealers.

From £520

SOLID STATE TECHNOLOGY INC.

Athena Dt/C 8200. Eight-bit 8085 desktop computer with in-built dual mini floppies, inbuilt dual mini-cassette, inbuilt matrix printer and 1920 display. Can be expanded with 10 micros, beyond the CPU, each working as an intelligent controller, up to four floppy disc drive and four rigid disc drives. Maximum memory is 1.2GBytes. Standard system software is the AMOS multi-task operating system. Claims a performance roughly comparable to the DEC PDP-11/34. Butel-Comco, Southampton (0703) 39890, are the sole U.K. distributors.

From £3,000

SORD

M100. Min size: 16K RAM; 4K ROM Monitor; full keyboard plus function keypad; two-channel joystick dual cassette I/F; 11K E Basic on cassette; video; graphics; printer; S100 bus; converters; speaker; 24-hour clock. Max size: 48K RAM, 8K ROM; black and white or colour graphics; mini-floppy discs. Suitable for OEMs, small business, education, laboratory and scientific and home computing. Main distributor is Dectrade, but for London and South contact Midas Computer Services (0903) 814523.

From £726

SYNERTEK

Sym 1. 6502 chip and keypad with memory available in 4K blocks up to 64K. Port expansion kit, TV interface card, RAM expansion kit, cassette and Teletype interfaces. Any Kim software, Basic interpreter, Assembler/Editor, American, meant to be the foundation system for every small business and hobbyist users. Available from Newbear (0635 49223).

From £160 plus VAT



TANDBERG DATA

TDV Series. Intel 8080A, 32-64K RAM, Tandberg/Intel standard bus, 4K basic disc system in ROM, multi-user extended Basic, CIS Cobol, Assembler, semi-graphics, one plus three 8in. floppy discs — 250K — disc cartridge — 2.5MB — 8 ports. Tandberg (0532) 35111.

From £5,000

TANDY CORP.

TRS-80. Min size: Level I 4K memory; video monitor; cassette; power supply. Max size: Level II 48K up to 350K on-line via floppy discs; line printer; tractor feed printer and quick printer; floppy disc system. Modern, telephone interface soon available. Basic; some business packages. Level I aimed at the hobbyist and education market and Level II at small business applications. Hundreds of dealers. (Reviewed November, 1978).

Level I — £385
Level II — from
£559-£4,700

TANGERINE COMPUTER SYSTEMS

Microtan 65. 6502, 1K-48K RAM, Tanbus, IEEE-488 interface available, 1K Tanbug in ROM, extended microsoft Basic, 64 × 64 Pixel graphics on-board, 5¼in. floppy discs, 32 I/O lines and three serial ports. TCS (0353) 3633.

From £69 for CPU

TEI

PT. 8080, 60K RAM, S-100 bus, CP/M, 5¼in. floppy discs to four 8in. floppy discs, three serial and three parallel ports, 15in. CRT. Abacus 01-580 8841.

From £3,218

TEXAS 99/4

CPU: 9900, 16-bit processor plus 256byte scratch pad RAM. Total combined memory capacity: 72Kbytes, Internal ROM: 30Kbytes each. RAM: 16Kbytes. Operating system, Basic, sound and colour graphics, software contained in ROM. Basic price £655 available from Texas Instruments, European Consumer Division. Tel: (0234) 67466.

From £655

TRANSAM COMPONENTS

L4.1. 1K monitor, 2K Basic in EPROM; full graphics capability; 128 character set; power supply; cabinet; 56-key keyboard. Expandable to 65K. Available from manufacturer (01-402 8137).

£286 kit with SKB

Triton. 8080, 32K RAM, CP/M, 1K TB10S in ROM, up to three 5¼in. or four 8in. drives, serial and parallel ports. Transam 01-402 8137.

From £296 for
single-board
version.

ULBRICH AUTOMATION

Powerhouse II. 16K or 32K RAM, Z-80 processor, RS232 interface; 5in. built-in VDU; full keyboard; built-in mini cassette; real-time clock. Software; programmable keyboard in 16K PROM; 2K monitor system; DOS; Extended Basic. Options: larger VDU; discs, 14K Basic, Tripoli interface; X-Y graphics; IEEE interface. Compatible with all computers and peripherals. Applications: file management, off-line data processing and assembling capabilities. Suitable for OEMs and expert users. Available exclusively from Powerhouse Microprocessors Ltd. (0442) 42002, which will also manufacture it next year.

From £1,200

VECTOR GRAPHIC

48KB RAM, Z-80 micro; 63K bytes, mini-discs are standard. Options: graphics. Monitor, MDOS, Basic; business packages from dealers. Several distributors.

£2,300

ZILOG

MCZ Series. Z-80, 60K standard RAM, RIO operating system — 3K ROM, 12K RAM — Cobol, Fortran, Basic, Pascal, PLZ, graphics, 8in. and hard discs, RS232, up to 64K I/O, Memec (084421) 5471.

From £4,200

PET 8K Computer £340.00. EXPANDER PET converts an 8K Pet into a 32K, easy fitting £295.00. Telex High Speed CASSETTE COPIER £695.00. CASSETTE LABELLING MACHINE £130.00. Tel. 01-953 6921.

Commodore Pet 2001-32K, Anadex DP8000 Printer Plus accounting programmes and stationery. Equal New. Surplus requirements. £1,000. Mr Jonas: 01-253 3737.

NASCOM 1 complete with power supply mounted in Veroframe, Keyboard Case, Motherboard and 10 cassettes. Can be seen working. £180. T.V monitor £50. Tel. Harrogate (0423) 888614.

EXIDY SORCERER — 16K, £395 ono. Reading 479067.

PET 2001 — 32K, Cassette deck and cover. Seldom used. £625.00. Phone Stockbridge (Hants) Home — 832, Office — 766 or 824.

BORIS Chess Computer £99; Programmable calculators, Offers? HP 67, HP 97, Texas TI59 and Printer. Tel. Redhill 68126 (Office) John Doe.

32K PET, Big keyboard, New ROMs, immaculate, as new + cassette. £695.00 o.n.o. Bob Marshall 01-659 4748 after 7.00 p.m.

IBM Selectric golf ball printers with Aculab centronics interface. Gives word processing capability to Apple, ITT 2020, TRS 80, etc. Only £510 + VAT. Modus Systems, 29A Eastcheap, Letchworth, Herts. Tel. 04626 74468.

Micropolis Mod II 630K Dual Disk System, Type 1053 with S100 Controller — change to 16 bits forces sale — cost £1200 + VAT., sell £850 + VAT. (no offers). System Software Disks costing over £600 available to purchaser for nominal sum. Also surplus Heath H14 printer, professionally built, sensible offers invited. Tel. 0670 827480 (days) / 733125 (evenings).

Almost a hand-held computer. The TI-59 programmable calculator Only £95.

COMPUKIT UK101. Assembled with case, switchable 1/2 MHz £270. Mike — 01-534 5331. London E7.

Pet 2001 — 8K for sale, including manuals, cassette tapes, Microchess programme, TIS workbooks. £375 ono. Tel. Ramsey (Cams) 830004. Evenings.

HAZELTINE H-2000 VDU. 27 × 74 display, RS232 I/O, ports for printer and cassette drive. In excellent condition £300. Phone 01-888 7841.

For Sale. Complete development system comprising 32K EXIDY Sorcerer 12" Professional Monitor, S-100 Bus, 630K Micropolis disks and software, Wordprocessing ROMPAC, CPM, C-BASIC, ZSID Symbolic Debugger, MAC Assembler, Diskettes and all manuals. Sargon chess program available. List price £3,200 including VAT. Offers to Crawford, 061-928 8507.

Experienced Microsystems Engineer seeks spare time employment by new micro users. I will solve all your software and hardware problems for your business application. Ring Garston (Herts) 79973 Evenings and Weekends.

TRS80 Microcomputer for hire with word-processor facility. Introductory tuition given if required. 72 Regent Square, London E3 3HN.

KIT BUILDERS. Consult the professionals. Don't give up because it doesn't work. Help could be on its way. Contact Byrd Associates on Bedford (0234) 215826 or reply to Box No. PC4.

Centronics 779 printer in perfect condition £500 o.n.o. James McCosh, Kings Langley 624 69.

Volker-Craig boosts its production to meet delivery requirements!

To satisfy increasing demand for the VC 400 Series Data Terminals, Volker-Craig will manufacture over 12,000 units in 1980. And best news of all, 70% of these are destined for European markets to help you meet your delivery requirements.

Any of the 400 Series terminals, featuring detachable keyboard and non-glare screen, can be ordered today from your local distributor:

- VC404** A cost effective, reliable, ASCII teletype compatible terminal.
- VC414H** It's smart and Hazeltine 1510 compatible. Standard features include buffered editing, formatting and character highlighting.
- VC415APL** Offers full overstrike, split screen and buffered line edit mode.
- VC4152** DEC VT52 compatible featuring character highlighting, function keys and status line.

Foreign character sets, serial and parallel peripheral interfaces, and coloured display screens are just a few of the numerous options available on all models.

VC404. The *Standard* 1920 character, upper/lower case conversational terminal.



volker-craig limited

266 Marsland Drive, Waterloo, Ontario N2J 3Z1 Canada
☎ (519) 884-9300, Telex: 069-55327
Toronto: ☎ (416) 456-2070

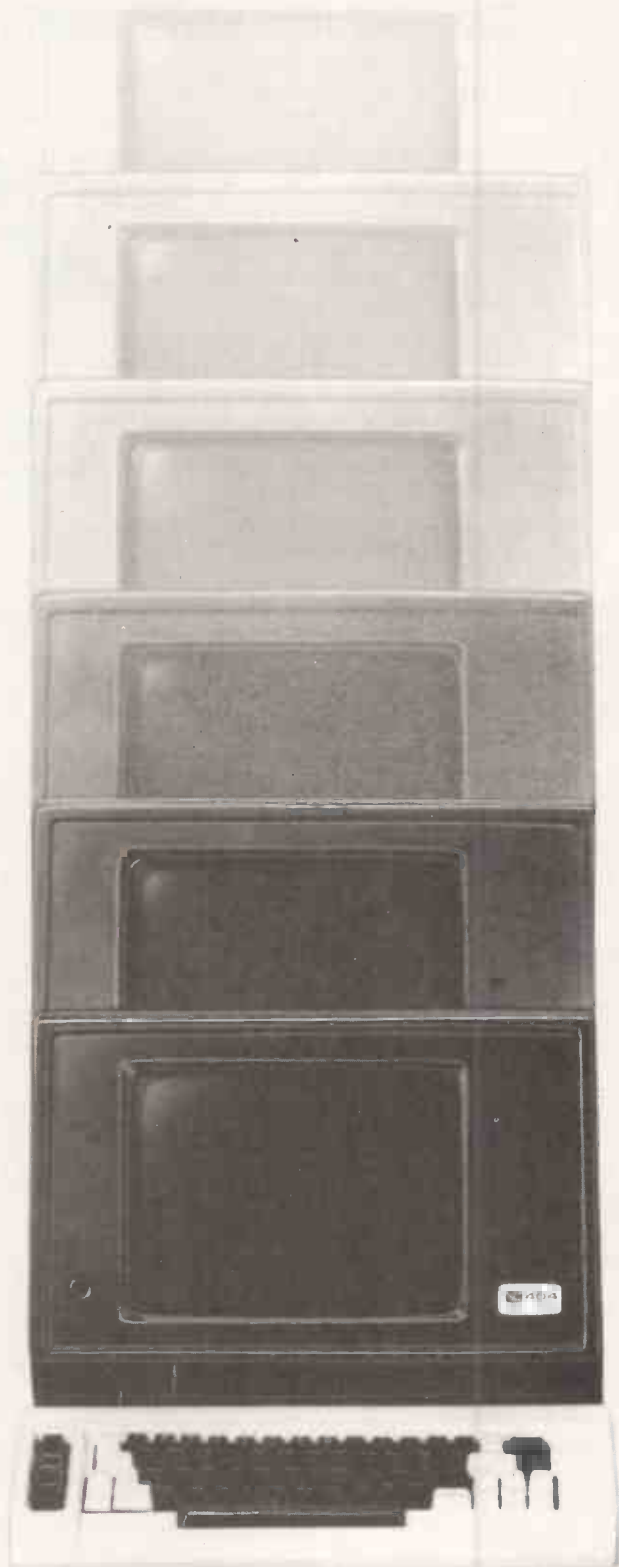

Distributors: Belgium, Cable Print nv, 53-704615; Canada, Ahearn and Soper Ltd., 416-245-4848; Denmark, A-S Danbridge, 95-55-22; England, Harwoods Business Systems, 0923-27257/8; Finland, Havulinna Oy, 755-4144; France, Eurotechnica S.A., 739-33-90; Germany, Deutsche Eurotech GmbH, 501108; Greece, Formore Ltd., 21-3093; Ireland, Cole Electronics Limited, 680-986; Italy, ESE srl Electronic Systems, 600 733 - 600 973; Norway, Morgenstjerne & Co. A/S, 37-29-40; Sweden, Dextraferm ab, 44-03-50; Switzerland, Erni & Co. Electro-Industrie, 833-33-33; The Netherlands, INCAA, 055-251 262; Australia, Anderson Digital Equipment Pty. Ltd., 543-2077; Israel, Contel, Control & Instrumentation Engineering Ltd., 260186; Japan, Ai Electronics Corp., 758-8161; Korea, Korea Computer Centre Inc., 792-7791-4; Mexico, Transdata, S.A., 399-98-00; New Zealand, IDL International Data, 797-691; Venezuela, Astron Electronica C.A., 781-1771

• Circle No. 232

PRACTICAL COMPUTING July 1980

We are now entering our fourth financial year of dealing solely in the personal computer market — in fact, we started it! Over this period, Personal Computers Limited have formed a group of graduate specialists who will help you in the fields of word processing, financial planning, statistics, economic modelling, forecasting, accounting systems, foreign exchange, banking and oil exploration. We also do rather well with computer graphics and highly recommend the graphics tablets and our plotter for Apple.

We can also offer two excellent items of software — **Format 40** and **Visicalc** — at a combined price of **ONLY £189**, and the **Super Sound Generator** for only **£90!** (excl. V.A.T.)



8" Disk Drive (above left)

Our 8" disks are still as popular as ever — 2 drives give you 1.2MB with all the reliable security of Shugart Technology. Easily interfaced to Apple, uses the same D.O.S.

A.I.O. Serial and Parallel Card (above centre)

Three hand-shake lines (R.T.S., C.T.S. and D.C.D.). Firmware for serial interfaces on-board, software for parallel printer available, 2 bi-directional 8 bit parallel ports, plus 4 additional interrupt and hand-shaking lines.

Light Pen (above right)

A much sought after product which we introduced to the U.K.

80 Character Card (below left)

... opens up the real commercial world for all Apple owners.

Paper Tiger (Below centre)

132 character line, plus graphics, 8 character sizes, ordinary paper, multiple copy, upper and lower case 96 character, parallel/serial, form control.

Centronics 730 (Below right)

A substantial, robust printer from a major manufacturer. 3 way paper handling system, 100 character per second. Special low-cost including interface. 96 characters.



Items pictured

Sharp MZ — 80K

A new generation of personal computer, self contained, versatile and starting at only £570 (excl. VAT). Explore the Zilog Z80 now the easy way. Disks and printer available shortly.

Numeric Keypad

... with 8 function keys is a must in all financial applications.

TCM 100 & TCM 200

... both now have graphics as well as their own power supply, essential with this type of printer.

Qume Sprint 5

The quality word processing printer. Clean, clear executive reports the way you want them. Can print up to 5760 points per square inch — or even print in 2 colours.

This is what we do..

and we do it rather well!



Personal Computers Limited

194-200 Bishopsgate, London EC2M 4NR Tel 01 626 8121

For further information, please complete this coupon and post to:-
 Personal Computers Limited, 194-200 Bishopsgate, London EC2M 4NR.
 NAME _____
 ADDRESS _____
 SPECIAL INTEREST _____

141

PC7

MICROTAN 65

- A 6502 based microcomputer
- Expansion boards to make a full system
- VDU alphanumeric display on an un-modified domestic TV
- 1K RAM for user programme, stack and display memory
- Superb 1K monitor TANBUG
- Fully socketed
- 136 page software/hardware users manual with example programmes and A4 size!
- Intelligent keyboard socket accepts 20 key keypad or full ASCII board
- Optional lower case pack
- Optional chunky graphics pack

TANEX

- 7K RAM, 6K ROM
- 8K Microsoft basic in ROM
- 32 Parallel I/O lines
- 2 TTL serial I/O ports
- RS 232C 20mA loop with programmable baud rates
- Four 16 bit counter timers
- Cassette Recorder Interface
- Memory Mapping Control
- Full complement of IC sockets
- Data Bus Buffering

TANRAM

- 7K Static RAM
- 32K Dynamic RAM
- Onboard refresh totally transparent to cpu operation
- Fully expands available address space of the 6502 microprocessor



Practical Computing Back Issues

Each month, *Practical Computing* carries at least one hands-on test of a popular microcomputer for use in business, the home, schools and colleges. Each issue contains the kind of information you need — technical data and for the intelligent professional layman, unbiased critical comment on the strengths and weaknesses of each system or service reviewed.

All this makes *Practical Computing* an invaluable source of whys, wherefores, hows, ifs and buts of microcomputing.

Order your back issues now, by simply filling in our Back Numbers order form bound in every issue.

October 1978 *
Review 1: Commodore Pet I **Review 2:** VDUs — Computer Workshop Ct-64, Strumech Engineering ACT-1, Music on a KIM; Micro v Calculator; VAT accounting complete program Part 1.

November 1978 *
Review: Tandy TRS-80. Projects for KIM: Pet goes to school; VAT accounting complete program Part 2; Complete game program — Mastermind; Software Dynamics Basic compiler review.

December 1978 *
Review: Research Machines 380Z. Choosing your first computer; ITT Interview; Complete games programs — Battleships, Racing Cars and Monsters; A microcomputerised reservation system.

January 1979
Review: Nascom I Convert an IBM typewriter into a terminal Part 1; In-car computing — Pet in the Panther DeVille; Report from the Los Angeles Computer Faire; Pascal v Basic

February 1979
Reviews: Cromemco Z-2D. Low-cost peripherals. Systems for estate agents and doctors; A £1000 payroll system; IBM typewriter conversion Part 2; Complete game program — Warlock Warren.

March 1979
Review: Single-board computers for less than £50 Low-cost stock-control systems; IBM typewriter conversion Part 3; New monthly column — Tandy Forum; Complete game program — NIM.

April 1979 *
Review: North Star Horizon Business accounting systems; Apple II design story Part 1; Computerised school meals; Finance for school computing; Build your own frequency meter; Star Trek game.

May 1979
Reviews: Eady Sorcerer, Science of Cambridge Mk 14; Printers for less than £1000; Order processing/invoicing packages; Retire with your computer; Apple II design story Part 2; Sialom game.

June 1979
Reviews: CompuColor II, Ohio Superboard II; Low-cost word-processing; Computing in a pharmacy; Designing a small business application Part 1; Computer v. Brain; Zombie game.

July 1979 *
Reviews: AIM-65, SOL-20. Choosing your first computer; Interfacing Pet with a mainframe; Nascom story; Designing a small business application Part 2; Biorhythms program.

August 1979
Reviews: Pet II KIM, Pros and Cost of PASCAL Microcomputer user groups. Designing a small business application Part 3; Interfacing Pet with a mainframe Part 2; Life game program.



September 1979
Reviews: Powerhouse 2, Apple Anadex and Heathkit printers; Apple II printer; Build your own keyboard; The scene in the North West; What's in store for a Pet; Self-teaching games program

October 1979
Reviews: Disc systems for Apple II and Tandy; Build an audio scoreboard; Inside Speak & Spell; Introduction to LISP; Inside Prestel.

November 1979
Reviews: Fair Black Box; MCS Teletext computer; Computer for radio amateur; Learning program for the self-testing chip; Financial modeling.

December 1979 *
Reviews: Transam Triton, Eurapple and ITT 2020. Corvus hard disc for Apple II. How to set up computer studies in schools. Tips for Sorcerer users. File handling techniques.

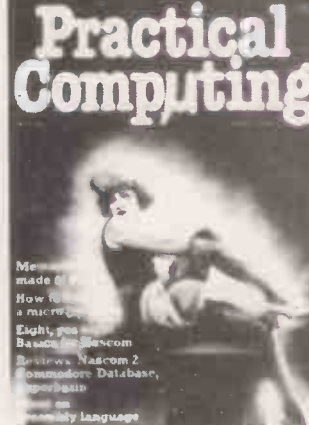

January 1980
Reviews: Hewlett Packard HP4/C, TEL systems. Eurapple — What's in store for 1980. Computer graphics. Using a micro to measure pain responses. Getting started with micros.

February 1980 *
Reviews: Minimax. Add-on machine code chip for Pet. Video Genie; Personal computer networks; Multi computer electronics and miniaturisation; Blake 7, a simulated battle game; Model building for education; Robotics Part 1; Commodore printer; Micro in antique business; How to write better programs; High speed stepper motors and the Pet.

March 1980 *
Reviews: Tandy TRS-80 model II. MSI System 7; Training schemes for programmers; Copyright Law and software; Computer-date program; Sheepdog trial, game for Pet; Robotics Part 2; The Games master, three page celebration of games playing; Assembly language series part 1, machine code; Hardware Buyers' Guide.

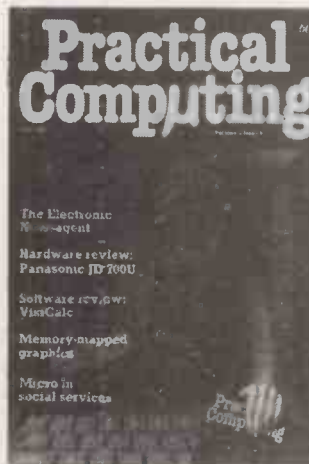

April 1980
Reviews: Nascom single-board, Superbrain. Commodore database; Viewdata are made to this, latest techniques; Storage; How to raise cash for your micro business; Eight Basics for Nascom; LA video link for London; Software Buyers' Guide.

May 1980 *
Reviews: Z-Plus UK-101; Intelligent gambling, how the micro might forecast sports results; Videotex and the micro; Why good software is expensive; Cobol; Assembly language part 3; New monthly column — 6502 Special. COS for Apple II. Hardware Buyers' Guide.

June 1980
Reviews: Panasonic ID-700U, VisiCalc. The electronic newsagent, newstrade applications; Latest developments in viewdata systems; Social services and micro applications; Electric motors as computer-controlled servo mechanisms; New monthly column — Sorcerer's Apprentice; COS for Apple II part 2. Software Buyers' Guide.

* Limited Stocks

Fill in the coupon opposite and return it with your remittance to *Practical Computing*, General Sales Dept, Room CP34, Dorset House, Stamford Street, London SE1 9LU. Please note that back issues can be ordered only on the current order form.

The Software Solution

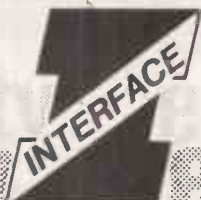

We all know that a computer system is only as good as the software and that much of the applications software hitherto available has proved to be the weak link. Written in Microsoft basic for use with CP/M based hardware, Interface Software is probably the most comprehensive and robust application software currently available, which really will transform your micro-computer into an effective problem solving tool.

Applications Software

- Nominal Ledger
- Sales Ledger
- Purchase Ledger
- Payroll
- Incomplete Records
- Word Processing (Wordstar)
- Mailing Address
- Etc.,

Systems Software

- CP/M
- MP/M
- MBasic 5.0 (CP/M) Interpreter/Compiler
- CBasic (II) Interpreter/Compiler
- Fortran 80 Compiler
- Cobol 80 Interpreter/Compiler
- Pascal 8 (UCDS) Interpreter
- Z80 Macro Assembler

Recommended by Logitek for the ALTOS microcomputer and Rostronics for the Micromation but of course suitable for any CP/M based machine.

For more details contact Jim Reid or Sue Archer at:-

DEALER ENQUIRIES WELCOME.



INTERFACE SOFTWARE LIMITED,
100, PARK STREET,
CAMBERLEY,
SURREY.
Telephone (0276) 27982.

• Circle No. 235

XITAN SYSTEMS

CROMEMCO SYSTEM 3

£4,054.00 for this system with vdu.

The ideal business system. System includes a full 64K fast RAM, dual full-size floppies (Persci 277), RS232 interface/20mamp loop for console device, parallel printer port (Centronics/Anadex compatible), 21 slots for expansion, Lear Siesler 24 lines or 80 chars vdu, and CROMEMCO's CDOS operating system with their 14 digit BCD extended disk Basic — ideal for those accurate large numbers required by successful businesses. CDOS is CP/M functionally equivalent, with many extra facilities. Optional extras from Xitan include Fortran, Cobol, Text Formatting, Z-80 macro-relocating assembler and DBMS at £59.00 each, CIS interactive screen handling Cobol at £425.00 (recommended to serious business users), Cromemco S100 boards, CP/M (we are an authorised oem distributor of Digital Research's CP/M) for the System 3, Wordmaster, Wordstar, Supersort, and CPM374X utilities.

ON DEMO NOW! THE CROMEMCO Z2-H

For only £4,995.00 set the reliability and quality of Cromemco, coupled with the capacity of the new IMI 11 megabyte hard disk drive. This is incredible value for money. Specification includes transfer rates of up to 10 times faster than the fastest standard floppy disk, DMA controller for up to 7 hard disk units, and the new extended CDOS operating system. Systems available in three configurations:— A) The Z2-H complete integral system, 64K RAM, Z80A cpu, two double-sided mini-floppies, RS232 console port, parallel printer port, power supplies, cables, case and 12-slot S100 motherboard (7 slots free). B) Additional hard disk subsystem for existing system 2 or system 3 users consisting of one hard disk, DMA controller, power supply, case and cable. C) As unit B but with two hard disks. Prices: Unit A) £5,380.00.
B) £4,330.00.
C) £7,420.00.

COMING SOON! ... Full 7-terminal multi-user operating system from Cromemco for System 3 users. Up to 48K per user, all running independently. This operating system has to be seen to be believed. It will run any of the Cromemco provided and supported software packages, in any combination. Features include partition rescue facilities, allocating more memory to users, real-time clock for time/date stamping of jobs and disk queueing techniques. Buy your System 3 now, expand later as you need it.

Xitan Systems also supplies and stocks vdus, printers, NORTH STAR HORIZON computers, Commodore Business Machines PETs, S100 boards, and books. We are here to demonstrate the range of quality microcomputer systems available for use today. Ring up for an appointment now! You'll not be disappointed. We have Osborne's Sales Ledger and Payable Ledger in source form for use on Cromemco System 3 with CBASIC2, and we can offer a customising service on these programs. Additional software includes Microsoft Basic Interpreter and Compilers, Cbasic, Macro80, and CP/M for the North Star Horizon.

Xitan Systems Ltd., 23 Cumberland Place, Southampton SO1 2BB.

Tel: (0703) 38740

Hours Tue-Sat 9.30 am to 5.30 pm

• Circle No. 236

the electronic office

You may think that there has already been a revolution in the office — starting with typewriters and telephones, going on to calculators, copiers, telex and facsimile machines, culminating in today's business computers and word processors. But all that is only a taste of what is to come.

now Rostronics introduces system Z

A state of the Art Microcomputer System. The first Multi-user Microcomputer to employ separate memory and CPU for each user. Each work station programs at 4Mhz speed as fast as the fastest standalone Z 80 System. The modular design means you can upgrade the single user Z Plus Microcomputer adding hard disk and additional users as required. System Z employs an advanced Multi-user CP/M network. This means that CP/M based languages and applications will execute on System Z unmodified.



ROSTRONICS

LIMITED

The Z System is marketed throughout the U.K. & Europe and is available through a number of selected dealers.

115-117 WANDSWORTH HIGH STREET, LONDON SW18 4HY
Telephone: 01-874 1171 Telex: 8813089 INTPRM G

DILLONS

UNIVERSITY BOOKSHOP
1 MALET STREET, LONDON WC1E 7JB
Telephone 01-636-1577

For all your books on Computer Sciences see us on **Stand 20** at the **Microcomputer Show 1980**, Wembley Conference Centre between 22nd-24th July.



The shop has now expanded to include larger Geography, Education and History departments with the Science subjects occupying the whole of the enlarged basement floor. In addition, Dillon's stocks Secondhand and Antiquarian books and our Record department carries a wide range of records and cassettes of the best in classical and spoken word recordings.

This large and varied stock enables us to provide a comprehensive service to both personal and mail order customers alike.

A Pentos Company

• Circle No. 238

MINSTER MICRO SYSTEMS

FOR APPLE & MICROSTAR COMPUTERS
We are MAPCON consultants and can solve your software problems.

APPLE II

Payroll
Stock Recording
Order Processing
Sales Ledger
Purchase Ledger
INTERFACES
16 Chan. AtoD
Relay Switching
D to A

MICROSTAR

Payroll
Sales Ledger
Invoicing
Purchase Ledger
General Ledger
Stock Control
Job Costing
Word Processing

Special packages
written to order

**MINSTER MICRO
SYSTEM LIMITED,**
88 CHRISTCHURCH RD,
RINGWOOD,
HANTS.
TEL: (04254) 4751



• Circle No. 239

CREAMWOOD SOFTWARE PRODUCTS LTD.

CREAMWOOD
CREAMWOOD
CREAMWOOD
CREAMWOOD The Professional
Software House.
CREAMWOOD Specialise in bespoke
BUSINESS programs for
PET, APPLE, and ITT 2020
Computers.
CREAMWOOD offer Competitive Quotes
including
FULL WRITTEN FEASIBILITY REPORTS.
CREAMWOOD for on site training and
CREAMWOOD COMPREHENSIVE
BACK UP.
CREAMWOOD
CREAMWOOD
CREAMWOOD
380, STATION ROAD, HARROW, MIDDLESEX.
01-963 0833.
TUESDAY - SATURDAY 10AM - 6PM.
FOR COMPLETE SOFTWARE SATISFACTION
CREAMWOOD SOFTWARE PRODUCTS LTD.

• Circle No. 240

NEW LOW COST PRINTERS

New performance standards in a dot matrix printer for under £500



The Microline 80 offers unmatched flexibility and power for a dot matrix printer of this size, with low power consumption and low noise. The printer is of simple mechanical construction and runs without routine maintenance. The unique print head lifetime is rated to 200 million characters and can be replaced by the user. Standard half inch nylon ribbons and standard roll or fan fold paper contribute to the low operational cost of the Microline 80. Pin and friction paper feed is standard,

with tractor feed optional. The Microline 80 offers as standard a variety of special print features such as character spacing of 5, 10 or 16.5 characters per inch with 40, 80 or 132 print columns and line spacing of 6 or 8 lines per inch, all software selectable. The 16.5 characters per inch spacing allows printing of 132 columns on 210 mm wide paper. The Microline 80 has a parallel, Centronics compatible interface, and a serial RS232 interface is optional.

- **Small size: 342W x 254D x 108H mm**
- **Light weight: 6.5 kg**
- **160 characters, 96 ASCII and 64 Graphics**
- **3 character sizes: 40, 80 or 132 characters per line**
- **No routine maintenance**
- **80 characters per second**
- **9 x 7 matrix**

X-Data Ltd, Marish Wharf, St Mary's Road, Langley, Slough, Berks SL4 1HE. Tel: Slough 49117 Telex: 847728

X-DATA

Equipment Wholesalers



KRAM KEYED RANDOM ACCESS METHOD

Now available in the UK!

KRAM is quite simply a revolution in microcomputer disk access techniques, and another FIRST for the PET! Just plug the KRAM ROM into your 16K/32K PET, load the rest of KRAM's machine language logic from disk (just like DOS), and with the ten commands illustrated below you have complete control of your disk data, either directly by Individual key, or sequentially in forward or reverse ASCII order. KRAM is a development of "VSAM" mainframe techniques. KRAM is fast, compact, and does not interfere with BASIC. You'll wonder how you managed without it! Get cracking - get KRAM!

CREATE KCS="CREATE O:MAILFILE,120,15,1: SYS 24600 This example tells KRAM to create an indexed file called MAILFILE on the disk in drive zero, with a record length of 120 characters and a key length of 20 characters which starts at position 1 of the record. KRAM looks at the RESERVED variable KCS to identify the function and its parameters; the SYS call tells KRAM to execute the function. The record length can be any value up to 254 characters and the key up to 48 characters, a total of 302. KRAM packs as many records into the 255 character disk block as necessary.

OPEN KCS="OPEN O:MAILFILE": SYS 24579 This tells KRAM that we will want to make accesses to the file called MAILFILE on the disk in drive zero. KRAM returns in location zero (peek (0)) the file number by which this file can be accessed during the rest of the program.

ADD KCS="ADD 1,NAS,ADS": SYS 24591 This tells KRAM to add to file number one the data in variable ADS whose key is NAS. For example in a mailing list, the key NAS might be the name 'SMITH A.J.' and ADS might be the address '120, HIGH STREET, ANYTOWN'. Any normal double character string variable can be used to denote the key and the record.

GET KCS="GET 1,NAS,ADS": SYS 24582 This tells KRAM to get from file number one the data belonging to the key NAS and put it into variable ADS. In our example, if NAS was 'SMITH A. J.', KRAM would read the address '120, HIGH STREET, ANYTOWN' from file and put it into variable ADS. If we weren't sure of the exact surname, we could give KRAM the key 'SM' and it would get for us the next alphabetically higher name beginning 'SM', together with its address! Or if we gave KRAM a blank key, it would find the first name and address on file.

READ KCS="READ 1,NAS,ADS": SYS 24585 This tells KRAM to read the data belonging to the next highest key following the name in NAS, and put it into variable ADS. In our example, a complete file of names and addresses could be read in alphabetical order, starting at any name in the file, simply by executing successive READ commands! For instance, having got Mr A. J. Smith from file, executing the READ command as above would get us say 'SMITH M.' in NAS together with his address in ADS.

READ - KCS="READ-1,NAS,ADS": SYS 24585 This works like READ except BACKWARDS! It tells KRAM to read the data belonging to the next lowest key preceding the name in NAS, and put it into ADS. For instance, having read 'SMITH M.' with the forward read, executing the backward read as above would get us 'SMITH A.J.' in NAS together with his address in ADS.

PUT KCS="PUT 1,NAS,ADS": SYS 24588 This tells KRAM to rewrite to file number one the data in variable ADS which belongs to key NAS. For instance, if we wanted to change Mr A.J. Smith's address, we would simply set NAS equal to 'SMITH A.J.', ADS equal to his new address, and execute the PUT function.

DELETE KCS="DELETE 1,NAS,ADS": SYS 24594 This tells KRAM to delete from file number one the key contained in NAS and its associated data contained in ADS. In our example, to delete Mr A. J. Smith from the file, we would simply set NAS equal to 'SMITH A.J.', ADS equal to his address, and execute the DELETE function. KRAM will release for further use the disk space made available by the deletion.

CLOSE KCS="CLOSE 1": SYS 24597 This tells KRAM that file one is finished with for now. KRAM updates the BAM on disk, but the file can still be used without another OPEN command.

INITIALIZE SYS 24600 This function is used at the beginning of each program to clear KRAM's work areas and buffers.

The examples above illustrate the use of KRAM in a mailing list application, with disk access times from less than one second. KRAM can of course be used in any application program with the Commodore disk where programmer time, user time and disk space are at a premium.

Each KRAM package includes a ROM which plugs into the middle ROM socket of the 16K/32K Pet, a demonstration disk with a mailing list program and a 40-page User Reference Manual. KRAM is available by post (cash with order) price £115 including VAT, or by credit card phone the KRAM 24 Hour Order Desk on 01-546 7256; or see your nearest dealer. (Quantity discounts available).

Calco Software

Lakeside House, Kingston Hill, Surrey KT2 7QT 01-546-7256

Mainframe software at a micro price

• Circle No. 242

A.M. TASK FORCE LTD.

Computer Career Professionals.
Register yourself on our micro-computer
for a new permanent job or contract in U.K.,
Europe or U.S.A.



All levels of staff required. We provide advice
and assistance to contractors and career
guidance to permanent candidates.

2C Southchurch Rd.,
Southend-On-Sea,
Essex
0702-615551

44 Kingsway,
Stoke-on-Trent,
Staffs.
0782-410217

Talk to John or Tony | Talk to Chris or Derek

OUR REPUTATION TELLS ALL

• Circle No. 243

Main London Sorcerer Stockists EMG 01-688 0088

We are specialists in complete installations
tailor made for your business requirements:

WORD PROCESSING SYSTEM	£1999
ESTATE AGENT SYSTEM	£2999
LEADS AND SALES SYSTEM	£2999
INSURANCE AGENT SYSTEM	£2999
AGENCY SYSTEM	£2999
COMPLETE BUSINESS SYSTEM	£3999

For the Sorcerer Specialist:

- Sorcerer Systems Desk
- Mains Stabilisation
- Cooling Fan
- Memory Upgrades
- Servicing Undertaken
- WP Correspondence Course
- Link your Sorcerer to another Sorcerer
- Link your Sorcerer to a Main Frame
- Full software list on request

6 COPIES OF SOURCE MAGAZINE ONLY £5

Write to Dept PC6, EMG Microcomputers Ltd,
30 Heathfield Road, Croydon, Surrey.

• Circle No. 244

PETAID

EVERY PET SHOULD HAVE ONE!



SPECIAL OFFER JULY & AUGUST

From 15th July - 31st August.

ALL Stage One Software Products can be purchased DIRECT from Stage One Software at list price LESS 25% + VAT.

Please send C.W.O. payable to Stage One Software.

LAST DATE: 31st AUGUST

NO orders processed after that date.

Stage One Software, 6 Criterion Arcade,

Old Christchurch Road, BOURNEMOUTH, Dorset.

Tel: 0202 23570 or 295395

PETAID EVERY PET SHOULD HAVE ONE!

PURPOSE: Provides the complete basic structure for file and screen creation and subsequent insert, Amend, Delete, Display, Search and Print.

BENEFITS: Simple commands, no need for programming knowledge. Create your own screen and file layouts. Files up in hours. Highly structured in Basic. Simple appendment of further basic code for maths and specialised prints, well documented to allow the user to modify the program. Standard variables used, can halve the time for systems development. Common structure for ease of subsequent support. A very powerful STAND ALONE file create and retrieval system. The create file program can be used many times for various files. Further compatible utilities to be available.

VERSIONS AVAILABLE: Tape Files £52.95, Sequential Disk £150.65, Random Access Commodore Disk and Computhink 400K £208.15, Computhink BOOK £231.15, Indexed Access Method Commodore Disk (Alpha Key Field) £288.65, Extract & Sort on Random Access or IAM Files £87.40.

All prices include V.A.T., Package and Postage.

PRINTERS SUPPORTED: Commodore, Anadex, Gume, Teletype 43.

FEATURES. The user may:

Define their own screen and file formats. Multiple disks per file. Very powerful search routine on any field and any content. Up to 50 separate search criteria or multiple simultaneous searches. Unlimited number of fields per record. PETAID programs within same Version are compatible with all PETAID created files of that version. Tape to Disk conversion utility as an extra.

PACKAGES: ALL PACKAGES REQUIRE: 32K PET, COMMODORE DISK & PRINTER

INCOMPLETE RECORD SYSTEM PETAID Based Provides user specified Account Numbers, Titles and Final Account formats. Common input for new or carry forward clients. Up to 2300 Nominal Account Numbers. Unlimited transactions.

Incomplete £862.50 Final Accounts £402.50

BANK & RECONCILIATION PETAID Based Bank Accounting System, automatic facility for standing orders and direct debits. Reminder for charges and interest. 2000 Transactions per Bank Account. £115

ESTATE AGENTS PACKAGE PETAID Based Property and Applicants registers for speedy selection of properties or Applicants. 325 Applicants or Properties per disk. £287.50

MAILING SYSTEM PETAID Based A complete Mailing Suite, labels, lists, multiple labels. Labels selective based on interest groups, etc. £115

BOND & PENSION CALCULATIONS Allows the Broker or Agent to use the PET as a selling AID to Demonstrate Bond & Pension and Insurance Quotations. £115

QUOTE PROCESSOR PETAID Based Word Processor in Basic with Mathematics for wordy and complex quotation production. 150 Paragraphs of 10 lines each with price field per line. £138

GENERAL ACCOUNTING PACKAGE PETAID Based Open item Sales, Purchase, Nominal, Rechargeable Costs, error and status checking (back up forced). One posting routine for all transactions. 4000 Accounts and 18400 live transactions. £680

OTHER PROGRAMS

STOCK £115. BLOCK COPY (Bad Blocks Omitted) £28.75. DIARY PLANNER £115. DOUBLE PRECISION MATHS (M/C Code) £57.50.

SOFTWARE SUPPORT SYSTEM

Stage One Software offers a special support and reporting system to enable the users of our Software to get the very best support and advice on how to gain maximum benefit from our packages. Enquiries

will be actioned promptly to provide a first class service which has so far been lacking in the Micro-computer industry.

Adda Computers
LONDON W5 2NH
Tel: 01 579 5845

Catlans Computers Ltd
CHESHIRE
Tel: 0625 527255

Metyclean Ltd
LONDON SW1E 5JL
Tel: 01 828 2511

Sheffield Computer Centre
SHEFFIELD
Tel: 0742 53519

R Ward & Son
GATESHEAD, Tyne & Wear
Tel: 0532 605815

Advanced Management Systems Ltd
LONDON EC2Y 9AA
Tel: 01 638 9319
01 606 4975

D A M's Office Equipment Ltd
LIVERPOOL
Tel: 051 227 3301

Microwave Computers Ltd
HULL HU4 6SB
Tel: 0482 5627107

Slough Microshop
SLOUGH
Tel: 0753 72470

Walters Computers Systems Ltd
STOURBRIDGE, W Midlands
Tel: 0582 885937

Alpha Business Systems
HERTFORD
Tel: 0992 57423

G M Marketing
ANDOVER, Hants
Tel: 026 471 410

Milequip Ltd
GLOUCESTERSHIRE
Tel: 059 451 624

Software Development Services Ltd
DUBLIN 4
Tel: Dublin 685755

Microputers Ltd
KENDAL, Cumbria
Tel: 098 62 4101

Amplicon Micro Systems Ltd
BRIGHTON
Tel: 0273 562613

J A D Integrated Services Ltd
PLYMOUTH
Tel: 0752 82618

MMS
BEDFORD
Tel: 0234 40602

Tekdata
STOKE ON TRENT STB 4PA
Tel: 0782 813831

T & V Johnson (Microcomputers)
CAMBERLEY, Surrey
Tel: 0276 62508

Business Electronics
SOUTHAMPTON
Tel: 0703 738248

Jeffrey Martin Computer Services Ltd
NEWQUAY
Tel: 063 73 2663

RPL Microsystems
DOUGLAS, I.O.M
Tel: 0624 4247

Thistle Computers
ORKNEY KW15 1HQ
Tel: 0856 3140

Melard Services (Fylde) Ltd
POULTON LE FYLDE, Lancs
Tel: 0253 823654

RUF Computers (UK) Ltd
BURGESS HILL, Sussex
Tel: 04448 45211

***SPECIAL OFFER*
JULY - AUGUST
SEE ABOVE**

MAIL ORDER Written orders with cheque or Access/Visa No. to:

STAGE ONE SOFTWARE 6 Criterion Arcade, Old Christchurch Road, Bournemouth, 23570



Buy it with Access

Please supply: ITEM QUANTITY

AMOUNT £ CHEQUE NO.

Name

Address ACCESS/VISA NO.

PC7

• Circle No. 245

S Software for TRS80®

ACCEL Compiler for TRS80 BASIC

Speeds execution of correct Level 2, BASIC programs by compiling the common statements to Z80 machine-code.

- Develop and debug normally.
- Compile for production work.

ACCEL (16K) Great value at.....£19.95

DLOAD	Load program segments.....	£4.95
ZBUG	Debug Z80 programs.....	£11.95
TSAVE	Prepare system tapes.....	£4.95
RENUM	Renummer BASIC programs.....	£5.95
FGRAF	Fast Graphics.....	£4.95
XREF	Program cross-reference.....	£5.95
SDUMP	Symbolic dump.....	£2.95
LIFE	(16K) 48 x 64.....	£3.00
USRN	Multiple USR calls.....	£2.95



Southern Software programs are self-relocating, load-anywhere, machine-code, well documented. They run in 4K Level 2, unless otherwise stated.

SOUTHERN SOFTWARE PO Box 39, Eastleigh, Hants. SO5 5WQ

• Circle No. 246

MICRO-FACILITIES

127 HIGH STREET
HAMPTON HILL
MIDDLESEX

01-979 4546
01-941 1197

MIDDLESEX & S.W.LONDON

Approved Business Dealers for:

Commodore Computers & Business Packages
Apple II
North Star Horizon
IMS 5000/8000 Series

As fully authorised Dealers for the above equipment, and as experienced data processing professionals, we are the best people to help you.

Our complete package offers you:

Free initial discussion & advice
Systems Design & Programming
Software Packages
Supply & Installation of equipment
Leasing & Financing terms
Full Maintenance Contracts
Genuine After Sales Service

Contact us to discuss your problems and requirements, we offer you a lot more, but only charge the same. Our ability will give you peace of mind and confidence that the job will be done properly.

• Circle No. 247

INTELLIGENT ARTEFACTS LTD

DISCOUNT PETS

8K PET WITH LARGE KEYBOARD £445
16K £535 32K £640

CASSETTE £54 DUAL FLOPPY £730
PRINTER £390 CABLES £25 OR £10

BASE 2 PRINTER 800ST £375

TRACTOR FEED; STEPPING MOTOR;
3 INTERFACES; 3 CHARACTER SETS;
FULLY PROGRAMMABLE

TEXAS TI 99/4 £569

THIRD GENERATION MICROCOMPUTER —
OPTIONS INCLUDE SPEECH SYNTHESIZER,
JOYSTICKS, ROMPAK SOFTWARE

EXPAND YOUR AIM 65

SEAWELL LITTLE BUFFERED MOTHER
WITH EXTRA 4K RAM £150
ALSO 16K RAM, PROTO-BOARDS ETC.
DISK SYSTEM COMING SOON
16K STATIC RAM £150

S-100 VOICE I/O - P.O.A.

TECHNICAL BACKUP FROM MAPCON
ENGINEERS. PRICES ARE EXCLUDING VAT

INTELLIGENT ARTEFACTS LTD

Cambridge Road, Orwell, Royston, Herts.
Telephone: Arrington 689

INTELLIGENT ARTEFACTS LTD

BUSINESS SYSTEMS

FOR SMALL COMPANIES
COMPLETE WITH SOFTWARE

£3300 + VAT COMPRISING:

NORTH STAR HORIZON, PRINTER,
VDU, READY TO GO
FULL LEDGER SOFTWARE WITH
PROFESSIONALLY TESTED MANAGEMENT
ACCOUNTING:
PAYROLL £55
ACCOUNTS PACKAGE £510
JOB COSTING £110

HARD DISK VERSION

WITH 18 MB WINCHESTER DISK

£6600 + VAT

SOFTWARE TAILORING SERVICE

INTELLIGENT ARTEFACTS LTD

Cambridge Road, Orwell, Royston, Herts.
Telephone: Arrington 689

• Circle No. 248

SUPERBRAIN™

There's been a lot of talk lately about intelligent terminals with small systems capability. And, it's always the same. The systems which make the grade in performance usually flunk the test in price. At least that was the case until the SuperBrain graduated with the highest PPR (Price/Performance Ratio) in the history of the industry.

SuperBrain users get exceptional performance for just a fraction of what they'd expect to pay. Standard system features include: two double density mini-floppies with 320K bytes of disk storage, 64K of RAM memory to handle even the most sophisticated programs, a CP/M Disk Operating System with a high powered text editor, assembler, debugger and a disk formatter. And, with SuperBrain's S-100 bus adaptor, you can add all the programming power you will ever need... even a 10 megabyte disk!



SuperBrain's CP/M operating system boasts an overwhelming amount of available software in BASIC, FORTRAN, COBOL, and APL. Whatever your application... General Ledger, Accounts Receivable, Payroll, Inventory or Word Processing... SuperBrain is tops in its class. But best of all, SuperBrain tackles your toughest jobs for less than one-third the cost of other similar systems.

You'll appreciate the careful attention given to every engineering detail. Standard SuperBrain features include: a full ASCII keyboard with numeric pad and user-programmable function keys. A non-glare, dynamically focused, 12-inch CRT for sharp images everywhere on the screen. Twin Z80 microprocessors to insure efficient data transfer to auxiliary peripheral devices. A universal RS-232 communications port for serial data transmission. And, a single board design to make servicing a snap!

Performance and packaging have never been better matched. Your operators will appreciate SuperBrain's good looks. You'll appreciate SuperBrain's outstanding value. Twin Z80A processors, dual double density disk drives, and a high resolution CRT terminal. All in a single, smart looking, self-contained desktop unit. And, all for a price that's substantially less than the competition!

Make no mistake about it. The freshman students in the small systems business can't begin to compete with this year's honor graduate. The SuperBrain. The only system at the top of its class in price and performance.

£1395

COMPLETE (+ VAT)

* OUR PRICE IS THE R.R.P.

K.G.M. MICROS LTD
88, HIGH STREET,
SLOUGH, BERKS.
TEL. SL. 38581

SUPERBRAIN™ is the registered trademark of Intertec Data Systems.

• Circle No. 249

Your key.

To MICROCOMPUTERS

This coupon will bring you details of our new complete home computer course.

You will learn all the basic principles of computer technology and receive full instruction on computer functions and programming. Tuition is carried out at your own pace on your own home computer and is supervised by our qualified computer staff.

FREE BROCHURES

Send today for a brochure on this exciting new course.

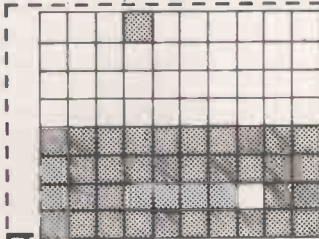

TUTORCOURSE HOME COMPUTER

Please rush me details of your HOME COMPUTER COURSE

Name

Address

Block Caps. Please

Post now, without obligation to:

British National Radio & Electronics School.

P.O.Box 156, Jersey, Channel Isles

PC7

• Circle No. 250

New low book prices

Also dealers for Acorn, Apple, Microstar and Alpha Micro.

BASIC & BASIC PROGRAMS

Running Wild: The Next Industrial Revolution Adam Osborne	£ 3.50
The Mighty Micro Chris Evans	£ 5.50
X1 Microprocessor Lexicon Sybex Inc.	£ 2.50
Microelectronics Scientific American	£ 4.00
Mind Appliance T G Lewis	£ 4.80
Introduction to Microcomputers Vol 0 - The Beginner's Book Adam Osborne	£ 5.40
Introduction to Microcomputers Volume 1 - Basic Concepts Adam Osborne	£ 5.90
Your Home Computer James White	£ 5.90
Peanut Butter & Jelly Guide to Computers Jerry Willis	£ 6.30
C201 Microprocessors: from Chips to Systems Rodnay Zaks	£ 6.90
Illustrating BASIC Donald Alcock	£ 2.30
Microcomputers in the Three R's: A Teacher's Guide Christine Doerr	£ 4.90
Little Book of BASIC Style: How to write a program you can read John Nevison	£ 5.40
Programming in BASIC for Business Bosworth/Nagel	£ 6.90
Basic Handbook David Lien	£11.00
BASIC and the Personal Computer Dwyer/Critchfield	£11.90
Computer Programs that Work! Lee/Beech/Lee	£ 3.00
Basic Computer Games David Ahl (Ed)	£ 5.50
More Computer Games David Ahl (Ed)	£ 5.50
Some Common BASIC Programs Poole/Borchers	£ 6.50
6502/6800/8080/Z80	
8080A/8085 Assembly Language Programming Lance Leventhal	£ 6.30
Z80 Assembly Language Programming Lance Leventhal	£ 6.90
Z80 Microcomputer Handbook William Barden	£ 6.90
Sargon: A Computer Chess Program Dan & Kathe Spracklen	£ 9.50



A COMPANY DEDICATED TO THE SERVICE AND SUPPORT OF TERMINAL AND MICRO BASED SYSTEMS

WE FIX MICROS

PETS, APPLES, SUPERBRAIN, ETC. AT £25 PER FIX (PLUS PARTS AND V.A.T.) AT OUR BELPER WORKSHOP

Contact: JOHN REES



NATIONWIDE SITE SERVICE

FOR DEC LS111 BASED SYSTEMS AND TERMINALS

Contact: BARRY DUKES



SPECIALIST TRANSPORTATION NETWORK

GETS THE GOODS WHERE YOU WANT THEM WHEN YOU WANT THEM - AT THE RIGHT PRICE

Contact: GORDON HADFIELD



A COMBINATION OF ALL THE ABOVE SERVICES OFFERS A COST EFFECTIVE COMPLETE SOLUTION

IF YOU HAVE MULTIPLE TERMINALS OR SYSTEMS OUR UNIQUE TRI-CALL COLLECTION CONTRACT OFFERS MAXIMUM DISCOUNT ON SERVICE COSTS

Details on request



TERMINAL SYSTEM SERVICES LIMITED

King Street, Belper, Derby DE5 1PW
Telephone: Belper (077 382) 7771 & 7772

• Circle No. 251



CompUtopia LIMITED

30 Lake Street, Leighton Buzzard, Bedfordshire
Tel: (0525) 376600 24 hour Answering Service

6800 Assembly Language Programming Lance Leventhal	£ 6.30
6502 Assembly Language Programming Lance Leventhal	£ 6.90
C202 Programming the 6502 Rodnay Zaks	£ 6.90
First Book of KIM Butterfield et al	£ 7.00
D302 6502 Applications Book Rodnay Zaks	£ 7.90
Programming a Microcomputer: 6502 Microprogram- ming MOS' KIM-1 Caxton C Foster	£ 7.90
Practical Introduction to Pascal Wilson/Addyman	£ 4.00
Pascal User Manual & Report Jensen/Wirth	£ 5.90
Introduction to Pascal Welsh/Elder	£ 7.00
Programming in Pascal Peter Grogono	£ 7.80
Microcomputer Problem Solving using Pascal Kenneth Bowles	£ 7.90
OTHER READING	
Cheap Video Cookbook Don Lacaster	£ 4.40
How to Build a Computer-Controlled Robot Tod Loofbourrow	£ 4.90
C207 Microprocessors' Interfacing Techniques Lesea/Zaks	£ 7.90
Computerisation: Layman's Guide for Directors & Senior Management E G Cluff	£ 4.90
How to Profit from your Personal Computer T G Lewis	£ 5.50
Vol 1 Fundamental Algorithms Donald Knuth	£10.50

Books will be despatched within 24 hours or our acknowledgment giving precise delivery date. All prices include p&p within the UK. Outside the UK please add 10%.

For details please contact 30 Lake Street, Leighton Buzzard. Tel: (0525) 376600. When ordering please state your cheque/postal order/Barclaycard number.

• Circle No. 252

software for

Payroll II

£375

Standard Hardware Requirements:

Apple II computer with Applesoft Basic and 48K memory.
Two Apple minifloppy disk drives or a 'Corvus' Hard Disk system.
132-column printer, connected to the Apple by a serial, parallel, or communications card.

PAYROLL II will hold comprehensive records for up to 200 employees on each minifloppy diskette or Corvus volume. The program will perform wages, Tax, National Insurance, and Pension calculations, and will print detailed payslips, summaries and departmental analyses for up to 185 employees at a time.

All Tax codes are supported.

All types of contracted-in and contracted-out National Insurance contributions are supported: NI schedules A, B, C, D, and E.

Automatic pension contributions on a flat-rate or percentage basis are allowed. Each employee may make contributions on a different basis if the employer so requires. The employer may also choose to make a pension contribution: this will be calculated automatically either as a lump sum per

employee, or as a percentage of each employee's wage.

The taxable wage for each employee may be assembled from the following components:

- a **basic wage**, calculated either as a lump sum (a salary) or, when the employee is paid on an hourly basis, as a number of hours multiplied by the employee's basic wage rate.
- Between one and four **overtime** payments, calculated as a number of hours multiplied by an hourly rate.
- Zero, one, or two **efficiency** payments, calculated on an hourly basis.
- Four **flat adjustments** for taxable lump-sum payments that vary from week to week or from month to month.
- One **standing adjustment** that is set as an item in each employee's record.

Adjustments to gross may include the following:

- pension contribution, calculated on a flat-rate or percentage basis.

- Tax, according to employee's Tax code.
- National Insurance, according to the employee's National Insurance letter.
- Three **standing adjustments**, each similar to the standing adjustment allowed before tax.
- Two **flat adjustments**, similar to those allowed before tax.

After all the figures for one week (or month) have been entered, payslips are printed in one batch. The system will then print the following:

- A summarised version of each payslip, plus the totals for the entire run.
- A coinage analysis.
- A wages analysis — the total wages paid by each method of payment: cash, cheque, and giro.
- A departmental breakdown of all payments.

When employees leave the firm, their records may be placed on *archive*. In this state, a record may be accessed and printed as normal, but payslips cannot be produced for the ex-employee.

The operator can instruct the program to print out the contents of any record, making easy the production of forms P45, P60, and P11(s).

The user may configure the system to suit the precise needs of his company. A function is provided whereby the operator may set the names of payslips items, record items, and department names. Unused system facilities and payslip items may be 'switched-off' to save the user time.

Holiday pay may be quickly and easily produced by a facility that allows the operator to 'overlay' any number of future weeks' or months' pay in to any employees' payslip. The program ensures that an employee cannot accidentally be paid twice in the same tax-period.

FOUR OVERTIME RATES		If employee is paid hourly, a line showing the number of hours worked at basic rate is printed instead		PENSION RATES: percentage here, but could be flat-rate		EMPLOYEE'S NAME NUMBER		EMPLOYER'S PENSION CONTRIBUTION printed only if made	
MURCATROYD MUSIC LTD		WEEK 1		1 APRIL 1980		HENNEN MISS C 3			
SALARY		232.88		ADJUSTMENTS TO GROSS:		NI EMPLOYER -22.61		TAX CODE D2	
15 0.00HRS 1.50		0.00		TAX (PAYE) 13		-114.10		PENS EMPLOYER 9.32	
15 0.00HRS 1.50		0.00		NI EMPLOYEE 14		-11.14		NI NUMBER W60312668	
15 0.00HRS 2.00		0.00		PENSION EMPLOYEE 15		-4.66		NI LETTER A	
15 0.00HRS 0.00		0.00		STANDING 1 16		0.00		METHOD OF PAYMENT: cash, cheque or giro	
5		0.00		STANDING 2 17		0.00		PAID BY CHECK	
FLAT ADJ 1 7		0.00		FLAT AFTER 1 19		0.00		BASIS OF WAGE: hourly, weekly or monthly	
FLAT ADJ 2 8		0.00		FLAT AFTER 2 20		0.00		BASIC WAGE RATE	
FLAT ADJ 3 9		0.00		TOTAL ADJUSTMENTS 21		-129.90			
FLAT ADJ 4 10		0.00		TOTAL GROSS 12		232.88			
STANDING 0 11		0.00		TOTAL NETT WAGE 22		142.98			
TOTAL GROSS		12 232.88		TOTAL NETT WAGE		22 142.98			

Fully Integrated Ledger System £855

Gives Management information, ie, aged accounts on individual clients, sales analyses, and trial balance. Profit and loss Balance sheet included.

Sales Ledger II only £315
Purchase Ledger II only £315
Nominal Ledger II only £225

Hardware Requirements:

Apple II computer with 48K memory and Applesoft in ROM. Two Apple Minifloppy Disk Drives, or one Corvus 10MB Hard Disk. 132-column printer with serial, communications, or parallel interface.

General Description

The standard ledger will handle up to 200 accounts with a total of 1000 transactions per floppy disk or CORVUS volume.

The package provides an interactive SALES, PURCHASE and NOMINAL ledger system on a brought-forward basis.

Both SALES and PURCHASE ledgers allow for the entry of INVOICES, PAYMENTS, ADJUSTMENTS (CR and DR), and CREDIT NOTES.

Nominal codes 1 to 70 may be used for posting to the NOMINAL ledger. However, codes 1 to 200 may be used for manual entries to the NOMINAL ledger.

Included in the NOMINAL files are a bank file, sales and purchase control files, and sales and purchase VAT files, all of which are automatically updated with the NOMINAL.

When exiting the SALES or PURCHASE ledgers, the option is given to update the NOMINAL ledger. The NOMINAL ledger updates from the most previously updated transaction; this means that, although daily ledger entries are made, the NOMINAL need only be updated, say, weekly.

Batch printout (with batch totals) of all, or of selected entries on the ledger is possible.

Reports obtainable are: statements, VAT summary with breakdown for up to five VAT codes, aged accounts, and individual account examinations.

Reports available from the NOMINAL ledger include trial balance and bank reports. Additional functions include PROFIT and LOSS, and BALANCE SHEET reports.

Invoicing £140

Either stand-alone — or can form part of our General Ledger System.

Cash Flow/Bank Forecast £80

Automatically updates all data following each alteration of an item. Gives column and line totals. Saves a lot of boring work when a Company operates with more than one bank account.

New Word Processing/Data Base £120

Release date: June

Screen-based editor, powerful global search editing facilities, formatting facilities, address data base facilities and possibility to join sections of text, old and new, for the final printout. FAST AND EASY TO USE.

The above programs work either on Apple II floppy system or a version for 10Mb Corvus hard disc drive is available.



Trade Enquiries Welcomed

Vlasak Electronics Ltd, Thames Building, Dedmere Road, Marlow, Bucks.

Tel: Marlow (S.T.D. code 06284) 74789

Telex 847008 Vlasak G



THE CLENLO CONQUERER



A Z-80 Microcomputer in an attractive Metal Cabinet, containing a 12 slot motherboard. Two serial and two parallel I/O ports are standard. Will accept a variety of S-100 compatible floppy and hard disc Drives.

16K RAM	650.00
32K RAM	805.00
48K RAM	960.00
64K RAM	1115.00

8" 500K Double Density Floppy Disc Drive and Controller.	700.00
Add On Unit	410.00

All prices exclude VAT

Clenlo Computing Systems



15 South View Court
The Woodlands
Beulah Hill
London S.E.19.
01-653 6028

• Circle No. 254

Dataplus make Apples sweeter

Apple – the most remarkable micro computer – now available from DATAPLUS LIMITED. Before considering any other for Educational – Commercial – Industrial or Scientific use, look at the Apple's specification. BASIC, PASCAL and now FORTRAN has been added to the list of operating systems. Where will it end? Make sure you purchase the Apple – this can be expanded bit by bit and does not become out-dated overnight.

Apple 11 plus

- Basic 16K machine...£695
- Disc Drive & Controller.....£349
- Extra Disc.....£299
- Pascal Language System.....£299
- Alf Music Synthesizer £180
- Graphics Tablet etc....£462
- all plus VAT



with the NEW
TX-80
dot matrix printer
only **£445** see below
+VAT



- The TX-80 is a Complete 80 column dot matrix printer for use with personal computers. Available in tractor or friction feed versions printing the full 96 ASCII alpha-numerics and graphics at 150 cps. The special ruby jewelled needle guide gives the print head a life in excess of 100 million characters.
- 80 std. or 40 double width char/line
 - 150 cps 7 x 5 matrix 70 lines/min
 - 96 ASCII set provides upper & lower case plus graphics
 - Parallel data inputs – Centronics compatible
 - 220/240V 50Hz 100 watts
 - 16" W x 13" D x 5" H 21lbs
 - Paper low detector. Built in self test feature
 - Power ON/OFF and paper feed controls
 - Supplied complete with operating manual, mains lead and ink ribbon

Special Offer!

you could **SAVE**
up to **£130**

Attach this Advertisement to your order for a TX-80 and we will include an Interface card and connecting cable **FREE**. Specify type of micro used. Models available ex-stock for **APPLE, PET, TANDY** – with or without expansion box. RS232, current loop and IEEE 488.



order now from

Barclay-Visa-Trust and other credit cards accepted

DATAPLUS

DATAPLUS LTD 39-49 ROMAN ROAD
CHELTENHAM GL51 8QQ Tel: 0242 30030
Telex: 43594

SYSTEMS HOUSES, OEMS and DEALER ENQUIRES WELCOME



apple computer
Sales and Service

• Circle No. 255

PRACTICAL COMPUTING July 1980

S.C.C. MICROCOMPUTERS

We supply a wide range of micros and provide expert advice, from selection through software to installation, training and after sales support of hardware and software. e.g.

- PET
- APPLE II
- SUPERBRAIN
- ALTOS
- EQUINOX SERIES

Peripherals: Anadex, Commodore, Teletype, Texas 810, Qume, Adds, Lear Siegler etc.

Our requirements Analysis will ensure a cost effective system for today and tomorrow.

S.C.C. MICROSYSTEMS

We have in-house expertise in interfacing microcomputers to Electronic Equipment in a wide variety of applications. E.g.

WEIGHING:-

Monitoring and analysing batch and continuous weighing processes (to Government and E.E.C. requirements).

DATA COMMUNICATION:-

Using a microcomputer as an intelligent satellite to other computers - chaining of microcomputers.

DATA LOGGING:-

Machine and high level language routines for translating outputs from electronic sources. PROM resident software developed where required

CONTROL APPLICATIONS:-

Software developed to monitor and control analogue or digital receptors.

N.C. & TELEX TAPE PREP.

Easy solutions for error free production, editing and storage of programs/data.

MAPCON CONSULTANCY:-

GRANTS AVAILABLE up to £2,000 from the Department of Industry - where appropriate.

FREE ADVICE & DEMONSTRATION!

Let our Requirements Analysis and after sales SYSTEMS SUPPORT HOTLINE guide you onto, and keep you on the path to prosperity.

Contact the professionals at:- 225, ABBEYDALE ROAD, SHEFFIELD. S7 1FJ. Tel: 53519.
Open Monday to Saturday 9a.m. to 5.30p.m. other times by appointment. 1½ miles from City Centre on A621 Bakewell Road, 6 miles from M1

S.C.C. MICROSOFTWARE

PACKAGE SOFTWARE

We have a wide range of applications software and can tailor packages to suit client's individual requirements e.g.

**SALES, PURCHASE AND NOMINAL LEDGER
STOCK CONTROL, INVOICING**

PAYROLL

INCOMPLETE RECORDS FOR ACCOUNTANTS

TIME RECORDING AND COSTING

ESTATE AND INSURANCE AGENTS

LICENSED TRADE STOCK-TAKING

WORD PROCESSING, MAILING LISTS

CUSTOM SOFTWARE

We provide analysis, specification, programming and installation services to suit client's requirements.

SOFTWARE MAINTENANCE AND SERVICE

All of our clients have access to our HOTLINE SERVICE to answer their queries.

S.C.C. CONSULTANTS

We provide Consultancy in the application of microcomputers to:-

- ACCOUNTS & COSTING SYSTEMS
- STOCK CONTROL
- ORDER PROCESSING
- PRODUCTION CONTROL
- FINANCIAL PLANNING SYSTEMS
- MODELLING TECHNIQUES
- INDUSTRIAL ENGINEERING & OR
- INTERFACING
- DATA COMMUNICATIONS

TRAINING COURSES & SEMINARS

arranged with clients to suit their Company's educational needs.

MAPCON CONSULTANCY

Department of Industry GRANTS TO £2,000 available in appropriate cases.

SHEFFIELD COMPUTER CENTRE

Alan G. Williams-Morgan
C.Eng, B.Sc (Hons), M.Inst.E.
Dr. Leslie Phillips D.Sc., PhD.
Kenneth Jones B.Sc. (Hons)
Chris Mooney

Tandon MINI FLOPPY DISC DRIVES

THE PROFESSIONAL DRIVE. NOW AVAILABLE FOR THE FIRST TIME TO PERSONAL COMPUTER USERS.

Complete Add — on boxed drives and integral power supply for TRS-80, North Star Horizon, Cromemco, S.W.T.P., Superbrain, Heathkit, Triton and others.

Now you can buy the Tandon drives which are supplied by your computer manufacturer as standard equipment, in boxed form ready to go, direct from the OEM distributor with full after sales service and user warranty.

Fast access — 5ms track to track
High Capacity — 40 track

Highest reliability and accepted industry standard — over 70,000 of these American mini floppy drives are in use worldwide. Tandon drives are standard equipment on many professional computers including North Star, Cromemco, Wang, Ontel, Wordplex and many others.

Single Disc Units

Single Sided	£250.00	Double Sided	£340.00
		or 77 track	

Dual Disc Units

Single Sided	£430.00	Double Sided	£635.00
		or 77 track	

High quality Dysan diskettes for any of the drives also available.

HAL COMPUTERS LIMITED
 133 Woodham Lane New Haw
 Weybridge Surrey KT15 3NJ
 Tel: Weybridge (0932) 48346/7
 Telex: 8813487

• Circle No. 257

Get the answers before you get the problems

The Willis Catalogue of computer supplies is a complete range of products to meet the requirements of computer users.

We include flexible discs, cassettes, cartridges, storage equipment and filing systems, ribbons and labels.

A full range and first class back up service means you can check the Willis Catalogue first for all your needs.

For your copy of our latest catalogue Phone Bishops Stortford (0279) 506491 or send coupon.



WILLIS

Computer Supplies,
for people who know better

To: Willis Computer Supplies Ltd., P.O. Box 10 Southmill Road,
Bishops Stortford, Herts. CM23 3DN.
Please send me your Catalogue.

Name _____

Company Address _____

PC7

• Circle No. 258

ITT 2020 (16K) £645

Send cheque payable to Guestel Limited. 7-day delivery.
 16K - £759, 32K - £833, 48K - £906 inc. VAT.

WORD PROCESSING FOR ITT/APPLE

The unique Guestel 360 letter writer combining text editing facilities with advanced mailing list and associated attributes file. All in machine code. The best letter writer available to-day at only — £230 complete with plug in lower case board. £190 for those people who already have an LCB. A complete system ready to use, including Daisy-wheel printer, twin discs, etc. Unbeatable at £3,430.

GRAPHICS TABLET

Complete and ready to use with ITT operating program. Includes RS232 Interface and pen stylus £895.00.

PLUG IN LOWER CASE BOARD

Increase the capability of your ITT 2020 to include lower case flashing and normal characters. £45.00

NOW APPLE DEALERS

Courses available in Machine Code & Basic Programming. All prices ex. VAT & PP.

Guestel Limited, Refuge House,
 2-4 Henry St, Bath BA1 1J. Tel: Bath 65379.

• Circle No. 259

SIRTON COMPUTERS



76 Godstone Road, Kenley (Nr Croydon) Surrey CR2 5AA
Tel: 01-688 0761/2

MIDAS S.100 SYSTEMS



MIDAS 1 : From £895
MIDAS 2 : From £1880
MIDAS 3: From £2460
MIDAS 4 : From £6300

- Our versatile Z80 Microcomputers are available as standard units or custom configured to your exact specification from a comprehensive range of stocked S100 boards.
- Disc storage capacity of the MIDAS 3 can be 2M Bytes, expandable to over 20M Bytes with a Winchester Hard Disc Unit in our MIDAS 4 range.
- MIDAS runs CP/M and MP/M is also available. Other Software includes M-BASIC, C-BASIC, FORTRAN, COBOL, CIS-COBOL, PASCAL and Word Processing.
- A MIDAS 3, with 64K RAM and 2M Bytes storage on two 8" drives with two Serial I/O Ports and CP/M 2 only £3200.
- Printers, VDUs and other peripherals stocked to give complete package systems at keen prices.
- Business Packages include Accounts, Stock Control, Purchase Ledger etc etc.
- OEM and Dealer enquiries welcome.

ITHACA DPS-1



With 4 MHz MPU-80 (Z80) CPU from £895.
All Ithaca boards and many others available
to make complete system.
Also companion dual 8" Disc Drive Enclosure.

WRITE OR PHONE FOR CATALOGUE
SIRTON COMPUTERS WAS FORMERLY SIRTON PRODUCTS

Printing Speed - 40 C.P.S.
 Character-set - 96 characters, metal faced printwheel
 Choice of typefaces
 Line width - 136 characters (10 characters per inch)
 Line width - 163 characters (12 characters per inch)
 Form width - 16"
 Integral PET IEEE-488 Addressable Interface
 (Disc compatible)

240v 50Hz
 Micro-Processor controlled
 Reputation for high reliability
 Options:-
 Pin Feed Platen
 Acoustic cover
 Form Tractor
 RS232 C Interface, Centronics Interface

Complete word processing systems - Commodore PET,
 Software and RP40 Printer also available.

HIGH QUALITY PRINTING AT LOW COST £1590.00 inc. PET INTERFACE.



2/4 Canfield Place · London · NW6 3BT Telephone 01 328 7145/6, Telex 8813085 (Abacus)

**small systems
 presents**

**PET COMPATIBLE
 DAISY WHEEL
 PRINTER**

S.S.E. RICOH RP40

• Circle No. 261



**You'll need us when
 the CRUNCH comes**

Complete Business Systems for under £2,500.
 A selection of our Business Programs are:

- | | |
|--------------------|-----------------------|
| 1. Stock Control | 5. Ledgers |
| 2. Invoicing | 6. Incomplete Records |
| 3. Word Processing | 7. Payroll |
| 4. Data Base | 8. Cash Flow |

Add a Corvus Disk to the Apple and have ten Mega-
 bytes of storage at your fingertips.
 Also on view: North Star, Pet, and Sharp.

See us at: **28 Lower Addiscombe Road,
 Croydon, Surrey.**

Our Phone: **01-680 4646**

• Circle No. 262

MICRO BUSINESS CENTRE

CASTLEBRIDGE HOUSE, LICHFIELD RD, WEDNESFIELD
 WOLVERHAMPTON. TEL. WOLVERHAMPTON 725687

**OUR NEW SHOWROOM
 IS NOW OPEN**

**AUTHORISED
 DEALERS ***

**APPLE II
 ITT2020**

* SPECIALISTS IN THE COMPUTERISATION *
 OF SMALL BUSINESSES

A FULL RANGE OF
QUALITY BUSINESS SOFTWARE INC
 SALES * PURCHASE * NOMINAL LEDGERS
 STOCK CONTROL * WORDPROCESSOR
 INCOMPLETE RECORDS * CASH FLOW
 WIDE RANGE OF GENERAL/GAMES
 PROGRAMS.

*** BEGINNERS BASIC TWO DAY *
 PROGRAMMING COURSES**

TEL FOR DETAILS & DATES AVAILABLE

PLEASE SEND DETAILS AS INDICATED

NAME.....
 ADDRESS.....

SOFTWARE HARDWARE COURSE

OTHER PLEASE SPECIFY.

PC7

• Circle No. 263

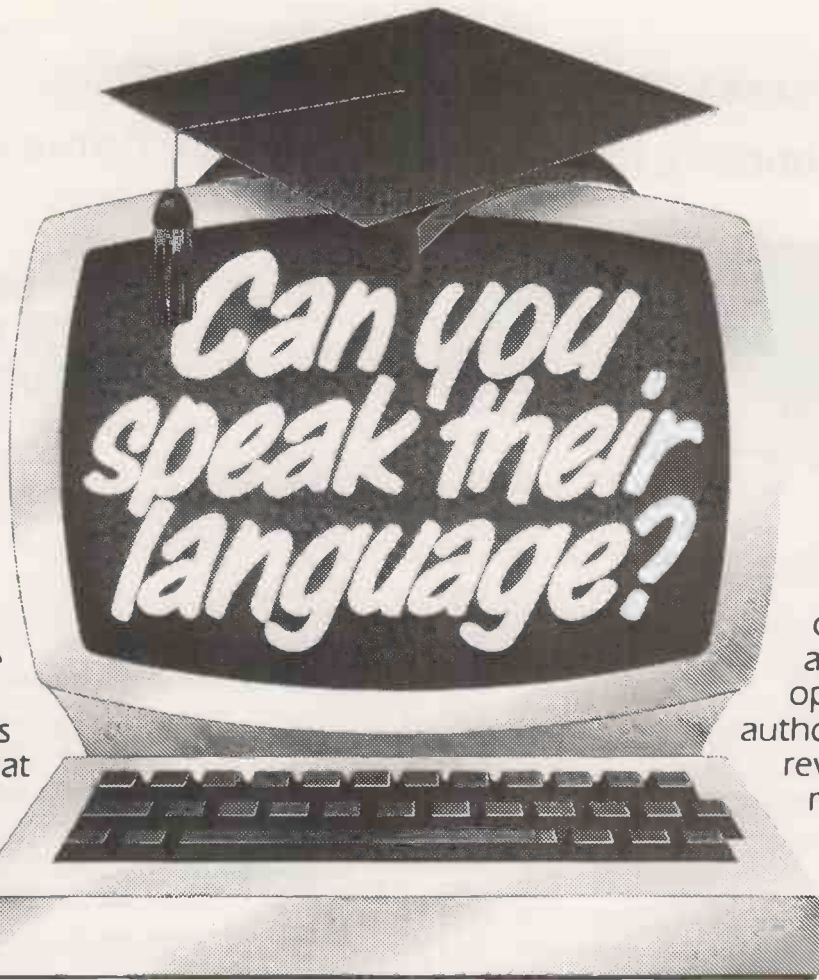

EDUCATIONAL COMPUTING is the new magazine for everybody who has ever wondered what the microcomputer revolution has meant to education. Here's your chance to find out everything about the use –

and study – of computers and their peripherals in schools, colleges and universities.

Computer services have an obvious part to play in the educational process itself. As well as providing important opportunities for your students to learn many skills which could be vital to their futures, you will benefit personally by greater familiarity with the one subject that's undeniably changing everyone's life.

This unique magazine will offer penetrating investigations into the educational applications and implications of data processing systems; full details of available

courses, examinations, and career options; and an authoritative range of reviews – of equipment, software, programs, and books currently on the market.

And our "Beginners' Guide" really

does start right at the beginning, with advice on raising the finance for your hardware, and how to be sure you're choosing the right system for your needs.

Teachers and students alike will want to use **EDUCATIONAL COMPUTING** to keep them abreast of the latest technological developments. As one of the ECC family of top computer publications, you'd be right to expect a knowledgeable – and entirely unpartisan – editorial approach. This is a complex and challenging new field, where there is always something new to learn. So don't risk being left behind. Send the coupon today.

Please enter my subscription for ten issues at the annual rate of £5. I enclose a cheque/PO.
Please charge my credit card (delete as applicable).

Name Title

School/College/University

Address

..... Signature

Type of card No:

Send to: **EDUCATIONAL COMPUTING**, ECC Publications Ltd., 30/31 Islington Green, London N1 8BJ.

PC7

• Circle No. 264

Erase Eproms in 8 minutes for under £100

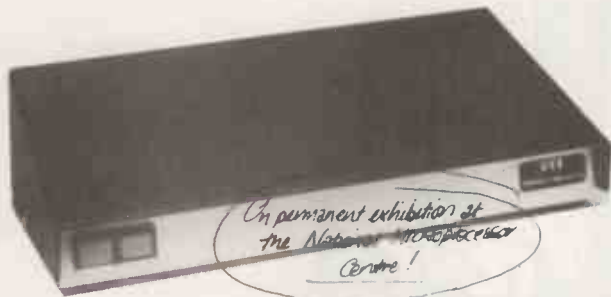

The high speed, high capacity model UV8 sets new performance and price standards.

- Cuts typical erasure times by a factor of 5
- 8 MINUTE SOLID STATE TIMER
- Capacity up to 14 EPROMS
- 2708 type erased in 4 to 7 minutes
- High intensity 254 NM UV source
- Safety interlock automatically starts timing sequence
- Audio tone signals erasure cycle complete
- Internal switch to extend erase time.

MICRODATA Computers Ltd, Belvedere Works, Bilton Way, Pump Lane Industrial Estate, Hayes, Middlesex.

Telephone (01) 848 9871 (6 lines) Telex 934110

• Circle No. 265

AERCO GEMSOFT APPLE 2 Comes to Woking!

Aerco Gemsoft have just opened their new computer division in Woking and invite you to drop in for a look at some real computers:—

APPLE 2 SUPERBRAIN MICROSTAR 45 OHIO SCIENTIFIC

We are official Apple agents and southern area distributors for the Intertec Superbrain.

Apple 2 16K (Europlus B & W)	£750.00
Superbrain 64K (Twin Disks)	£1995.00
ITT 2020 16K (Colour)	£867.00
Microstar 45 Plus	£4950.00
Apple 2 Disk Units from	£355.00
16K Memory Upgrade Kit	£69.00
Serial/Parallel Interface Card	£110.00
Pascal Language Card	£296.00
Anadex DP-8000 Printer	£570.00
9" Hitachi Monitor	£132.00
12" Hitachi Monitor	£210.00
Auto-Start ROM	£40.00
Eurocolour Card	£69.00

DISK BASED BUSINESS SOFTWARE FOR APPLE 2/ITT 2020

Sales Ledger Payroll
Stock Control General Ledger
Invoice Printer Price List Maintenance
Please add 15% VAT to above prices.

Send S.A.E. for full catalogue containing over 100 programs for PET, Apple & Exidy Sorcerer. Trade enquiries welcome.

Gemsoft can supply you with a complete (and fully expandable!) Apple system off the shelf including twin disks & printer for £2431 + VAT.

We specialise in designing complete systems and our expert in-house programmers are available to write any customised software from business systems, through industrial control systems to scientific and research programs.

GEMSOFT LTD, 27 Chobham Road, Woking, Surrey. Phone Woking (04862) 22881.
Open 6 days a week 9.30-5.30 p.m.

• Circle No. 266



The Strong Silent Type



- Line printer quality at character printer price.
- 300 lines per minute.
- Serial or parallel interface.
- Centronics or Dataproducts Compatible.
- Electronic Vertical Forms Control.
- Highly efficient sound reducing cabinet.

OEM PRINTERS FROM

KODE

Station Road, Calne, Wiltshire SN11 0JR.
Telephone Calne (0249) 813771. Telex 449335

• Circle No. 267



8300 RM PRINTER

80/132 ch per line (switchable); 125 c.p.s.; 2K Buffer; V24 RS232/Current loop interface; Speed switchable between 110-9600 baud; Double width char. available under software control; sprocket feed; 7 x 9 dot matrix; Paper width 4.5" to 9.5".

Price **£525 + carriage**

SPECTRONICS U.V. EPROM-ERASING LAMPS

PE14	Erases up to 6 chips, takes approx. 19 mins	£ 56.00
PE14T	Erases up to 6 chips, takes approx. 19 mins	£ 76.58
PE24T	Erases up to 9 chips, takes approx. 15 mins	£111.22
PR125T	Erases up to 16 chips, takes approx. 7 mins	£237.84
PR320T	Erases up to 36 chips, takes approx. 7 mins	£384.09

U.V. EPROM ERASING CABINET

PC1000	Erases up to 72 chips, takes approx. 7 mins	£842.83
PC2000	Erases up to 144 chips, takes approx. 7 mins	£1227.69

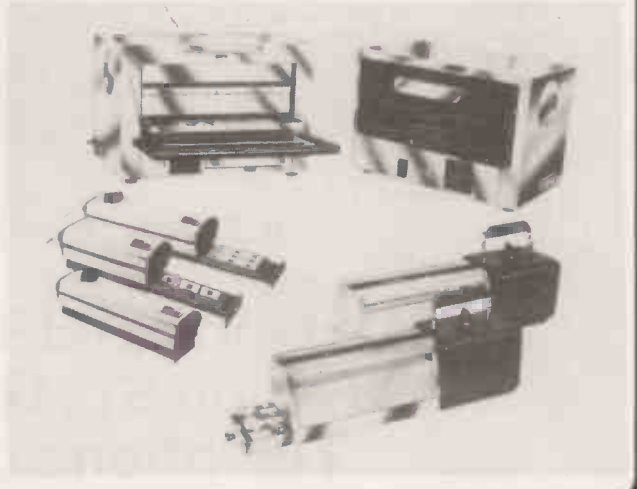

SHARP MZ80K

Z-80 based CPU; 4K bytes monitor ROM; Internal memory expansion up to 48K bytes of RAM; 14K extended BASIC (occupies 14K bytes of RAM); 10" video display unit - 40 characters x 25 lines; 80 x 50 high resolution graphics; 78 key ASC11 keyboard alphabet (capital & small) plus graphics; Built in music function; Fast reliable cassette with tape counter-1200 bits/sec.; 50 pin universal BUS connector for system expansion-printers, floppy discs etc.

FROM		£520.00
Machine code tape and manual	£19.00	Sharp Monitor Listing (fully commented) £15.00
Assembly code tape and manual	£45.00	Sharp basic manual £ 7.00

Look!

SPECIAL OFFER

2708	£ 5.99
4116	£ 5.99
2716(5v)	£18.50

NEW BOOKS

	AUTHOR	PRICE
The S100 and other Micro-buses Software Development	Poe	£ 5.15
Computers & Commonsense Architecture of Small Computer Systems	Jones	£14.45
	Hunt	£ 3.95
Principles of Data-base Management	Lippiatt	£ 4.50
16-bit Microprocessor Architecture	Martin	£12.99
6502 Assembly Language Programming	Dolhoff	£16.70
Introductory Experiments with Digital Electronics and 8080A Book 1	Osbourne	£ 6.95
Book 2	Rony	£ 8.40
	Rony	£ 8.40
Microcomputers for Business Applications	Barden	£ 5.80
Handbook of Microprocessors, Microcomputers and Minicomputers	Lenk	£11.65
Introduction to Microprocessors	Levanthal	£ 9.45
The VNR Concise Encyclopedia of Mathematics	Gellert	£15.35
Micro Program Software Development	Duncan	£13.45
Handbook of Electronic Analysis Using Programmable Calculators	Murdock	£19.90

GAMES

32 Basic Programs for the PET	Rugg	£ 8.90
Game Playing with Computers	Spencer	£10.20
Game Playing with Basic	Spencer	£ 4.20
Star Ship Simulation		£ 5.10
SARGON		£ 9.50

BASIC

The Basic Handbook	Lien	£11.00
Learning Level II	Lien	£11.00
Basic with Business Applications	Lott	£ 8.40
Illustrated Basic	Alcock	£ 2.50

Z80 BOOKS

Introduction to TRS80 Graphics	Inman	£ 5.75
Z80 Instant Programs (book) for Nascom	Hopton	£ 7.50
Z80 Instant Programs (cassette) for Nascom	Hopton	£10.00
Z80 Assembly Language Programming	Osbourne	£ 8.15

6502

Programming the 6502	R. Zaks	£ 7.95
6502 Applications Handbook	R. Zaks	£ 7.95

Terms: Official Orders (min. £10). Barclaycard & Access welcome. Add 15% to hardware prices. Book prices include p & p. Send for catalogue and booklist. All mail order to Newbury.

Mail Order & Head Office: 40 Bartholomew Street, Newbury, Berks. Tel: 0635 30505

Manchester Showroom: 220-222 Cheadle Heath, Stockport. Tel: 061-491 2290

Birmingham Showroom: 1st Floor Offices, Tivoli Centre, Coventry Road, Birmingham. Tel: 021 707 7170

ARRAY Processing from Silicon Glen on the West Coast of Scotland

VIDEO VECTOR DYNAMICS Ltd. announces what will be one of the most significant innovations in microcomputing during the 1980s — the VP-9500 vector processor. The VP-9500 is a British-designed and manufactured vector processor consisting of a two to 16 long vector of pipe-lined floating point processors with individual data stacks, optimised to operate on arrays of floating point numbers of up to 16,384 elements. The VP-9500 provides floating point processing at up to 200 times faster than ordinary 4 MHz Z-80A microcomputers and 20-30 times faster than a PDP-11/34. The benchmarks on which these figures are based may be obtained on request.

The VP-9500 is constructed on one (up to 8 elements) or two (9 to 16 elements) glass fibre PCBs with full solder masking and silk-screened component locations. The precision board lay-out was generated on a CAD facility and etching was performed for us by the U.K.'s leading PCB manufacturer. The VP-9500 has its own on-board crystal clock and DIP switches allow it to be placed anywhere in the I/O space of any S-100 microcomputer running at any clock speed.

Every VP-9500 comes complete with VPLIB, our library of Microsoft FORTRAN-callable array processing routines. Typical calls to FPLIB are CALL VSQRT (A,C,N) where the square roots of all of the N floating point numbers in array A are calculated and placed in array C; and CALL VMUL (A,B,C,N) where the N elements of array A are multiplied by the corresponding elements of array B and the results stored in array C. VPLIB contains over 100 such routines.

The VP-9500 is designed for those high-speed, computationally-intensive tasks such as real-time collection/processing of video data, finite element analysis, crystallography, molecular modelling, graphics, signal processing and large-scale scientific/engineering calculations which are beyond the capabilities of conventional micro and minicomputers.

All VP-9500s are field-upgradeable to the top-of-the-range VP-9500/16. Optional extras include a front panel display (to replace the on-board display) to monitor the performance of the VP-9500, an S-100 EPROM card containing complete diagnostic software, a scalar FORTRAN library FASTLIB which replaces Microsoft's FORLIB by calls to the VP-9500 in addition to providing extra FORTRAN functions (TAN, ASIN, ACOS, SINH, COSH, NINT & RAN), custom additions to VPLIB and full maintenance contracts.

And the cost? From approximately £1,600 for a VP-9500/2, through £3,400 for the VP-9500/8 and up to £5,800 for the top-of-the-range VP-9500/16. Complete microcomputer systems in our MVP range include the MVP-9500/16 based on a 64KB, hard disc, Z-80A microcomputer with VDU and software for around £11,000. This is £5,000 cheaper than a PDP-11/34 system 20-30 times slower than MVP-9500/16.

If you need fast floating point performance but your requirement or your pocket doesn't run to a VP-9500, then you're looking for our scalar processor. The SP-9500 in conjunction with FASTLIB makes your existing Microsoft FORTRAN programs run up to 20 times faster simply by plugging in the SP-9500 board and replacing FORLIB with FASTLIB. The hidden bonus is that the SP-9500 uses a depopulated VP-9500 PCB and field hardware upgrading and integration of VPLIB is simplicity itself. The SP-9500/FASTLIB package costs £495.

Get into the '80s, the decade of the array processor, by contacting us at:

VIDEO VECTOR DYNAMICS LTD
39 Hope St., Glasgow G2 6AE;
Telephone 041-226-3481/2

• Circle No. 269

IN-HOUSE VIEW DATA SYSTEM

Full specification colour viewdata system,
 compatible with Ceefax, Prestel etc.
 Implemented on Cromenco, North Star
 or an existing S100 machine.

Uses unmodified tv.
 Single or multi-user,
 up to 11,000 frames stored.

Intelligent 'soft-key' frame-editing.
 Modem/autodialler will allow interface to Prestel,
 the Post Office Viewdata system,
 or other distant viewdata bank.

Prices from £800 to £15,000

hi-tech electronics

1 Richmond Gardens, Highfield Southampton SO2 1RY
 Telephone (0703)555072

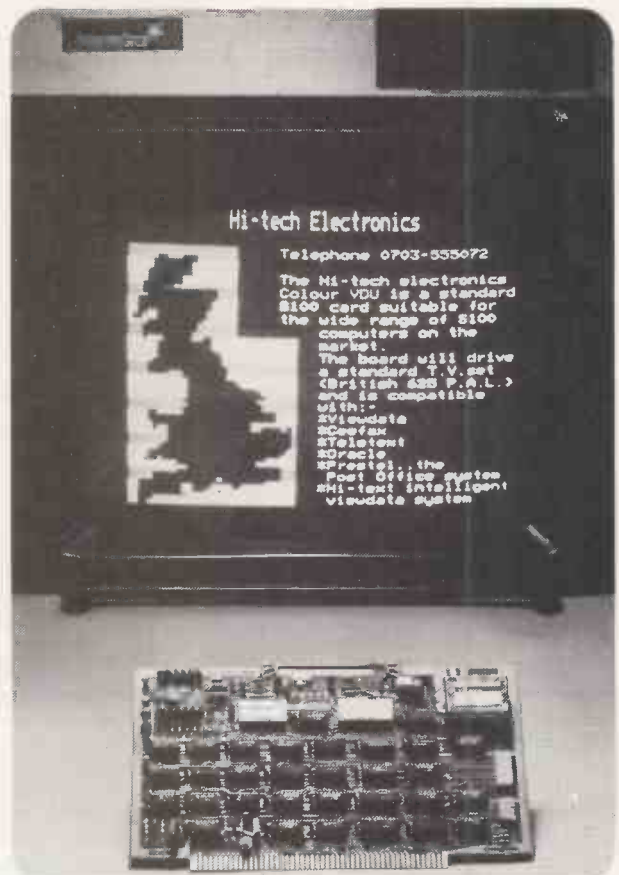

• Circle No. 270

NEW EDITION FOR BOTH OLD & NEW ROMS

ESSENTIAL READING FOR ALL PET USERS

THE PET REVEALED

ALMOST 180 PGES OF SOLID INFORMATION FEATURING:

PET circuit diagrams — How to use the diagnostic routine — PET ROM subroutines and their entry points — Programming in machine code — Using the IEEE and User Ports — Double-density graphics — Uncopyable programs — Page zero locations and their uses — A TRACE program for Basic program debugging — Disabling the keyboard and/or the Stop key — Adding a repeat key — Line re-numbering — Auto line erasing — Making the PET write its own programs — Printer interfaces — Adding new commands to Basic — Interrupts and multiprocessing.
Plus many more fascinating facts about the PET.



commodore

APPROVED PUBLICATION

Send cheque for £10.00 made payable to Computerbits Ltd.

COMPUTERBITS LTD

PO BOX 13, YEOVIL, SOMERSET. TEL. YEOVIL 26522

• Circle No. 271

**MICRO-COMPUTERS IN
WATFORD
ARE AT THE ...**

**BUSS
STOP**

PET		KIM	
8K RAM	£379.00	KIM1	£93.00
16K RAM	£495.00	KIM 3B	£96.95
32K RAM	£625.00	KIM 4	£65.00
DUAL DISK DRIV	£625.00	PET-IEEE LEAD	£18.75
PRINTER FRIC	£337.00	IEEE-IEEE LEAD	£23.44
PRINTER TRAC	£383.00	PETSOFT TOOL KIT FOR	
EXT CASSETTE	£49.50	16K/32K	£55.00
FULL RANGE OF INTER-		8K	£75.00

FACES AVAILABLE FOR PET

NASCOM 2 — SYSTEM 80

NASCOM 2 — KIT WITH 16KRAM	£295.00
NASCOM 2 — BUILT WITH 16KRAM	£360.00
NASCOM IMP PRINTER	£325.00

PLEASE PHONE FOR SYSTEM 80 PRICES

VIDEO GENIE EG 3003 — 16KRAM

FULLY TRS80 LEVEL II COMPATIBLE!!

THIS READY TO GO SYSTEM ONLY £339.00

NEW-DOLPHIN BD80P PRINTER

PET/IEEE, PARALLEL OR RS232 INTERFACE BUILTIN.
UNBEATABLE BRITISH VALUE AT £525.00

SOFTWARE — 10C12's	£4.50
PETSOFT 10.5 1/4" DISKS	£25.00
BRISTOL 1000 SHEET OF PAPER	£8.40

SOFTWARE FACTORY COMMODORE BUSINESS
SOFTWARE WIDE RANGE OF BOOKS & MANUALS IN
STOCK PHONE FOR KEENESTO.E.M. AND
EDUCATIONAL USER PRICES

PLEASE PHONE FOR CARRIAGE CHARGES ALL PRICES
+ VAT CHEQUES TO PHOTOACOUSTICS LTD.

Ring Rod EVA for details or just call in at the BUSS STOP

255a St. Albans Road, Watford, Herts. (entrance in Judge Street)
Phone: Watford 40698 or Newport Pagnell 610625

• Circle No. 272

**MONITORS
MONITORS
MONITORS**

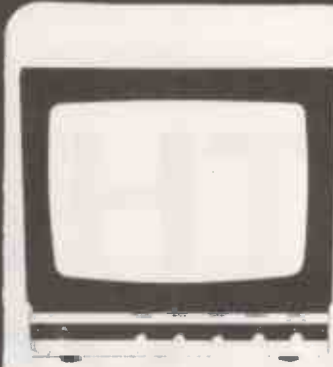

UNCASED 9"
UNCASED 12"
CASED 9"
CASED 10"
CASED 12"
MONITOR TUBES

SELF CONTAINED MONITOR PCB's

**CROFTON
ELECTRONICS**

Crofton Electronics Limited
35 Grosvenor Road, Twickenham, Middlesex.
Tel: 01 891 1513

• Circle No. 273

c s
ca is
cad dis
cadd ddis
caddi addis
caddiscaddis
caddi addis
cadd ddis
cad dis
ca is
c s

Specialists in micro-computer applications

Caddis Computer Systems Ltd



COMMODORE	
8K PET Graphics Keyboard	
8K PET Business Keyboard	
16K PET Business Keyboard	
32K PET Business Keyboard	
PRINTER 3022	
DISKDRIVE 2040	
CASSETTE DRIVE	
COMPUTHINK	
DISKDRIVE 400K old ROM	
DISKDRIVE 400K new ROM	
DISKDRIVE 800K new ROM	
TELETYPE 43	
DECWRITER LA34	
SHARP MZ80K 32K Model	
(old models available)	

RRP	CADDIS
475	427
450	405
675	608
795	716
525	500
795	755
55	50
795	755
895	850
1145	1088
900	825
925	825
740	666

CADDISS INTERFACES Full range for professional and hobbyist applications e.g. IEEE488 to RS232C; PARALLEL I/O; Analogue I/O etc.
SOFTWARE Full range of Business and Education Software by ACT, COMMODORE, H.B., PETSOFT etc.
DESIGN Our team of professional engineers will design interfaces, software packages, or systems to your requirements.
LEASING facilities available to suitable clients.
DELIVERY arranged by REDSTAR or SECURICOR.
ALL EQUIPMENT CAN BE SUPPLIED MAIL ORDER (Cash with Order Please).

72-74, TRINITY LANE, HINCKLEY, LEICS.
TEL. HINCKLEY (0455) 613544

ALL PRICES EXCLUDE VAT

• Circle No. 274

NEW!

MPI MODEL 88T IMPACT MATRIX PRINTER

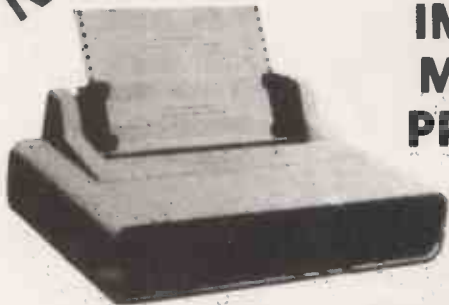

**£535
+ VAT**

The first of a series of new, full-capability, low cost, high performance printers designed by MPI to meet the requirements of the general use computer market - hobbyist or professional.

SPECIFICATIONS

- Impact Bidirectional
- 7x7 Dot Matrix
- 100 Characters Per Second
- 80, 96 and 132 Column
- 10 Lines Per Second
- Tractor and Friction Feed
- Normal Paper: Roll, Fan-fold or Cut Sheets
- 115/230 VAC ±10%, 50/60 Hz
- 96 ASCII Upper and Lower
- RS232C: 20 ma. Current Loop
- 110-1200 BAUD
- 2 Line Buffer;
- 1 or 2 K Optional
- Centronics Parallel
- 41x27x16 cm; 7 Kg.

SIGMA (U.K.) is the U.K. distributor for MPI and seeks dealers nationwide.

**SIGMA (U.K.)
UNIT 2
106-120 GARRATT LANE
LONDON SW18**

THE FIRST MICROCOMPUTER WHOLESALE



We offer products from many manufacturers including:

- | | | |
|--------------|-------------------|-------------------|
| Altos | Houston Inst. | N.E.C. |
| Base 2 | Impact Data | North Star |
| Centronics | Industrial Micro | Ohio Scientific |
| Century Data | Integral Data | PerSci |
| Control Data | Intertec | Qume |
| Dyna Byte | Konan | Soroc |
| Exidy | LRC Eaton | Televideo |
| Hazeltine | Micro Peripherals | Texas Instruments |

**SIGMA (U.K.)
UNIT 2
106-120 GARRATT LANE
LONDON SW18**

Telephone: 01-870 4524 Telex: 8954572 HOMLIV

IMPACT DATA MODEL 801

THE HEAVY DUTY WORKHORSE
AT THE
AFFORDABLE PRICE.

**£695
+ VAT**

- 7 x 7 Impact Dot Matrix
- 132 CPS (max.)
- 96 Character Upper/Lower ASCII
- 8.0 in. (20.3 cm) Line Length
- 80 or 96 Columns
- 6 LPI Line Spacing
- Tractor or Friction Feed
- 127 Character Buffer - 2 K Optional
- Feed at 50 LPM Printing - 560 LPM Sewing
- Continuous Loop Ribbon with Re-inking Roller - 5 Million Character Life
- Paper is Standard Fan-fold, Multi-copy Computer Forms up to 9-5/8" (24.45 cm)
- 8-bit Parallel (Centronics Compatible), RS232 or 20 ma. Current Loop Interfaces, 110/1200 BAUD, Switch Selectable
- 115 VAC, 3A, 60 Hz. or 220 VAC, 1.5A, 50 Hz.
- 12"H x 18"W x 14"D (30 x 45 x 35 cm)

High Quality • High Technology • Low Price

Substantial Dealer/Distributor
Discounts Available

**SIGMA (U.K.)
UNIT 2
106-120 GARRATT LANE
LONDON
SW18**

LRC EATON MODEL 7000+ IMPACT PRINTER

**£250
+ VAT**

- Simple Design
- Simple Maintenance
- Simple Interfacing to:
 - Apple
 - Pet
 - TRS-80
 - Exidy
 - OSI
- and many other personal computers



The 7000+ was designed to provide the personal computer user with an inexpensive, yet reliable printer. Take a look - you won't regret it!

SPECIFICATIONS

- Impact Unidirectional
- 125 LPS 50 CPS
- 40 or 64 Column
- 5 x 7 Dot Matrix
- Standard Paper Rolls
- 100 Million Character Printhead Life (minimum)
- 6 LPI Line Spacing

Substantial Dealer Discounts are Available.

OEM inquiries are invited. Please contact:

**SIGMA (U.K.)
UNIT 2
106-120 GARRATT LANE
LONDON SW18**

L.B. ELECTRONICS

ASR 33 (TAPE PUNCH/READER) OVERHAULLED WITH NEW ROLL PAPER ETC £225 INC VAT
MEMOREX DUAL DISC DRIVES COMPLETE WITH PSU, FORMAT ELECTRONICS, FULLY CASES £350 INC VAT (UNTESTED, SORRY NO INFORMATION)
SHUGART 801 8" DISC DRIVES FULLY TESTED £300
MPU PCB 10½" x 15½" CONTAINING 24 x 2102 (IN SKTS), 8080A (IN SKT), 2708 (IN SKT), 92 x TTL. £28.50p. £1 p&p.

CANNON D TYPES

15 WAY (W/WRAP) PLUGS 75p
25 WAY (RIBBON) PLUS £1.40p
25 WAY (SOLDER) PLUGS £1.40p
25 WAY (SOLDER) SKTS £1.40p
37 WAX (SOLDER) PLUGS £1.40p
50 WAY (W/WRAP) SKT £1.65p
50 WAY (SOLDER) SKT £1.45p

D TYPE COVERS

37 WAY (PLASTIC) 80p
25 WAY (PLASTIC) 65p

MICRO IC'S

2526 (64 x 9 x 9) + DATA £2.95p
1702A £2.50p

WE STOCK SURPLUS COMPUTER EQUIPMENT, COMPONENTS, POWER SUPPLIES (NEW AND USED) WE ARE OPEN MON TO SAT 9.30 - 6.00. CLOSED ALL DAY WED.

L.B. ELECTRONICS,
11, HERCIES ROAD,
HILLINGDON, MIDDX.
TEL: UXBRIDGE 55399



2708 £6.25p
2716 (SINGLE 5V RAIL) £16

MINIFANS

PAPST 80mm x 80mm (APP)
220V 50HZ BRAND NEW
£8. p&p. £1
PEWEC AS ABOVE 115V
£4.50p. p&p £1.

SALE

SN 74116 60p
SN 74118 70p
SN 74194 50p
SN 74198 75p

STEPPING MORTARS

40mm DIA x 70mm LONG
SHAFT 5mm (APPROX)
12-24V TORQUE 340 GPC
BRAND NEW £2.50p.
p&p 40p.



SHARP MZ-80K
Basic, Assembler, Machine Code, Integral Cassette (1200 b.p.s.). Tape counter, built in speaker.
Up to 48K RAM.
From £520 + VAT



PET's
8K (Integral Cassette) — £520
8K (Large Keyboard) — £520
16K — £625 32K — £730
10% discount on petsoft software

PET HIRE

FROM £4.25 per day
Weekly & Monthly rates on application
Up to 50% refunded if purchase results

Limited Number of Ex-Demo/Hire Machines Available:-
PET 8K (Old ROM) — £475 Sharp 34K — £655
PET 16K & Cassette — £630

Telephone for demonstrations (Your premises or Ours)
All prices subject to VAT

ESSEX COMPUTER SERVICES

10 Grafton Road
Canvey Island
Essex SS8 7BT
Tel: Canvey Island (03743) 61663



• Circle No. 276

• Circle No. 277

In celebration of the opening of our new branches in Banbury & Swindon we are delighted to announce further additions to our extensive product range . . .

Hard copy at soft prices.

An attractively styled 80/132 column bidirectional matrix printer complete with cables and interface for under £450! Specification includes software selectable character size, 2K buffer, friction/tractor feed and up to 120 c p s

Take big bytes from your Apple.

Give up trying to squash your data or programs onto a 5¼" mini-diskette. Our new range of fast, low cost mass storage devices from 512K to 11 megabytes starts from around £1,750

The eyes have it. Tired of poor TV signal images? Up-grade to a professional video monitor. Our new lightweight 12" black and white monitors start from as little as £95.
Simulate to Stimulate Put action into your graphics with this 3 dimensional animated graphics software package. Use it to simulate flying or driving, to instruct on navigation or engineering design. Only £95.

For more details of these and our many other products contact your nearest branch.

The Computer Shop

Computers for Science, Business and Education.

54 High Street, Banbury, Oxon. Telephone: Banbury (0295) 3477
40 Prospect Street, Caversham, Reading, Berks. Telephone: Reading (0734) 481555
25 Havelock Street, Swindon, Wilts. Telephone: Swindon (0793) 694061

• Circle No. 278

All these only from HENRY'S



IN STOCK

FREE POWER SUPPLY

NASCOM-2 + FREE 16K RAM

Here's an offer you can't refuse: Because of the lack of availability of MK 4118 RAMs, Nascom Microcomputers is supplying its Nascom 2 without the 8 spare 4118s but with a FREE 16K dynamic RAM board.

When the 4118s become available, Nascom 2 purchasers can have them at the special price of £80 + VAT for the 8K. So, for £295 plus VAT this is what you get:

NASCOM-2 with 32K RAM
£345 + VAT
P&P 1.50

Buy British It's Best!!

- MEMORY**
- 16K RAM board (expandable to 32K).
 - 8K Microsoft BASIC.
 - 2K NAS-SYS 1 monitor.
 - 1K Video RAM.
 - 1K Workspace/Scratchpad RAM.
 - Main board sockets for the 8x4118s or 2708 EPROMS.

No more slaving over a hot soldering iron - the Nascom 1 is now supplied BUILT! Britain's biggest small system is available fully constructed for you to slot into your own housing for the ridiculously low price of £175 plus VAT (kit price still only £165 plus VAT). **EX-STOCK**

nascom 1

12" x 8" PCB carrying 5LSI MOS memory packages. There is on-board unmodulated operating

With NAS-SYS **SCOOP KIT NOW ONLY FULLY GUARANTEED**

NEW £140

MEMORIES	£.p.
2114	4.00
8 FOR	30.00
4116	7.50
8 FOR	55.00
2708	7.50
4 FOR	28.00
4118	12.75
4 FOR	48.00
2716	22.00

MICROPROCESSOR

- Z80A which will run at 4MHz but is selectable between 1/2/4 MHz.

HARDWARE

- Industrial standard 12" x 8" PCB, through hole plated, masked and screen printed. All bus lines are fully buffered on-board.

INTERFACES

- Licon 57 key solid state keyboard.
- Monitor/domestic TV interface.
- Kansas City cassette interface (300/1200 baud) or RS232/20mA teletype interface.

The Nascom 2 kit is supplied complete with construction article and extensive software manual for the monitor and BASIC.

EXPANSION NASCOM-1

*Expansion buffer board	£32.50
MEMORY KITS (inclusive all hardware)	
8K	£85
16K	£140
32K	£200
*I/O board with decoders and all hardware except ICS will accept up to 3 PIOs, 1 CTV and 1 UART	£35
NEW, T 4 operating system in (2) 2708 EPROMS UPWARDS COMPATIBLE FROM T2 and B-BUG	£25.00
NAS SYS 1. MONITOR	£25.00

Programming Manual	£4.50
*Power supply for up to 32K expansion Mk II	£24.50
*8A power supply for larger than 32K expansion	£60.00
*Expansion card frame	£29.50
EPROM programmer	£13.95
SMART-1	£74.95
Tiny Basic	£25.00
Super Tiny Basic (with editor and machine utility routines)	£35.00
Zeap assembler editor	£32.00
8K BASIC ROM	£40.00
Nascom Text Handler	£30.00
Disassembler	£9.95



NASCOM IMP
£325

NASCOM IMP PLAIN PAPER PRINTER

Fully built and housed in a stylish enclosure for just £325 plus 15% VAT. Interfaces with all micro computers. Deliveries Ex-Stock.

- Optional tractor feed.
- Baud rate from 110 to 9600
- External signal for optional synchronisation of baud

The Nascom IMP (Impact Matrix Printer) features are:

- 60 lines per minute
- 80 characters per line.
- Bi-directional printing.
- 10 line print buffer
- 96 character ASCII set (includes upper/lower case)
- Automatic CR/LF.
- Accepts 8 1/2" paper

HALF PRICE OFFER



EXCLUSIVE TO HENRY'S 50% OFF MAKER'S PRICE

- Software selectable 20, 40 and 80 column using 120mm aluminium-ised paper. 1 roll supplied.
- 150 lines per minute.
- Centronics parallel data interface for Nascom, Tandy, etc.
- 240volt mains input.
- ASCII character set
- Paper feed, and on/off select switches
- Audible 'BELL' signal
- Weight 10lbs
- Size: 13" x 10 1/2" x 4 1/2" LIST PRICE £400

80 column

Our Price £195.00

plus VAT post FREE

Spare paper £9 for 3 Rolls + VAT

CENTRONICS P1 PRINTER

FERRANTI COMPUTER KEYBOARDS

STURDY SOLID CASE



SIZE 14x6x3" SLOPING FRONT

60 Key ASCII Coded in steel case Latched output complete with Plug & Cable with circuit to convert to T.T.L. levels.

In good condition at only **£25 + VAT** P/P £2.50

Your London & National Nascom Distributor. **Export Orders** deduct VAT, but add 5% carriage **Official Export & Educational Orders welcome** Our Telex 262284 Mono Ref. 1400 Transonics

COMPUTER SEND BROCHURE FREE **SEND 15p STAMP**



Henry's
Computer Kit Division
404 Edgware Road, London, W2, England
01-402 6822



● Circle No. 279



**CRYSTAL ELECTRONICS
CC ELECTRONICS**

XTAL Basic 2.2 NOW ON SHARP MZ80K

All of the features of SHARP BASIC and more. Occupies 5K less memory, thus effectively increasing memory size for programs.

MZ80K 20K RAM £520+VAT
(with XTAL BASIC leaves 11K for programs)
XTAL BASIC for SHARP £40+VAT

Coming Soon—PETSOFT* programs in XTAL BASIC format for SHARP & NASCOM—
Prices as PETSOFT list+20%.

NASCOM 1 & 2 owners—XTAL BASIC 2.2 £35+VAT
NEW EPROM version £100+VAT
(please state monitor used)
EPROM version runs in EOOOH-FFFFH.

APPLE II PLUS OWNERS

APPLE INTEGER BASIC on disc for 32K or 48K APPLE.
Now you can run nearly *all* of your programs—
£20+VAT

* PETSOFT is a trademark of ACT PETSOFT LTD.

Members of Computer Retailers Association & Apple Dealers Association

Shop open 0930-1730 except Wed. & Sun.

40 Magdalene Road, Torquay, Devon, England. Tel: 0803 22699

Access and Barclaycard welcome.



COMPUTERS
AND
COMPONENTS

• Circle No. 280

INTEGRATED SMALL BUSINESS SOFTWARE ISBS

Professional Business Packages for Microcomputer systems include:

- PAYROLL
- STOCK CONTROL
- ORDER ENTRY & INVOICING
- COMPANY SALES
- COMPANY PURCHASES
- GENERAL ACCOUNTING
- NAME & ADDRESS SYSTEM

Available as individual modules or complete system to run on RAIIR BLACK BOX, NORTHSTAR, HEATH, CROMEMCO, DYNABYTE, IMS 5000/8000, ALTOS, ALTAIR, SUPERBRAIN, MICROMATION and most other 8080 based systems.

Contact Lifeboat Associates, 32 Neal Street, London WC2 or your nearest dealer.

GRAFFBOM 52 SHAFTESBURY AVENUE
SYSTEMS GROUP LONDON W1 01-734 8862

• Circle No. 281

LET'S TALK SENSIBLE PRICES

MPI MODEL 88T MATRIX PRINTER

Type of Printing	Impact bidirectional, 7 × 7 dot matrix
Print Rate	100 Characters per second
	Character Set Full upper & lower case 96 char. ASCII set
	Print Format 80, 96, or 132 characters per line
Media	Fanfold, single sheet or roll paper up to 9.5 ins. wide
	Paper Feed 10 lines per second. User selectable pressure roller or tractor feed.
	Data Input Parallel (Centronics compatible) RS232C; TRS-80; Apple (Parallel Printer Interface Card) 20ma Current Loop.
	Baud Rate 110, 150, 300, 600, 1200.
	Forms Control Top of Form (8 selectable form lengths) Skip over perforation.
	Operator Controls Top of Form Set, Forms feed, Self-Test Continuous Loop Cartridge, 20 yds 5 million character life.
	Ribbon
	Data Buffer Two lines standard, optional 1K and 2K.
Physical Dimensions	16.25 ins wide × 10.75 ins deep × 6.25 ins high. Weight: less than 15 lbs.

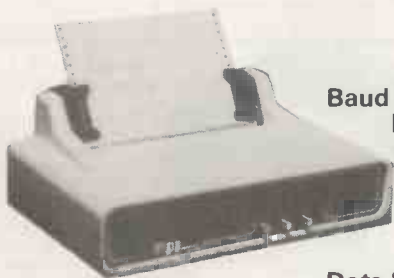

£485
+ VAT

COLIN BENTLEY ASSOCIATES LTD

4A Clock House, London Road, Waterlooville, Hants PO7 7EZ (07014) 51082

• Circle No. 282

**PRINTER
BREAKTHROUGH**

IF YOU FIND A BETTER PRINTER AT A BETTER PRICE — BUY IT INTERFACES WITH ANY MICROCOMPUTER

**ONLY
£350
+ VAT
NEW**

80-COLUMN IMPACT PRINTER

LOWEST IN PRICE— HIGHEST IN PERFORMANCE



'BASE 2' MODEL 800 MST
Complete with 2K terminal buffer, treater and high speed paper feed.

FEATURES:

- *Reliability
- *Low Cost
- *Auxiliary User Defined Character Set
- *RS-232, 20ma, IEEE 488 and Centronics I/O

16K STATIC RAM BOARD-S 100 BUSS

BOARD FEATURES

1. Addressable as four separate 4K Blocks.
2. ON BOARD BANK SELECT circuitry. (Cromemco Standard). Allows up to 512K on line.
3. Uses 2114 (450NS) 4K Static Rams.
4. ON BOARD SELECTABLE WAIT STATES.
5. Double sided PC Board, with solder mask and silk screened layout. Gold plated contact fingers.
6. All address and data lines fully buffered.
7. PHANTOM is jumpered to PIN 67.
8. LOW POWER: under 1.5 amps TYPICAL from the +8 Volt Buss.
9. Blank PC Board can be populated as any multiple of 4K.

**PRICE CUT!
£225 + VAT**



Assembled & Tested. Not a kit. OUR #1 SELLING RAM BOARD!

8K LOW POWER RAM KIT-S 100 BUSS

SALE

21L02
(450 NS RAMSI)

Thousands of computer systems rely on this rugged, work horse, RAM board. Designed for error-free, NO HASSLE, systems use.

£99. + VAT



PRICE CUT!

ASSEMBLED AND FULLY BURNED IN ALL BOARDS ARE TESTED AT 4MHZ

S-100 Z80 CPU CARD

ASSEMBLED AND TESTED! READY TO USE! Over 3 years of design efforts were required to produce a TRUE S-100 Z80 CPU at a genuinely bargain price!

FEATURES: BRAND NEW!
• 2 or 4 MHz Operation • Generates MWRITE, sc no front panel required • Jump on reset capability • 8080 Signals emulated for S-100 compatibility • Top Quality PCB

WIRED! NOT A KIT! 4 MHZ

Silk Screened Solder Masked Gold Plated Contact Fingers.

£110 + VAT

Perfect for OEM's

16K EPROM CARD-S 100 BUSS

FIRST TIME OFFERED! BLANK PC BOARD - 28 USES 2708's!

Thousands of personal and business systems around the world use this board with complete satisfaction. Puts 16K of software on line at ALL TIMES! Kit features a top quality solder-masked and silk-screened PC board and first run parts and sockets. Any number of EPROM locations may be disabled to avoid any memory conflicts. Fully buffered and has WAIT STATE capabilities.



OUR 450 NS 2708'S ARE £4.25 ea + VAT WITH PURCHASE OF KIT ASSEMBLED AND FULLY TESTED

£55 + VAT

SAMS BOOKS AT MICRO PRICES

Computers and Programming Guide for Engineers	£8.75	IC Converter Cookbook	£9.45	Digital Electronics & 8080A Microcomputer Programming & Interfacing — Books 1 & 2	£14.95
TTL Cookbook	£6.45	Fundamentals of Digital Computers (2nd Ed.)	£6.75	Microcomputers for Business Applications	£5.95
CMOS Cookbook	£8.95	DEBUG: An 8080 Interpreter	£3.50	BASIC Primer	£5.95
Microcomputer Primer	£5.45	Debugger	£3.50	The S-100 and Other Micro Buses	£3.95
IC Timer Cookbook	£6.75	Microcomputer-Analog Converter Software & Hardware Interfacing	£6.45	Z-80 Microprocessor Programming & Interfacing — Book 1	£9.45
IC OP AMP Cookbook	£6.75	Microcomputer-Analog Converter Software & Hardware Interfacing	£6.45	Microcomputer Interfacing with the 8255 PPI Chip	£9.45
The 8080A Bugbook Microcomputer Interfacing & Programming	£7.25	Microcomputer-Analog Converter Software & Hardware Interfacing — Book 1	£6.45	Z-80 Microprocessor Programming & Interfacing — Book 2	£9.45
How to Programme Micro-computers	£5.95	Microcomputer-Analog Converter Software & Hardware Interfacing — Book 2	£7.45	8080/8085 Software Design — Book 2	£8.75
Getting Acquainted with Microcomputers	£5.95	Microcomputer-Analog Converter Software & Hardware Interfacing — Book 2	£7.45	8080/8085 Software Design — Book 2	£8.75
The Z-80 Microcomputer Handbook	£5.95	Microcomputer-Analog Converter Software & Hardware Interfacing — Book 2	£7.45	Electronic Telephone Projects	£6.45
Using the 6800 Micro-processor	£4.75	Microcomputer-Analog Converter Software & Hardware Interfacing — Book 2	£7.45		
The Cheap Video Cookbook	£3.95	Microcomputer-Analog Converter Software & Hardware Interfacing — Book 2	£7.45		

NEW! G.I. COMPUTER SOUND CHIP

AY3-8910. As featured in July, 1979 BYTE! A fantastically powerful Sound & Music Generator. Perfect for use with any 8 Bit Microprocessor. Contains: 3 Tone Channels, Noise Generator, 3 Channels of Amplitude Control, 16 Bit Envelope Period Control, 2-8 Bit Paralle I/O, 3 D to A Converters, plus much more! All in one 40 Pin DIP Super easy to interface to the S-100 or other busses. **SPECIAL OFFER: £8.25 + VAT each.** Add £2.25 for 64 page Data Manual

Ordering information: Postage free on orders over £10 otherwise add 25p. Add 15% to total.

MICROBYTE

UNIT 9-10, 1st FLOOR E BLOCK
38 MOULT PLEASANT LONDON WC1X 0AD.

Telephone 01-278 7369
Telex 895 3084

'Tiny' Pascal FOR TRS-80
Now you too can have Pascal! The famous Chung/Yuen 'tiny' Pascal has been specially designed for the TRS-80! The full power and elegance of 'tiny' Pascal is at your command. Programs written in 'tiny' Pascal run at least 4 times faster than the same program in BASIC! 'Tiny' Pascal is also a great way to learn Pascal programming, & fun too.

Best of all, you only need a 16K Level II TRS-80! No disk is required. The 'tiny' Pascal operating system is self-contained and very easy to use.

'Tiny' Pascal is a subset of standard Pascal & includes: RECURSIVE PROCEDURE/FUNCTION, IF-THEN-ELSE, REPEAT/UNTIL, PEEK & POKE, WHILE DO, CASE, MORE! (Plus full graphics for your TRS-80).

You can save and load programs to and from tape in both source and compiled form. You get all this and more, plus a user's manual for £29.95 + VAT. **DISK VERSION NOW AVAILABLE £39.95 + VAT.**

Anglophone

At last you can take complete advantage of your TRS-80 voice synthesizer. Forget about cumbersome phonetic codes. With 'Anglophone' you can simply use ordinary English. Completely interfaces with BASIC, or just about any other programming language. 'Anglophone' applies sophisticated pronunciation rules to transform normal English spelling into speech using the TRS-80 Voice Synthesizer. Minimum hardware: Level II, 16K, Voice Synthesizer. Comes complete with user's manual and test program. £39.95 + VAT.

Talking Terminal

The 'Talking Terminal' program turns a TRS-80 into a talking computer terminal. The 'Talking Terminal' program receives input from a remote computer and converts it to spoken words. Its many user options include: Instant Replay, spelled speech, silent or pronounced punctuation and more. Minimum hardware: Level II, 16K, Voice Synthesizer, RS-232c board and expansion interface. £125 + VAT.

MICROCHIPS AT MICRO PRICES

All devices are brand new, factory prime and full spec.

75322	£2.50	75324	£3.25	
75325	£3.25	75326	£3.25	
75361	£2.50	75362	£2.50	
75363	£3.50	75364	£2.95	
75365	£2.95	75451	50p	
2102 LHPC	High performance 250NS	0.99	74491/2	75p
2114	low power 300 NS	£2.95	8126	£1.75
2114	low power 250 NS	£3.25	8128	£1.75
4118	low power 250 NS	£18.95	8129	£1.75
4116	200 NS Ceramic	£3.50	8195	£1.75
2708	450 NS Ceramic	£4.50	8197	£1.75
2716	(Intel Type) Single 5V	£13.95		

NEW

4315 45L	4K CMOS RAM	£6.00
2532	low power 450 NS	£12.95
2532	32K Eprom	£39.95

NEW SYSTEMS

Z8001	16 Bit CPU w/ segmented address space to 8 Megabytes	£125.00
Z8002	16 Bit CPU with non segmented address space to 64K bytes	£96.00

Z8000DM

A single board micro computer that interfaces directly to any Zilog micro system. It contains a Z8002 CPU, 16K words of Dynamic RAM, a dual channel serial I/O port, 32 parallel I/O lines and a wire wrap user area.

WD9000B	The Pascal Micro engine chip set. A set of 5 chips including the 16 bit CPU which will directly execute Pascal generated P code — Revision 2.01. The only CPU in the market designed to directly execute a high level language at speeds five times faster than most typical computer systems	£199.00
WD909A	Single board micro computer containing WD9000 chip set, 64K bits (32K words) and single sided 8 inch disk drive	£1495.00

CPU's

6402	£7.95
6504	£7.95
6505	£7.95
6800	£8.95
6802	£8.95
8080A	£4.75
8085A	£10.95
Z80	£7.95
Z80A	£9.95
Z8001	£125.00
Z8002	£95.00
WD9000	£199.00

INTERFACE IC's

DM8123	£1.25
75150	£1.25
75154	£1.25
75182	£1.95

Z-80 PROGRAMMING MANUAL

By MOSTEK, or ZILOG. The most detailed explanation ever on the working of the Z-80 CPU CHIPS. At least one full page on each of the 158 Z-80 instructions. A must reference manual for any user of the Z-80. 300 pages.

Only £9.95

OSI SYSTEMS



Norlett House
Dormer Road
Thame
Oxon OX9 3UC
Telephone Thame
(084421) 5020 (24 hr)

YOUR COMPLETE OHIO SCIENTIFIC SERVICE

HERE ARE FIVE VERY GOOD REASONS FOR CALLING US —

1. O.S.I. SYSTEMS

— including the popular SUPERBOARD II and CHALLENGER 4P as either cassette or disc based systems.

2. O.S.I. SOFTWARE

— cassette and disk based software covering a broad spectrum of uses. Some of the cassette based software can also be run on the U.K.101.

3. BEAVER SOFTWARE

— Business, educational and entertainment software — professional programs with full listings and documentation. Also available for other systems — especially the U.K.101.

4. BEAVER PROGRAMMING AIDS

— including Video Workpads, BASIC workpads, Machine Code Workpads, Cassette Index cards and labels and Blank Cassettes, all available for OSI, U.K.101, and TRS-80.

5. DEMONSTRATIONS

— we will demonstrate in your own home or business premises (within a fifty mile radius of OXFORD, any or all of the systems and software available.

CALL OR WRITE ... NOW!

• Circle No. 284

**JPS for electronics TTL standard & LS CMOS
JPS linear microprocessor ICs semiconductor
resistor capacitors Vero & Eagle products etc**

THANDAR Instruments
by Sinclair Electronics
SC110 Scope 10 Mhz

10Mv/div £159.85
DM235 3 1/2 digit £60.38
DM350 3 1/2 digit £83.38
DM450 4 1/2 digit £113.85
PDM35 3 1/2 digit £39.68
full range of
accessories large
s.a.e. for more details

NASCOM-1

(a) with Nas-Sys1 & 4K
less PIO £143.75

NASCOM-2

(a) less PIO & Basic ROM
£205.56 Built £263.06

(b) standard form
1KVRAM 1KVRAM
£258.75

(c) as (b) + 8K static Ram
£350.75 Built £408.25

16,32 or 48K RAM
option available 3amp
power supply £33.93
full range of expansion
accessories large
s.a.e. for more details

Lists 20p + large s.a.e. VAT inclusive prices.

Add 75p PP on orders under £10 send to
JPS Dept PC 9 East St., Colne, Huntingdon, Cambs.

A selection from our
range of Components

Panel meters fsd 10ma
2 1/4 x 2 1/4 inches £2.50
3819 FET 23p

Led watch modules
4 for £2.00

Standard connectors
plug & sock 18 way
or 12 way £1.00 pair
4way 70p 2way 60p
Calculator PCBs
complete untested
3 for £3.20

Ten turn pots 50K
£2.00 Counterdial
for same £1.50

Relay 12v 4 pole CO
about 5amp 80p

Mini wafer switch
2pole 6way 40p
6p2w shorting 30p

1p3w 30p
723 regs 50p

Multipole connector
sub min plug & sock
15way £1.00
20way £1.00

• Circle No. 285

RICOH A printer for all systems

THE RP-40

This printer has a well established record of use in large systems throughout the country. Over a period of several years, it has earned an outstanding reputation for its exceptional quality and reliability.

THE RP-1600

The new RP-1600 is one of the most advanced daisywheel printers on the world market. It has been developed to meet both present and future needs of word processors, computer terminals and mini-computer systems. The unique double wheel, with its 124 character set, is the key to its superb performance. It allows an impressive speed of 60 characters per second and maintains excellent print quality.

APPLICATIONS

Ricoh printers are versatile. They are equally well suited to printing continuous large volumes of data, and to producing top quality word processed letters.

Microprocessor control of carriage movements down to 1/120 inch make them capable of bidirectional printing, proportional spacing, graph plotting, etc.

Through our selection of interfaces they can be connected directly to RS-232, Centronics, IEEE, etc — which means almost any small computers.

And they cost from as little as £1450.

We will be pleased to send you a sample printout and further details of the range of options available, and to quote for the printer to suit your own requirements.

For further details of the full range of Ricoh printers, please contact; —

Don Cooper
MICROPUTE
FREEPOST
MACCLESFIELD
CHESHIRE
SK10 1YE
Tel: 0625-612759

Mike Collier
BASIC COMPUTING
OAKWORTH ROAD
KEIGHLEY
WEST YORKSHIRE
BD22 7LA
Tel: 0535-65094

• Circle No. 286
PRACTICAL COMPUTING July 1980

WHY BUY A MICRO-COMPUTER FROM

PETALECT ELECTRONIC SERVICING LTD.

BECAUSE

- 1) Established company trading since 1971
- 2) Electronic servicing is our speciality
- 3) We have in-house programmers/systems analysts
- 4) We have our own service engineers
- 5) We will demonstrate the PET at your premises
- 6) We can customise the PET to your requirements
- 7) We can arrange finance
- 8) We offer, after the three-month warranty, a service contract from £69.50
- 9) You benefit from our experience of having sold over 450 micro-computers to industrial, educational and business, personal users.
- 10) We specialise in programs and interfaces for weighing applications for average weight control and counting etc.



All 'PETS' sold with a Basic Tutorial Tape

£47.00 + VAT
8K £550.00 + VAT
16K £675.00 + VAT
32K £795.00 + VAT

New Large
Keyboard 'PETS'
Now in Stock

In our showroom we sell
Books, Programs, etc.

Also available:

24K Memory Expansion Boards (disk-compatible), only £320 + VAT
PET-compatible : dual floppy disk unit with advanced operating system, only £840 + VAT
Large Extension Keyboard for the PET £89.50 + VAT
Telephone for complete system prices : Wide Range of Printers Available

If you require any more information or demonstration regarding the PET 2001/8 or any associated equipment, programs, etc., please contact our Marketing Department.

All correspondence to Portugal Road.

PETALECT ELECTRONIC SERVICES LTD
33/35 Portugal Road,
Woking,
Surrey.
Tel. Woking 69032/68497

Shop at:
PETALECT
Chertsey Road,
Woking,
Surrey.
Tel. Woking 21776/23637

• Circle No. 287

**MAIL ORDER
from Intex**

**SERVICE
FOR YOU!**

MAIL ORDER DEPARTMENT.
CASH WITH ORDER ONLY
OFFICIAL ORDERS ACCEPTED
FROM SCHOOLS, COLLEGES AND
GOVERNMENT OFFICES
ALL GOODS DESPATCHED BY RETURN
OF POST
OR YOU WILL BE NOTIFIED OF ANY DELAY
AND OFFERED AN ALTERNATIVE OR THE
RETURN OF YOUR MONEY.

PET		DEMAGNETISERS	
2001-8	495.00	CURVED HEAD(MAINS)	3.50
3016	675.00	CASSETTE (BATTERY)	12.00
3032	795.00		
C2N CASSETTE DECK	55.00	WORKBOOKS	
IEEE TO IEEE LEAD	25.00	TIS WORKBOOKS (NO VAT)	
P/ET TO IEEE LEAD	20.00	SET OF 6	18.00
3040 DISK	795.00		
COMPUTHINK 400K FOR		CONNECTORS	
8K VIA EXP/PET	825.00	PET USER/IEEE PORT	1.25
FOR 16/32K	895.00	PET 2ND CASS PORT	.95
800K UNIT	1145.00	COVERS FOR USER/IEEE	
24K EXPANDAPET	320.00	PORT CONNECTOR	2.50
		D52 RS232 CONNECTORS	
INTERFACES		MALE/FEMALE	3.25
SMALL SYS SERIAL C	120.00	COVERS	2.50
SERIAL B BI-DIR	185.00		
TNW2000 BI-DIR	145.00	KIM	
ALL IEEE/RS232		KIM 1	99.95
PETSET 1 A/D	165.00	KIM 3B	99.95
STOCKISTS OF PETSOFT &		KIM 4	69.95
APPLESOFT PACKAGES.			
COMMODORE SOFTWARE		NASCOM	
PAPER		NASCOM 1 (KIT)	125.00
TCM100 ROLLS	2.50	NASCOM 1 (BUILT)	140.00
ANADIX/PET 80 COL	15.00	NASCOM 2 (KIT)	295.00
TELETYPE 132 COL		POWER SUPPLY (KIT)	29.50
CASSETTES			
C15 HIGHGRADE CASS IN		<i>SEND FOR OUR FULL</i>	
CASES PER 10	4.00	<i>SOFTWARE & MAIL ORDER</i>	
		<i>PRICE LIST -</i>	
DISKETTES		CUST COVERS	
PET/APPLE D/DENS		PET (ALL MODELS)	5.75
PER 10 IN LIB. CASE	30.00	PET 3040	3.50
BASF D/S/D/D		COMPUTHINK DISK	3.00
PER 10 IN CASE	35.00	ANADIX DP8000	3.50
		T/T 43 PRINTER	5.75

ALL PRICES ARE EX.VAT.
PLEASE ADD 75P P&P ON SMALL ITEMS
2.50 ON LARGER ITEMS



Don't delay
SEND
NOW!



Name _____

Address _____ PC

Please send me _____ at £ _____

for the _____ system

Please send me your catalogue (tick)

Total £ _____ Signature _____

BARCLAY CARD ACCESS CHEQUE (tick)

Credit Card No. _____

INTEX DATALOG LTD., Eaglescliffe Industrial
Estate, Eaglescliffe, Stockton. Tel. 781193

Intex

• Circle No. 288

dysan

**Dysan
Diskettes**



Consistently the best you can buy.

Dysan diskettes are literally the best you can buy. Month to month, year to year you can rely on only the best quality.

- APPROVED BY LEADING DRIVE MAKERS
- FULLY ON AND OFF TRACK MODULATION TESTED
- CERTIFIED 100% ERROR FREE
- SINGLE & DOUBLE DENSITY
- SINGLE & DOUBLE SIDED

Tell us which computer or word processor you have and we'll tell you which diskette you need.



**COMPUTERS
LIMITED**

133 Woodham Lane New Haw
Weybridge Surrey KT15 3NJ
Tel: 0932 48346/7
Telex: 8813487

• Circle No. 289

ROUTE 66

COMPUTERS (MAIL ORDER)

**COMPUCOLOR II.
VIDEO GENIE. EG.3003**

ONLY £425 INC. VAT

**NASCOM INFORMEX PRINTERS
MICROSPEECH**

OTHERS AVAILABLE.
SOFTWARE AT REDUCED PRICES
THIS OFFER CAN NOT LAST FOREVER

Phone our computer dept. Today, or send
cheque to the Address below.

ACCESS ... BARCLAYCARD ... WELCOME
We can also offer Hirepurchase with No Deposit terms

127 NEW CROSS ROAD LONDON SE14 5DJ
Telephone 01-732 8608

• Circle No. 290

Floppy Disk Systems AT LOW COST

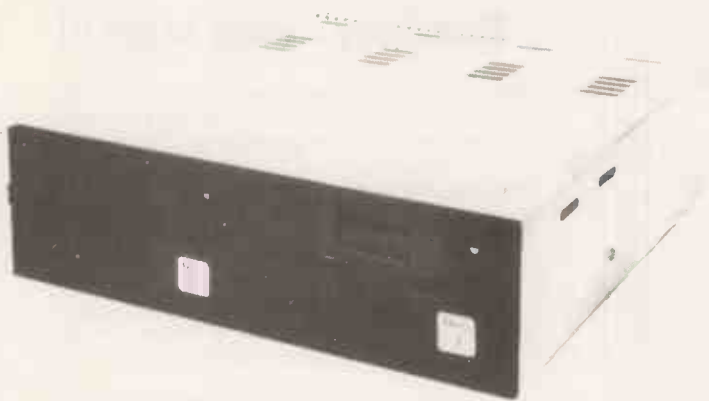

FOR THE APPLE® II and ITT® 2020

- * Mains Powered Dual Disk Unit.
- * 2 Disks Each Giving 116K Bytes.
- * Completely compatible with Apple® II and ITT® 2020 Disk controller cards.

Height: 92 mm Width: 149 mm
Length: 300 mm Weight: 7.8 Kg.

DUAL DISK UNIT £498

FOR THE TRS80, SWTP, SUPERBRAIN,
NORTH STAR HORIZON, HEATHKIT ETC. ETC.

40 Track single disk unit	£236
77 Track single disk unit	£345
40 Track Dual disk unit	£440
77 Track Dual disk unit	£645

- * Mains powered disk systems
- * Shugart SA400 Interface compatibility
- * Daisy chain up to four drives

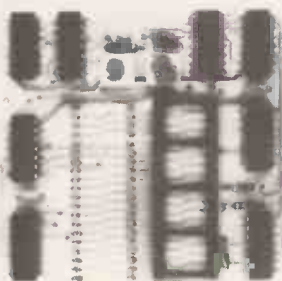
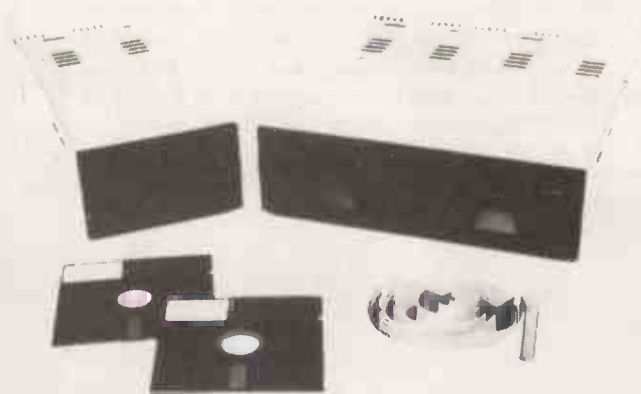

FOR TRS80 USERS

The PERCOM DATA SEPARATOR eliminates read and verify errors on the inner (higher numbered) tracks of your Disk Systems, Plugs into the expansion interface. No soldering – takes 5 minutes to fit.

£20 WITH FULL INSTALLATION INSTRUCTIONS

TRS80 DISK CABLES:	2 Drive Cable	£22.50
	4 Drive Cable	£34.00

Call your nearest dealer for a demonstration:

London Computer Store, 43, Grafton Way, London W1. Tel: 01-388-5721

Katanna Management Services, 22 Roughtons, Galleywood, Chelmsford, Essex. Tel: 0245-76127

Sevet Trading, 14, St. Paul's Street, Bristol 2. Tel: 0272-697757

EWL Computers Ltd., 8, Royal Crescent, Glasgow Tel: 041-332-7642

Data Plus Computer Services, 67, Bridge Street, Manchester. Tel: 061-832 3265

CUMANA LTD., 35, Walnut Tree Close, Guildford,
Surrey. GU1 4UN.
Tel: (0483) 503121
Telex: 859680 (Input G)

*Please add VAT to all prices.
Delivery at cost will be advised
at time of order.*

Tycho

Tycho Business Systems Ltd

TAILORED BUSINESS SYSTEMS to suit your business and pocket

BY combining the talents of programmers and accountants, TYCHO offers CP/M compatible business systems designed and written in Britain, adaptable to your requirements and complying with V.A.T. and P.A.Y.E./N.I. requirements.

OUR commercial suites include programs for
Invoicing/Inventory/Sales Ledger/Cash Received
Purchases/Expenses/Creditors Ledger/Cash Paid
Payroll/P.60s./P.35 General Ledger

ALL of these are available individually or as integrated systems.

SPECIALIST systems available include
Incomplete records and Accounts production
Asset registers and Summaries
Membership and Mailing Programs
'Magic Wand' The word processor that calculates

TYCHO can supply everything for the small business
Hardware Programs Knowledge Support

For further details contact **Bob Sarah F.B.C.S.**
Beechwood, Riseley, Reading RG7 1YA (073 583) 337
London Office: 1-9 Hills Place W.1.
01-734 4711

• Circle No. 292



Somebody's going to get it!

Your business is not exactly the same as any other and neither are its problems. Any solutions are probably unique and must be tailored exactly for you.

You know your business better than anyone else and any system designed should use your knowledge. The micro-computer specialist should show you how to use the computer to meet your business requirements.

You should be able to get the micro-computer which best suits your business. It should be chosen after your requirements are specified.

You and your staff have a right to know all about YOUR system, including helping to program it if you want. Training is your right — not an additional service.

If microcomputers cannot satisfy your business needs, you want to know — you don't want false promises.

67 Nova Road, Croydon, Surrey CR0 2TN.
Telephone: 01-688 6013

MIKE ROSE MICROS

• Circle No. 293

printed continuous stationery

we can supply Printed Continuous Forms
with your Company Name & Logo

also

ex-stock single-part listing paper
11 x 8½, 11 x 9½, 11 x 10¾, 12 x 8½, 11 x 9½
Multiples, OTC and NCR.

for prices and details phone:-

David Richards 01-520 8624

David Richards (Printers & Distributors) Ltd. 61/63 Hoe Street London E17 4SA

• Circle No. 294

SUPERBRAIN + CP/M = SOLUTIONS

THE INTERTEC DATA SYSTEMS SUPERBRAIN TOGETHER WITH THE WIDE RANGE OF AVAILABLE CP/M SOFTWARE OFFERS SOLUTIONS TO MANY INDUSTRIAL, COMMERCIAL & EDUCATIONAL PROBLEMS

**THE ONLY INTEGRATED
DESK TOP
MICRO IN
ITS PRICE
RANGE**



UNRIVALLED PRICE/PERFORMANCE STD FEATURES:-

- * 64K RAM * CPM 2.2 OPERATING SYSTEM
- * DUAL FLOPPY DISCS — 320 KB
- * DUAL Z-80 PROCESSORS
- * DUAL COMMUNICATION PORTS
- * FULL 80 COLUMN SCREEN

£1950 + VAT Full 6 month warranty

LEASE £73 P.M. OVER 3YRS — RENT £40 P.W.

OPTIONS

- * 600 KB DISCS £500 (May '80)
- * 1.6 MB DISCS £850 (June '80)
- * S-100 BUS ADAPTOR £250 (June '80)
- * PRESTEL (subject PO approval) £550 (July '80)

SERVICE

MODULAR CONSTRUCTION GIVES HIGH RELIABILITY
SIMPLE SERVICING — NATIONWIDE
SERVICE CONTRACT £260 PA

DEALERS

TERODEC (MICROSYSTEMS) LTD
BOYD MICROSYSTEMS LTD
M.A.P. COMPUTERS LTD
MICRO MANAGEMENT LTD
PICOBYTE LTD
SYSTEM MICROS LTD

Camberley, Surrey (0252) 874 790
Bushley Heath, Herts (01) 950 0303
Oldham, Lancs (061) 633 3084
Frinton-on-Sea, Essex (02556) 4592
Birmingham (021) 328 4840
Telford, Staffs (0952) 460 214

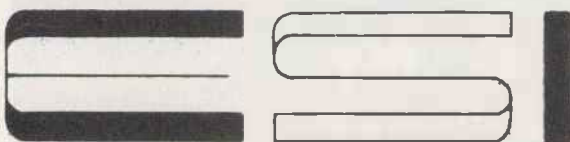

Showroom at Croydon, Surrey Telephone: Upper Warlingham 5701 Telex: 896559

ATTRACTIVE OEM, EDUCATIONAL & DEALER DISCOUNTS AVAILABLE

SOLUTIONS FOR BUSINESS:

- * GENERAL ACCOUNTING
- * STOCK CONTROL
- * ORDER ENTRY & INVOICING
- * PAYROLL
- * WORD PROCESSING

SOLUTIONS FOR SOFTWARE DEVELOPMENT

- * PASCAL, FORTRAN, COBOL, BASIC, ALGOL-60, LISP, APL, PL/1, 8080/Z80, 8086 ASSEMBLER

SOLUTIONS FOR OFF LINE DATA PREP

- * IBM 3780/2780 EMULATION
- * DEC, ICL & MOST MINI'S & MAINFRAMES

SOLUTIONS FOR INDUSTRY

- * LOW COST AUTOMATION
- * PROCESS CONTROL
- * DATA COLLECTION

SOFTWARE AVAILABLE FOR DEMONSTRATION AT OUR SHOWROOMS

BYSINC — 80 IBM 2780/3780/3270 EMULATION	
1st Installation	£500.00
Subsequent Installations	£250.00
Micro Data Base System (Codasyl)	£450.00
Selector III Information Management System	£195.00
Wordstar	£275.00
Mailshot/Merge	£ 75.00
Osbourne & Associates General Ledger	£200.00
Accounts receivable/Accounts Payable	£200.00
Regis Stock Control	£475.00

WE ARE NOW SOLE DISTRIBUTORS ON SUPERBRAINS FOR GRAHAM-DORIAN SOFTWARE SYSTEMS EUROPE

1. Sales Ledger	£500	2. Purchase Ledger	£500
3. Nominal Ledger	£500	4. Payroll	£500
5. Job Costing	£500	6. Order Entry/Invoicing	£500
7. Inventory	£300	8. Cash Register	£300
9. Point of Sale	£300	10. Wholesale Inventory	£300
11. Manufacturing	£500	12. Dental (Aug' 80)	£500
13. Apartment Management (Aug' 80)	£300		
All Software Requires CBASIC	£ 85		

ALSO AVAILABLE

ESL — 80 MATRIX PRINTER

- * RS-232, Current Loop IEEE & Centronics IO Allows Connection to PET, TRS-80, Apple etc.
 - * 60 Lines/Minute * 64-132 Chars/Line * Up to 19,200 Baud
 - * Friction or Tractor Feed * Up to 9 1/2" Paper * Incredible Range of Software controlled features including graphics and user defined characters
- SPECIAL OFFER £395.00 + VAT INCLUDING 2K BUFFER

Encotel Systems Ltd

**Give
a computer
the wrong
conditions and
it will withdraw
its labour.**



Computers need the controlled environment that only air conditioning can supply. Talk to the specialists in Computer Room air conditioning, Discon.

We use Carlyle equipment, the biggest seller in the world; renowned for reliability. For a complete 'Turnkey' operation — Design, Installation and Maintenance, look to Discon.

Discon Air Conditioning Ltd



146 Main Road, Biggin Hill, Kent.
Tel: Biggin Hill 71751/2/3



the air conditioning leader

• Circle No. 296

**Apple extras
that won't break
the bank!**

Talk to Apple VOICE
RECOGNITION CARD
4 Demo Programs. Manual
Quality Microphone.
Full Guarantee.
£99

TRS80 LEVEL 1
Complete one off
as new.
£250

**MICROPRODUCTS
PARALLEL CARD**
A low cost parallel card.
£25

**SUPER SOUND
GENERATOR Like ALF**
but half the price.
Complete musical
tutor — quite
sensational.
£90

**SPARE DISK
CONTROLLER CARDS**
£35

**SPARE GAMES
PADDLES**
£10

**CENTRONICS
779 PAPER
STACKERS**
£5

PRINTERS Axiom 801
For Apple II or PET an excellent
listing printer.
80/40/20 column. 96 characters.
120 lines per minute.
Parallel ASCII. Reverse printing.
2K Buffer. 2K User Prom Memory.
Software Select 3 character sizes.
2 FREE ROLLS OF PAPER.
FREE INTERFACE.
£220

These special prices
for a limited period only.
Phone 01 626 8121 between 9.30 a.m. and 5.30 p.m.,
Monday to Friday, to avoid disappointment.

All prices excluding VAT

Personal Computers Ltd.

194-200 Bishopsgate, London EC2M 4NR. Tel: 01 626 8121 Telex: 888264

• Circle No. 297

SALE

Ideal opportunity for small businesses, educational establishments and personal users to buy hardware at fantastically low prices.

Due to reorganisation we have well-known brands of micro systems, printers, peripherals, computer games, memory boards etc which must be cleared off our shelves.

BUY NOW....

Daisy wheel printers, plus stand and accessories for only £1,000!

Disc drives - brand new and boxed - half price!

Get the details now from

**the BYTE SHOP
COMPUTERLAND**
- your specialist Computerstore.

London

48 Tottenham Court Road
London W1R5 4TD
Tel: 01-636 0647

Glasgow

Magnet House
Waterloo Street
Glasgow Tel: 041-221 7409
Telex: 779263

Birmingham

94-96 Hurst Street
Birmingham B5 4TD
Tel: 021-622 7149 Telex: 336186

Nottingham

92a Upper Parliament Street
Nottingham NG1 6LF
Tel: 0602 40576 Telex: 377389

Manchester

11 Gateway House
Piccadilly Station Approach
Manchester
Tel: 061-236 4737 Telex: 666168

• Circle No. 298

LEARNING TO BE PATIENT ISN'T PART OF THE SYLLABUS.

Compared with other educational computers, our Tandberg EC10 is mastermind.

It's the one that can handle up to 7 VDU's.

So if you include the master keyboard, the 'mind' of our computer can teach up to 8 pupils at a time. Individually.

That way your pupils learn extended basic computer language quicker.

And patience becomes something they learn about elsewhere.

The Tandberg EC10 is masterful in other ways too.

That's because it's the brainchild of a company that specialises in educational computers.

So its not a sawn-off version of somebody else's small business system, dependent on slow cassettes for program storage.

This means it runs as quietly as a well-ordered class; is as physically neat as a school-boy on his first day; and no education committee's going to query it's running costs.

The capability of the EC10 extends to commercial Basic and Cobol languages, printer

interface and V24 interface for other mainframe computers.

Moreover it can be programmed to handle educational administration.

By now we hope you're impatient for further information.

So send off the coupon and we promise we won't keep you waiting either.

To: Tandberg Ltd, 81 Kirkstall Road, Leeds LS3 1HR.
"PLEASE DESPATCH EXPANDED DATA"

ENTER

Name _____

PC7

Address _____

Postcode _____

SELECT

School

College

Local Authority

TANDBERG
Education Division

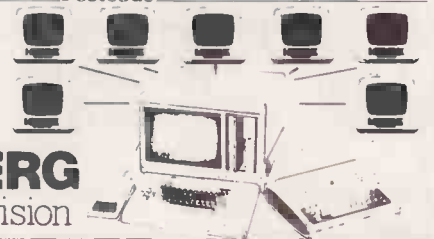

LEENSHIRE LTD

Specialist British Designers and Manufacturers of Mini and Micro Computer Systems and Visual Display Units for Industrial and Commercial applications.

We supply Control Visual Display Systems for the Utility Authorities, Airports, Plastic, Paper and Engineering Industries, Banks and Communication Networks.

Can we help you with your Computer/System or S100 requirements?

Leenshire Ltd.,
13 Cathedral View,
Winchester,
Hants.

• Circle No. 300

New SS50 BUS RANGE

Mini MK 3 two card computer system with S50 bus pin outs: has 300B CUTS, 2000 Baud high speed tape, full QWERTY keyboard, VDU with u/l case and optional graphics, Mikbug type monitor, expandable to full business system £155.00

S50 16K-32K Dynamic RAM kit. Single S50 slot, low power, invisible refresh. 16K £130.00 32K £200.00

6800/9S Single Board Kit. Single card version of MINI but includes 16K of user RAM and power supply components with prov for printer interface £299 with keyboard.

Full range of add-ons for these kits is available.

WE ARE OFFICIAL APPLE DEALERS.
Apple 16K b&w now £750.00

We can customise and develop APPLES and our own 6800 systems to suit your needs.

HEWART MICROELECTRONICS
95 Blakelow Road,
Macclesfield, Cheshire.
Tel: 0625 22030



• Circle No. 301

Information is power...

...but disorganised data and jumbles of paper mean that your business is running at less than its best.

Database Management Systems bring those information problems under control.

We specialise in small database management systems — and small refers to the cost, not the performance, with machines capable of handling up to 300Mbytes of hard-disc storage with full network abilities. That's more than 100,000 text pages instantly retrievable from any of up to sixteen terminals — the electronic filing cabinet!

Ohio Scientific systems combine this with computing abilities that are better than most — better and simpler expansion, faster operation, lower overall cost. Complete database systems start at about £2500; hard-disc systems from £6500 (excl. VAT). For *real* computing — large databases, industrial control and data acquisition, high speed processing — and solutions that won't break your budget, Ohio Scientific from Mutek is your first choice.

Experience counts... Ohio Scientific are the market leaders in database management computer systems, and all our staff have had plenty of experience in hardware and software aspects of the computer industry. We have used Ohio Scientific computer systems in a wide range of applications — let us show you how these superb systems can be used in your application.

We supply solutions... not just the hardware! Call us and talk to our engineers and programmers, for practical answers to your questions.

Mutek — real database management... for less than you expect

Mutek — the independent Ohio Scientific specialists — Quarry Hill, Box, Wilts. Tel: Bath (0225) 743289

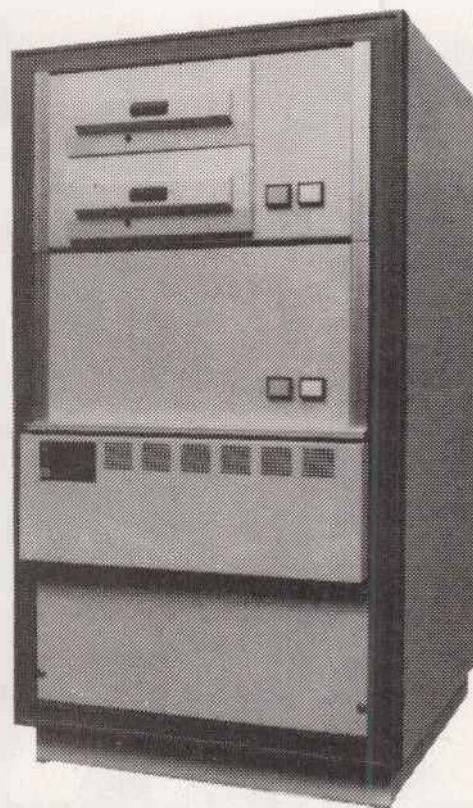

• Circle No. 302

PRACTICAL COMPUTING July 1980

COMPUTECH for apple

COMPUTECH for

Well proven software (several hundred packages already licensed) for business applications on the ITT 2020 and Apple microcomputers.

Prices excluding V.A.T for cash with order, F.O.B London NW3

PAYROLL	(300+ Employees, 100 Departments, hourly, weekly, monthly. Very powerful but easy to use).	£375
SALES LEDGER	(500+ Accounts, 100 Departments).	£295
PURCHASES LEDGER	(500+ Accounts, 100 Departments).	£295
GENERAL (OR NOMINAL) LEDGER	(1000 Accounts, 100 Analyses, multi-purpose package).	£295
UTILITIES DISK 1	(Diskette patch, slot to slot copy, zap etc).	£20
APPLEWRITER	(Word Processing)	£42
VISICALC	(Financial Modelling, Costing, Analysis)	£95

AND NOW HARDWARE!

COMPUTECH DIPLOMAT H/S SERIAL INTERFACE £80

This card has been designed and built to the same professional standards that have resulted in the success of our software. The DIPLOMAT observes the proper "handshaking" protocol so that you can drive fast printers and send and receive data from other peripherals at high speeds without loss of data. Switch (& software) selectable baud rates to 19200 and many other options. Plug compatible with 'terminal' or 'modem' wired peripherals. Guaranteed.

THE FABULOUS MICROMUX 8000 from £800

This is a brand new product, an asynchronous serial multiplexor with up to 16 ports, any one of which may communicate with any other independently, like a 'telephone exchange' for data! Built in test function. Firmware may be customised for special applications. Available in multiples of 4 ports up to 16.

COMPUTECH SYSTEMS

168, Finchley Road, London NW3 6HP. Tel: 01-794 0202

AGENTS THROUGHOUT THE UK AND OVERSEAS

DATA LINK

Microcomputer Systems Limited

Systems software for business, industrial and scientific applications

From the Micro City of the Future

image data

32K System with dual 5 1/4" disk drives, keyboard, VDU and printer **£2339.00**
As above with visual display terminal and daisy wheel printer **£4866.00**
Made in Bristol

APPLE/ITT 2020

Apple II Plus 16K (B&W) **£695**
ITT 2020 16K (Colour) **£778**
Disk Drive with Controller **£349**
Dual Headed Disk Drive 1/4 MB **£480**
16K Add-ons **£69**
Alf Music Synthesizer **£135**
CCS HS Serial Card **£113**
Comm. Card **£130**
ROM Plus Board **£110**
Clock Card **£152**

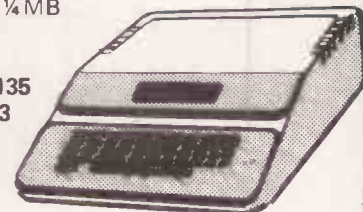

AUTHORISED APPLE SERVICE CENTRE

SOFTWARE

We have second to none programming facilities, both in-house and through an associated Company: Management Services and Systems Ltd. All our programs are original and fully guaranteed E.G.

Mailing List **£50** Stock Control **£200**
Integrated Accounts Package **£800** (Sales/Purchase/Nominal Ledgers/Invoicer)
Sales Management Package **£400**
Critical Path Analysis **POA** Contract Estimating **POA**
Programs are written for both the Apple and Image Data systems. They can be tailored to meet a customer's particular requirements.

PRINTERS

Centronics 730 **£525**
Centronics 737 (Five Euro Language Ch. Sets) **£656**
Paper Tiger (with graphics) **£598**
Qume Sprint 5 **£1845**
Microhush **£266**
Silentype **£349**

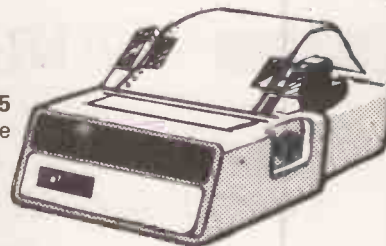

Systems Furniture

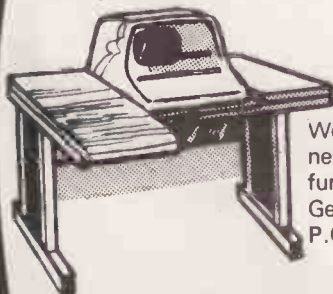

* STOP PRESS

We now have available an exciting new range of GESIKA systems furniture specially imported from Germany by BEAM P.O.A.

COMPUTER STATIONERY and ACCESSORIES

9" Plain Listing Paper (per 2000 sheets) **£16.00**
12.27/32" Listing Paper (per 2000 sheets) **£20.00**
Microhush Thermal Paper (2 rolls) **£4.00**
Customised Computer Stationery (Invoices/Statements/etc) P.O.A.
BASF 5 1/4" Diskettes **£2.50**
BASF 8" Diskettes **£3.00**
Library Cases for 5 1/4" **£2.64**
Library Cases for 8" **£3.50**
Diskette Tray with Lockable lid for 5 1/4" **£16.00**
Diskette Tray with Lockable lid for 8" **£22.00**
Dust Covers **£5.50**

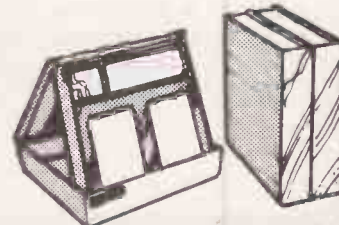

We also stock an extremely comprehensive range of computer books

DATA LINK

10 Waring House, Redcliffe Hill, Bristol BS16TB
Telephone: Bristol (0272) 213427

TANDY

TRS-80 MICROCOMPUTERS

FOR BUSINESS,
LEARNING AND
ENTERTAINMENT

TRS-80 MODEL I 4K LEVEL I TRS-80 MODEL I 16K LEVEL II

£385.25 £546.25

TRS-80 4K Level I System. Place a cassette in the player . . . type CLOAD and press the ENTER key . . . watch the screen for the READY indication . . . type RUN, press ENTER . . . what then? Depending on the cassette you could run Maths, English, Chess, Draughts & Video game programs for educational fun! And if you want to write your own programmes, the Level 1 "plain language" manual (included) makes it easy to learn. 26-1001.

TRS-80 16K Level II System. Business people and professionals by the thousands have discovered the capabilities of Level II. And TRS-80 ready-to-use software means you (or your staff) can put it to work immediately, with a minimum of training. Calculator-type keypad now included—yet the price is at an all time low. 26-1006.



NOW AVAILABLE

TRS-80/
MODEL I C.P.U.'s

- * Complete and ready to run from your own TV monitor
- * Includes C.P.U., Power Supply, UHF Modulator/connector, Instruction Manual, Game Cassette and connection lead for cassette player.

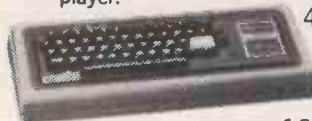

4K Level I C.P.U.
£289
Cat. No. 26-9051



16K Level II C.P.U.
With numeric
key pad
£439
Cat. No. 26-9056

CTR-80 Cassette Player — Specially adapted for use with TRS-80 Model I computer systems. 26-1205 **£41.95**

NEW

TRS-80 MODEL II MEANS BUSINESS



Designed to Meet the Needs of
Business and Administration
5 Figure Computing Power
at a 4 Figure Price

Orders being
taken for
Systems from **£1,999**
(PLUS V.A.T.)

DELIVERY 30-60 DAYS

Model II operates at twice the speed of our famous best selling Model I. In addition to its 32 or 64-thousand bytes of Random Access Memory, a built-in 8" floppy disc stores another half-million bytes. And modular design accepts additional disk drives for up to 2 million bytes of memory! Model II's 12" high-resolution video monitor displays 24 lines of 80 upper and lower case letters. The professional 76-key keyboard has special function keys and a calculator keypad. Model II systems include our enhanced Level III BASIC language, one of the most powerful computer languages today.

Visit your TANDY Computer Centre or any TANDY store for details on the TRS-80 Model II — the really low-cost microcomputer that's "strictly business".

All Prices inclusive of V.A.T.
except where stated.

Access, Barclaycard and
Trustcard welcome. Check your
telephone directory for your
nearest store.
Offers subject to availability.
**OVER 180 STORES &
DEALERSHIPS NATIONWIDE.**

TANDY

The Biggest Name in Little Computers



**TANDY
DEALER**

Most items also available at
Tandy Dealers. Look for this sign
in your area. Prices may vary at
Individual stores.

For Further Information
on TRS-80 Systems
contact

TRS-80 DIV. TANDY CORPORATION (Branch UK)
BILSTON ROAD, WEDNESBURY, WEST MIDLANDS WS10 7JN
Telephone 021-556 6101

•Circle No. 305

Software for most popular 8080/Z80 computer disk systems including NORTH STAR HORIZON, VECTOR MZ, OHIO SCIENTIFIC, CROMEMCO, PROCESSOR TECHNOLOGY, RAIR BLACK BOX, DYNABYTE, SD SYSTEMS, RESEARCH MACHINES, ALTAIR, EXIDY SORCERER, IMSAI, HEATH, and 8" IBM formats

- Software with Manual / Manual Alone
- MDBS** - Micro Data Base System. Full network data base with all features of HDBS plus multi-level Read/Write protection for FILE, SET, RECORD and ITEM. Accurate representation of one to one SET relationships. Supports multiple owner and multiple record types within SETs. HDBS files are fully compatible.
 - MOBS-DRS** - MDBS with Dynamic Restructuring System option which allows altering MDBS data bases when new ITEMS, RECORDS, or SETS are needed without changing existing data.
 - HDBS-Z80 version £135/£25
 - MDBS-Z80 version £395/£25
 - MOBS-DRS-Z80 version £455/£25
 - 8080 Version available at £45 extra
 - Z80 version requires 20K RAM. 8080 version requires 24K RAM. (Memory requirements are additional to CP/M and application program.)
 - When ordering HDBS or MDBS please specify if the version required is for 1) Microsoft L80 i.e. FORTRAN-80, COBOL-80, BASIC COMPILER, 2) MBSAC 4, XX, or 3) BASIC-80 5.0.
 - PASCAL/M** - Compiler generates P code from extended language implementation of standard PASCAL. Supports overlay structure through additional procedures and the SEGMENT procedure type. Provides convenient string handling capability with the added variable type STRING. Untyped files allow memory image I/O. Requires 56K CP/M. £195/£20
 - PASCAL/Z** - Z80 native code PASCAL compiler. Produces optimised portable reentrant code. All interfacing to CP/M is through the support library. The package includes compiler companion macro assembler and source for the library. Requires 56K and Z80 CPU. Version 2 includes all of Jensen/Wirth except variant records £155/£15
 - Version 3 Upgrade with variant records and strings expected 2/80 £205/£15
 - PASCAL/MT** - Subset of standard PASCAL. Generates ROMable 8080 machine code. Symbolic debugger included. Supports interrupt procedures, CP/M file I/O and assembly language interface. Real variables can be BCD, software floating point, or AMD 9511 hardware floating point. Version 3 includes Sets, Enumeration and Record data types. Manual explains BASIC to PASCAL conversion. Source for the run time package requires MAC I (See under Digital Research). Requires 32K. £135/£20
 - TINY C** - interactive interpretive system for teaching structured programming techniques. Manual includes full source listings £45/£30
 - BOS C COMPILER** - Supports most major features of language, including Structures, Arrays, Pointers, recursive function evaluation, linkable with library to 8080 binary output. Lacks data initialization, long & float type and static & register class specifiers. Documentation includes "C" Programming Language book by Kernighan & Ritchie £60/£10
 - WHITESMITH'S C COMPILER** - The ultimate in systems software tools. Produces faster code than Pascal with more extensive facilities. Conforms to the full UNIX Version 7 C language, described by Kernighan and Ritchie, and makes available over 75 functions for performing I/O, string manipulation and storage allocation. Compiler output in A-Natural source. Supplied with A-Natural. Requires 60K CP/M £325/£20
 - POLYVUE/80** - Full screen editor for any CRT with XY cursor positioning. Includes vertical and horizontal scrolling, interactive search and replace, automatic text wrap around for word processing, operations for manipulating blocks of text, and comprehensive 70 page manual £70/£12
 - POLYTEXT/80** - Text formatter for word processing applications. Justifies and paginates source text files. Will generate form letters with custom fields and conditional processing. Support for Daisy Wheel printers includes variable pitch justification and motion optimization. £45/£10
 - ALGOL 60 Compiler** - Powerful block-structured language featuring economical run time dynamic allocation of memory. Very compact (24K total RAM) system implementing almost all Algol 60 report features plus many powerful extensions including string handling, direct disk address I/O etc. Requires Z80 CPU £110/£12
 - Z80 Development Package** - Consists of (1) disk file line editor, with global inter and intra-line facilities; (2) Z80 relocating assembler, Zilog Mostek mnemonics, conditional assembly and cross reference table capabilities; (3) linking loader producing absolute Intel hex disk file for CP/M LOAD, DDT or SID facilities £50/£12
 - ZDT** - Z80 Debugger to trace, break and examine registers with standard Zilog/Mostek mnemonic disassembly displays. Facilities similar to DDT £20 when ordered with Z80 Development Package £30/£7
 - DISTEL** - Disk based disassembler to Intel 8080 or TDL/Xitan Z80 source code, listing and cross reference files. Intel or TDL Xitan pseudo ops optional. Runs on 8080. £35/£7
 - DISILOG** - As Distel to Zilog Mostek mnemonic files. Runs on Z80 only £35/£7
 - TEXTWRITER III** - Text formatter to justify and paginate letters and other documents. Special features include insertion of text during execution from other disk files or console, permitting recipe documents to be created from linked fragments on other files. Has facilities for sorted index, table of contents and footnote insertion. Ideal for contracts manuals, etc. £75/£3

- Software with Manual / Manual Alone
- POSTMASTER** - A comprehensive package for mail list maintenance that is completely menu driven. Features included keyed record extraction and label production. A form letter program is included which produces neat letters on single sheet or continuous forms. Compatible with NAD files. Requires CBASIC-2 £85/£10
 - XASM-68** - Non-macro cross assembler with nested conditionals and full range of pseudo operations. Assembles from standard Motorola MC6800 mnemonics to Intel hex £115/£15
 - XASM-65** - As XASM-68 for Processor Technology MCS-6500 series mnemonics £115/£15
 - WHATSI7?** - Interactive data-base system using associative tags to retrieve information by subject. Hashing and random access used for fast response. Requires CBASIC £70/£15
 - XYBASIC** Interactive Process Control BASIC - Full disk BASIC features plus unique commands to handle bytes, rotate and shift, and to test and set bits. Available in integer, Extended and ROMable versions.
 - Integer Disk or Integer ROMable £165/£15
 - Extended Disk or Extended ROMable £215/£15
 - SMAL/80** Structured Macro Assembly Language - Package of powerful general purpose text macro processor and SMAL structured language compiler. SMAL is an assembler language with IF-THEN-ELSE, LOOP-REPEAT-WHILE, DO-END, BEGIN-END constructs £40/£10
 - SELECTOR III-C2** - Data Base Processor to create and maintain multi Key data bases. Prints formatted, sorted reports with numerical summaries or mailing labels. Comes with sample applications including Sales Activity, Inventory, Payables, Receivables, Check Register, and Client/Patient Appointments, etc. Requires CBASIC Version 2. Supplied in source code. £185/£12
 - CPM/374X Utility Package** - has full range of functions to create or re-name an IBM 3741 volume, display directory information and edit the data set contents. Provides full file transfer facilities between 3741 volume data sets and CP/M files £125/£7
 - BASIC UTILITY DISK** - Consists of (1) CRUNCH-14 Compacting utility to reduce the size and increase the speed of programs in Microsoft Basic and TRS-80 Basic. (2) OPFUN - Double precision subroutines for computing nineteen transcendental functions including square root, natural log, log base 10, sin, arc sin, hyperbolic sin, hyperbolic arc sin, etc. Furnished in source on diskette and documentation £30/£10
 - THE STRING BIT** - Fortran character string handling. Routines to find, fill, pack, move, separate, concatenate and compare character strings. This package completely eliminates the problems associated with character string handling in FORTRAN. Supplied with source £30/£10
 - BSTAM** - Utility to link one computer to another also equipped with BSTAM. Allows file transfers at full data speed (no conversion to hex), with CRC block control check for very reliable error detection and automatic retry. We use it! It's great! Full wildcard expansions to send *.COM, etc. 9600 baud with wire, 300 baud with phone connection. Both ends need one. Standard and M versions can talk to one another £75/£5



Orders must specify disk type and format, e.g. North Star-Horizon single density.

Add VAT to orders for software (not manuals alone) Add 50p per item postage and packing (minimum £1)

All orders must be prepaid (except COD or credit card) Make cheques POs etc payable to Lifeboat Associates.

Manual costs are deductible from subsequent software purchase

Lifeboat Associates
32 Neal Street
London WC2H 9PS
01-379 7931

Modified version available for use with CP/M as implemented on Heath and TRS-80 Model 1 computers.

User license agreement for this product must be signed and returned to Lifeboat Associates before shipment may be made

*CP/M is a trademark of Digital Research
**Z80 is a trademark of Zilog Inc.

The Software Supermarket is a trademark of Lifeboat Associates.
EFFECTIVE MARCH 1980

July

- **1-4** **Digital image processing.** Venue: London. Provides comprehensive introduction to latest digital image-processing techniques. Fee: £470 + VAT. Contact: ICSP U.K. LTD, Pebblecombe, Tadworth, Surrey, KT20 7PA. Tel: (03723) 79211.
- **1-4** **Microprocessors and microcomputers.** Venue: London. Provides a broad foundation in microprocessor applications and hands-on training in the skills necessary to use microprocessors. Fee: £470 + VAT. Contact: ICSP U.K. Ltd, Pebblecombe, Tadworth, Surrey, KT20 7PA. Tel: (03723) 79211.
- **1-4** **Software/hardware project management.** Venue: London. Designed to develop and improve skills required to manage software/hardware projects successfully. Fee: £470 + VAT. Contact: ICSP U.K. Ltd, Pebblecombe, Tadworth, Surrey, KT20 7PA. Tel: (03723) 79211.
- **1-4** **Structured programming.** Venue: London. The course presents the practical and systematic tools and techniques of structured programming as applied to scientific and engineering applications. Fee: £470 + VAT. Contact: ICSP U.K. Ltd, Pebblecombe, Tadworth, Surrey, KT20 7PA. Tel: (03723) 79211.
- **2-4** **First steps in microprocessing.** Venue: Portsmouth Polytechnic. Introductory course, designed for engineers, with an emphasis on hands-on training. Fee: £85. Contact: Mrs A P Sizer, Department of Electrical and Electronic Engineering, Portsmouth Polytechnic, Anglesea Road, Portsmouth, PO1 3DJ. Tel: (0705) 27681 Extn. 30.
- **3-4 & 17-18** **Introduction to microprocessing.** Venue: Bedford. Introductory course on microprocessor using the TMS 9900 minimum system. Designed for engineers and technicians, non-technical, high-level language programmers, technical authors and instructors. Fee: £95 + VAT. Contact: Mike Hughes, Microprocessor Training Centre, Texas Instruments Ltd, Manton Lane, Bedford, MK1 7PA. Tel: (0234) 67466 Extn. 3718.
- **7-9** **Second steps in microprocessors.** Venue: Portsmouth. Follow-up course to First Steps, or for those with a knowledge of microprocessors and includes extensive hands-on training. Fee: £99. Contact: Mrs A P Sizer, Department of Electrical and Electronic Engineering, Portsmouth Polytechnic, Anglesea Road, Portsmouth PO1 3DJ. Tel: (0705) 27681 Extn. 30.
- **7-10** **Mirosoftware.** Venue: University of Sussex, Brighton. Techniques used in the implementation of software for microprocessor-based equipment will be reviewed and typical problems outlined, together with their possible solutions. Designed for engineering staff who are required to design and develop microprocessor-based equipment. Fee: £150 + VAT for non-members, members of SERT, IERE, or IEE, £125 + VAT. Contact: Janet Firmin, Society of Electronic and Radio Technicians, 57-61 Newington Causeway, London SE1 6BL. Tel: 01-403 2351.
- **7-11** **Program design: fundamentals workshop.** Venue: London. Designed for all levels of programming and systems development staff, including trainees, the course is concerned with the design, coding and implementation of programming projects. On completion, the participant will be able to use the basic skills of data-structured design to achieve reliable, simple and understandable programs. Fee: £495. Contact: The Registrar, Infotech, Nicholson House, Maidenhead, Berkshire. Tel: (0628) 39101.
- **8-11** **Digital filters and spectral analysis.** Venue: London. Provides participants with fundamentals of advanced processing techniques, software and hardware. Fee: £470 + VAT. Contact: ICSP U.K. Ltd, Pebblecombe, Tadworth, Surrey, KT20 7PA. Tel: (03723) 79211.
- **8-11** **Interactive computer graphics.** Venue: London. Details the advanced software techniques and hardware technology which have bought interactive computer graphics to practical levels of price and performance, and provides participants with a detailed knowledge of technological fundamentals. Fee: £470 + VAT. Contact: ICSP U.K. Ltd, Pebblecombe, Tadworth, Surrey, KT20 7PA. Tel: (03723) 79211.
- **9-11** **Microprocessor Pascal run-time support.** Venue: Bedford. For system designers, project engineers and programmers who can write single-process Pascal programs. Covers the use of the Texas Instruments Microprocessor Executive in the design and implementation of stand-alone, multi-processing systems. Fee: £250 + VAT. Contact: Mike Hughes, Microprocessor Training Centre, Texas Instruments Ltd, Manton Lane, Bedford MK1 7PA. Tel: (0234) 67466. Extn. 3718.
- **10-15** **Microprocessor system design.** Venue: Portsmouth. Deals with the development of a microprocessor-based product from conception through to the completed hardware. Fee: £150. Contact: Mrs A P Sizer, Department of Electrical and Electronic Engineering, Portsmouth Polytechnic, Anglesea Road, Portsmouth PO1 3DJ. Tel: (0705) 27681 Extn. 30.
- **11-12** **London Computer Fair.** Venue: Polytechnic of North London. Contact: Robin Bradbeer, The Polytechnic of North London, Holloway, London N7 8DB. Tel: 01-607 2789.
- **14-18** **Introduction to the design of microprocessor-based systems.** Venue: Cambridge. Designed to give the basic techniques necessary for the design of microprocessor-based systems; 40 percent of course time is given to lectures with 60 percent hands-on practical design work. Fee: £240 + VAT. Contact: Course Registrar, Cambridge Microcomputers Ltd, Cambridge Science Park, Milton Rd, Cambridge. Tel: (0223) 314666.
- **14-18** **Program Design: Advanced techniques workshop.** Venue: London. Includes advanced techniques of the data-structured-design method, and shows in detail how the method handles the special problems of on-line, real-time, and database systems. Fee: £495. Contact: The Registrar, Infotech, Nicholson House, Maidenhead, Berkshire. Tel: (0628) 39101.
- **14-18** **8085 course: part 1.** Venue: London. Designed for engineers, teaching the fundamentals of microprocessors, with particular stress on the Intel 8085. Fee: £200. Contact: Robin Bradbeer, The Polytechnic of North London, Department of Electronic and Communications Engineering, Holloway, London, N7 8DB. Tel: 01-607 2789.
- **15-17** **Computer-aided classroom instruction.** Venue: Salford University. The aim of the course is to show how desk-top microcomputers can be used to enable school children to explore problems in science, even if they have no knowledge of programming. Fee: £27. Contact: The Administrative Assistant, short courses, Room 110, Registrar's Department, University of Salford, Salford M5 4WT. Tel: 061-736 5843.

- **16** **Introduction to computers and their application.** Venue: Polytechnic of the South Bank, London. Designed to give an awareness of the potential for computer applications within the small company. Participants will have the opportunity to use mainframe and microcomputers in informal, small groups. Fee: Members £50 + VAT. Non-members £60 + VAT. Contact: Training Department, LCCI, 69 Cannon Street, London EC4N 5AB. Tel: 01-248 4444.
- **17-18** **16-bit microprocessors.** Venue: Portsmouth. Describes and contrasts, through lectures, demonstrations and hands-on sessions, the TMS9900, Z8000, M68000, M6809 and 8086 microprocessors. Fee: £95. Contact: Mrs A P Sizer, Department of Electronic and Electrical Engineering, Portsmouth Polytechnic, Anglesea Road, Portsmouth PO1 3DJ. Tel: (0705) 27681 Extn. 30.
- **19-20** **Programming in Basic course.** Venue: Hallam Tower Hotel, Sheffield. Designed for those who possess or are considering using a microcomputer or minicomputer in their business and wish to learn how to write programs using the Basic programming language. Fee: £115. Contact: Dean Consultancy Ltd, 45 Canterbury Avenue, Sheffield, S10 3RU. Tel: (0742) 303054.
- **22-24** **1980 Microcomputer Show.** Venue: Wembley Conference Centre, London. Fee: £1.50. Contact: Online Conferences Ltd, Argyle House, Joel Street, Northwood Hills, HA6 1TS, Middlesex. Tel: (09274) 28211.
- **23-25** **Assembly-language programming.** Venue: Bedford. Follows the course on introduction to microprocessors. Centred round the programming of the TM 990/101-M microcomputer module in assembly language. Fee: £250. Contact: Mike Hughes, Microprocessor Training Centre, Texas Instruments Ltd, Manton Lane, Bedford MK1 7PA. Tel: (0234) 67466 Extn. 3718.
- **25** **Microelectronics and microcomputers.** Venue: Worcester College of Higher Education. Practical course dealing with electronic systems, particularly with regard to microcomputers. No previous knowledge of electronics or computing necessary. Fee: £39. Contact: B H Whalley, head of educational technology service, Worcester College of Higher Education, Henwick Grove, Worcester WR2 6AJ. Tel: (0905) 422131. Extn. 53.
- **30** **Practical introduction to microprocessors.** Venue: Cambridge. Covers the basics of microprocessors and how to use them, starting from first principles, with use of individual Nanocomputers. Fee: £50 + VAT — free if you buy a Nanocomputer. Contact: Course Registrar, Cambridge Microcomputer Ltd, Cambridge Science Park, Milton Road, Cambridge, CB4 4BN. Tel: (0223) 314666. □

Books

Beginners' guide to microprocessors and computing

by E F Scott, published by Bernard Babani (Publishing) Ltd.

Paperback, 121 pages, £1.75.
ISBN 0 900162 87 2

THE AUTHOR'S preface describes it as an introduction to the basic theory and concepts of binary arithmetic, microprocessor operation, and machine language programming for CSE and O level examinations, technicians, engineers and hobbyists. I cannot really recommend it for any of these purposes.

The book consists of three chapters, a glossary, an appendix describing some of the INTEL 8080 instruction set, and 12 questions and answers. There is no index. Chapter one describes binary arithmetic, Binary Coded Decimal, ASCII and the difference between serial and parallel data transfer. Chapter two describes basic microprocessor architecture and chapter three programming.

The hardware descriptions and machine-language programming examples are extremely basic and not very well explained, but they are, at least, accurate. The high-level language section is poor.

Conclusions

- A newcomer to computing,

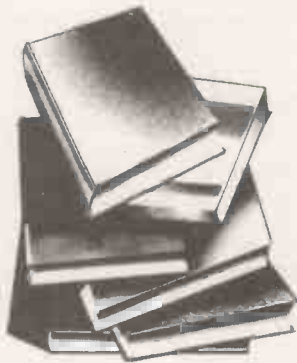

deserves a far better introduction than this.

A hitch-hiker's guide to the Pet

By C Preston. Petsoft 1979

A HITCH-HIKER'S guide to the Pet is a useful collection of software facts intended for those who want to do something a little out of the ordinary with their Pet. It should be of value to adventurous programmers in both Basic and assembler.

There are three sections. The first describes 21 useful memory locations and gives examples of the effects which can be achieved by inspecting and modifying them. The second describes 28 ROM subroutines and shows how they can be exploited.

The third section describes file handling on the Pet, showing how files can be read and written from assembler programs using ROM

subroutines. An appendix explains how memory is used by Basic and gives the token values for Basic keywords and symbols.

The hitch-hiker's guide is well-written and easy to use, although prospective purchasers should be warned that it only refers to Pets with the new ROMs — old ROMs are completely different in the subroutine addresses.

Conclusions

- If you want to extend your use of a new-ROM Pet, the book can be thoroughly recommended for its detailed explanations and its lucid and straightforward style.

Case studies in systems analysis

By J P A Race, published by Macmillan, 112 pages.
Paperback, £3.25
ISBN 0 333 23733 1.

SYSTEMS analysis is the study, design and implementation of computer-based systems. Typically the systems analyst's job may be to investigate the way a company performs part of its operation — order processing, stock control, sales-receipt analysis, fraud prevention — and to write a report describing in some detail a computer-based system which will meet the requirements.

The systems analyst must be able to absorb considerable

detail about a firm's commercial operations; to identify and understand the essential elements by reading reports and talking to key individuals; to conceive, design and cost a suitable computer system; and to present his ideas effectively.

Case studies in systems analysis is designed to develop those skills, by providing 10, detailed case studies which can be used in the second half of a course in systems analysis, with groups of students formed into syndicates to address the chosen case study and with active tutorial support from the course teacher.

For those purposes, the book is excellent, although the necessity of issuing all the material in a single volume means that the author's notes on the case studies cannot be concealed from the students, which is a pity.

It also has great strengths as a self-study text. Read quickly, from cover to cover, it provides a good insight into the nature of systems analysis and can be recommended to anyone thinking of training in the profession.

Conclusions

- If you think you may be interested in systems analysis, £3.25 is a small price to pay to find out. Recommended both for entertainment and for serious work.

Martyn Thomas □

A PRACTICAL GLOSSARY

Continuing the terminological gamut from T to W

TTY

Abbreviation for Teletype — and sometimes by extension for Teletypewriters in general.

Turnkey

A turnkey system is theoretically complete and ready to go — the user need only turn a key to start work. In practice, most small business systems are indeed started by a key, though some just have an on-off switch.

The essence of turnkey is that the user has minimal involvement in the protracted and technical process of designing, developing, testing and implementing the computer system which he or she will eventually use.

So the product sold to the customer should consist of a ready-programmed computer, complete with operating instructions and training as well as all relevant manuals. That is the way most computers are sold today — after all, you don't have to understand how a typewriter or a car works to use them.

In practice, it is rarely as simple as that. The user has to be sure that the all-in system on offer does in fact match all his requirements and that there will be no contractual problems when the software writers starts bickering with the hardware supplier. Still, it works reasonably well.

Two's complement

This is another esoteric idea; it's a method of expressing binary numbers where the negative of a number is generated by complementing the number and adding 1. The effect is such that you can then perform signed arithmetic with binary numbers.

UART

Universal Asynchronous Receiver/Transmitter. It is a serial-to-parallel and parallel-to-serial converter.

UNIBUS

A trademark of Digital Equipment, the top maker of mini-computers. The UNIBUS is the single high-speed bus in the PDP-11; it is a classic approach to mini-computer design, especially good because it really simplifies the connection of additional peripherals, more memory and upgraded processors.

Yet it has limitations — it is slightly complicated for micros, and the LSI-11 does not use the UNIBUS technique. That type of bus cannot cope with very complicated systems, so the larger Digital computers don't use it either.

Unit record

Normally means a thing which holds a whole record — the thing typically being a punched card or a ledger card.

A unit-record computer is a little-used term to refer to a visible-record computer, an out-dated type of business computer which stores its information on ledger cards.

Univac

Today it is Sperry Univac, part of the big Sperry group and one of the top four computer manufacturers in the world. The original UNIVAC was the world's first commercially-produced, stored-program computer, bought by the U.S. Bureau of the Census in 1951.

The word is an immodest acronym for UNIVersal Automatic Computer.

You may note that these days, few people are prepared to describe the average computer as really universal or fully automatic.

USART

The Universal Synchronous/Asynchronous Receiver/Transmitter is an improvement on the UART in that it may be programmed to operate as a synchronous communications link.

USASCII

More popularly known as ASCII, though one stands for U.S.A. Standard Code for Information Interchange and the other is the American Standard Code for Information Interchange.

Users' group

It is obvious that a users' group is a bunch of people who own computers from a particular supplier, or who have some other kind of computing interest. This entry is to emphasise how valuable that kind of association can be, even when it is a manufacturer-inspired mouthpiece designed primarily for marketing purposes.

Users can discuss problems, swap solutions and programs, band together to obtain discounts on bulk-buying consumables, like paper and discs, and if necessary present a coherent front to force some action from the supplier. Buy a computer which has a decent users' group; then join it and use it.

Utility programs

They are a collection of programs for routine tasks — some systems offer utility subroutines as well, helpful functions which can be called by a user program.

Value

It is a number assigned to a variable.

Variable

A symbolic unit which can take a variety of values. In practice, it is anything which can be altered, measured or controlled and which can, therefore, have different values at different times.

VDU

Visual — or sometimes video — display unit. It is a screen-plus-keyboard terminal.

Vector

An address given to the processor which will direct it to a new area of memory. A vectored interrupt is an interrupt which causes a transfer to a particular interrupt-handler routine starting at the location specified — rather than leaving things to some generalised interrupt routine.

Verification

Checking input data to make sure it was entered correctly.

Viewdata

The Post Office leads the world with Prestel — that is the trade name for its viewdata system. In fact the Post Office coined the name viewdata originally for its service, but international committees intervened and decreed that viewdata should be the generic term.

So it is the generic term for a centrally-run information retrieval service whereby subscribers with the appropriate equipment can dial the computer,

access particular pages of information on its database by using a numeric keypad, and obtain the information displayed on a modified TV set or a special terminal. Simple idea, but quite hard to implement.

One day, it will not be difficult to use screen-based personal computers as viewdata terminals. Then, maybe, we shall see a significant step towards the global village, an electronically-based, information-using society rather than merely an oil-based, energy-using one.

Virtual memory

This is a really clever operating systems technique whereby the programmer appears to gain a much larger memory space in which to work than is actually available.

What happens is that the operating system extends the possible addressing range to some or all of the disc-backing storage. It does this by transferring chunks of programs between disc and main memory automatically.

In theory, the program can address the whole address space without having to worry whether memory or disc is being referenced.

The problems are such that virtual memory is feasible only on reasonably large computers. The super-clever operating system needs a good deal of memory for a start, the disc transfers have to be quick and the processor itself must also be speedy.

Volatile

Non-retentive, usually applying to memory — MOS semiconductor memory loses its contents when you switch-off the power; that is its biggest problem. Core, is non-volatile, which means it retains its data. Some of the newer, and more expensive memory technologies are also non-volatile.

VLSI

Very Large Scale Integration. The next step up from LSI, usually taken to mean more than 10,000 circuits per chip.

Wafer

A lump of silicon is cut into thin slices on which semiconductor chips are fabricated. Those slices are also called wafers. 

Buy here at discount prices!

Save money.

☆ Full after-sales service in our own workshops ☆ One year guarantee on all machines

Leasing available to companies

Up to 1.6Mb for PET!

and 'on-line' with the Computhink Disc System

*Allows powerful business programmes using 16 Extra BASIC commands. *Easy to connect and use - plugs directly into 16/32K PETs, detailed manual supplied. *Simple startup (no difficult procedures to remember) as Disc Op. System in ROM. *Ready to run - useful programmes supplied free; full set of professionally written business packages available - Sales and Purchase Ledger, Stock Control, Payroll etc.. *Real-Time processing, Engineering and Commercial boundaries overcome with full language support - Business BASIC, ASSEMBLER, FORTRAN, COBOL, PASCAL, FORTH, FIFTH, PLM, PILOT & CESIL.

24K Memory expansion with dual disc for old ROM 8K PET £275 for new ROM 8K PET £320

Basic 400K dual disc system

only **£840**

800K £1,095
1.6 Mb £2,190

Credit terms available

The only 16k complete computer for under £400

Keyboard computer, power supply, UHF modulator and all cables to plug into your own TV set and cassette recorder and go!! 16K of user RAM for decent size programmes and data, sophisticated level II Microsoft BASIC. Complete with level I and level II programming manuals. What more could you ask?

TRS-80

£381⁷⁴

Expansion interface £199.09
4K level I computer £251.30

Now! Numeric keypad included

This must be today's best buy!

Get into print this easy way!

Fast!

Immaculate!

Low, low price!



Anadex DP 8000 dot-matrix printer

*Speedy 112 ch/s bidir. *Fits A4 page - up to 80 cols. *Up to 4 copies. *Precision form-filling with sprocket feed. *Special headings using double-width chars. *Modern paper format to match A4 filing systems. *Other paper sizes with adj. sprocket. *Full punctuation, U/L case, £ sign, 96-ch. set. *Reliable - strongly built, 100 M.ch. head.

Knock down price!

£499

Interfaces -
Pet £45 Ohios £10
TRS-80 £40 Sorcerer £8
Apple £45



IBM golfball printer ideal for word-processing

*Forget expensive Spin-Wheel printers - the Golfball produces equal quality at up to 15 ch. per sec. *Match various typewriter styles with IBM interchangeable heads. *Completely reliable - each machine rebuilt by IBM trained engineers and fully guaranteed. *Precision form-filling possible with 15 in. pin-feed platen.

Limited supply!

£595

Interfaces -
Pet £45 Ohios £10
TRS-80 £35 Sorcerer £8
Apple £45



Quick Printer II

*Now at remarkable price, a high-quality 'tally-roll' printer to list programmes. *OK in offices or after midnight, printout is a quiet 'z-z-z'. *Uses now-cheap, 6 cm wide aluminised paper (£1.74 roll), convenient for listings, perfect for photocopying. *Fast! - 120 lines/min. *32 cols. Software selected double-width chs. *96 chs. incl. lower case. *No extra for TRS-80 bus interface.

£147⁸⁰

Interfaces -
Pet £45 Apple £45
Ohios/Sorcerer/UK101 £10
TRS-80 Exp. I/F £11.26

PET 2001-8N (8K RAM New large keyboard)

£469

2001 - 16N (16K RAM and new large keyboard) £590
2001 - 32N (32K RAM and new large keyboard) £890
External cassette deck, suitable for all Pets £53
CBM dual drive mini floppy £745
Tractor feed printer with Pet graphics £499
Pet high-res. graphics 200 x 320 £259

You can afford to start computing now! - with the Ohio CI-P

As imported, fully tested, complete with 4K RAM, but unconverted to UK std. (conversion instructions supplied).

£199

Add £24 for converted model. Extra 4K RAM £39.

*Powerful programming possible - 6502 processor, fast 8K Microsoft floating-point BASIC (easy to learn). Superior utilities, 53 key key-board, giving upper and lower case, user-definable keys, gaming and graphics chs. Ultra-fast and powerful machine code from keyboard. *No intricate soldering or metal work. Computer supplied assembled in ready-made case. *Reasonable sized programmes in 4K RAM. *Expandable to 24K RAM in case, drives discs, printer; available items include Assembler/Editor and Extended Monitor. *Programme interchangeability/reliability - Kansas City tape interface. *Save programmes on own cassette recorder - all cables supplied.

- at a lower price than equivalent kits!

COMPUTERAMA

Your dealer for Bath, Bristol and S.W.

Tel: Bath (0225) 28819

We stock components, test instruments, tools etc.

LTD.

TANDY DEALER

VISA

AMERICAN EXPRESS

master charge

BARCLAYCARD VISA

Computerama Ltd.
Harpers Kensington Showrooms
London Rd. Bath, Avon

Credit card orders accepted by telephone for immediate despatch.

Loads of software - ask for list!

Please add £10 Securicor delivery on computers etc. plus 15% VAT on all prices

PC/A

interface components

nascom-2



£225 + VAT + P&P
£1.50

nascom-1

12" x 8" PCB carrying 5LSI MOS packages, 16 1K MOS memory packages and 33 TTL packages. There is on-board interface for UHF or unmodulated video and cassette or teletype. The 4K memory block is assigned to the operating system.

video display and EPROM option socket, leaving a 1K user RAM. The MPU is the standard Z80 which is capable of executing 158 instructions including all 8080 code. **Built price £140 + VAT.**

£125 + VAT + P&P
£1.50

MEMORY ● 8K Microsoft BASIC ● 2K NAS-SYS 1 monitor ● 1K Video RAM ● 1K Workspace/User RAM. ● On-board 8 sockets provided for memory expansion using standard 24-pin devices: 2708, 2716, 2732 EPROMS and MK4118 static RAM. **MICROPROCESSOR** ● Z80A which will run at 4MHz but is selectable between 2/4 MHz. **HARDWARE** ● Industrial standard 12" x 8" PCB, through hole plated, masked and screen printed. All bus lines are fully buffered on-board. **INTERFACES** ● Licon 57 key solid state keyboard ● Monitor/domestic TV interface ● Kansas City cassette interface (300/1200 baud) or RS232/20mA teletype interface. The Nascom 2 kit is supplied complete with construction article and extensive software manual for the monitor and BASIC.

REVOLUTIONARY TOUCH ACTIVATED KEYBOARD TASA MODEL 55



£49.50 + VAT + P&P
£1.50

Designed and manufactured by TASA Inc of California, the TASA keyboard is a truly solid state system that has no moving parts and is virtually indestructible. Totally flat and measuring just 0.325" thick, 6.25" deep, 15.05" wide, the TASA has full 128 position 8-bit ASCII output plus continuous strobe, parity select. The touch sensors are sealed in tough polycarbonate which is washable and can withstand rugged treatment in harsh environments.

- Other features include:
- Built-in electronic shift lock.
 - Two-key rollover to prevent accidental two-key operation (excluding "control" and "shift").
 - Electronic hysteresis for firm "feel".
 - Signal activation time of 1 millisecond.
 - Output via 12-way edge connector.
 - CMOS compatible with pull-up resistor.
 - Parallel output: active pull-down, direct TTL compatible (one load) open collector type.

NEW

THE MOST FLEXIBLE SYSTEM EVER!

Nascom System 80 – Total Option Concept



Floppy disc system
Double sided double density 5 1/4 in disc giving 280K bytes formatted, including controller board/PSU/Housing and interconnects £480. Controller board £127.50 • Second Disc £240 CP/M £80



System 80 housing
High strength GRP moulding in variety of colours. Accepts 12x8 Nascom 2 CPU board, four 8x8 expansion boards, £85 incl. frame racking, interconnects and mother board.
Expansion boards*
16K RAM £140.00 • 32K RAM £200.00

High Resolution Programmable Graphics £90 (KIT)
High Resolution Colour board £140 (KIT)

*Available in kit form
All prices subject to VAT.

NEW

AVAILABLE SOON

Microprocessor board (Nascom 2)
4MHz Z80 CPU, TV or Video • 1200 baud Kansas City • Serial RS 232 printer
Interfaces: Keyboard, 128 character ASCII plus 128 Graphics in 2 x 2K ROM, free 16-way parallel port, 8K BASIC, NAS SYS operating monitor £280 built and tested
Firmware & MOS ICs
Zeap Assembler (4 1Kx8 EPROMS) £50
NAS Pen text editor (2 1Kx8 EPROMS) £30
NAS-DIS disassembler (3 1Kx8 EPROMS) £37.50 • 2708 £9.50 • 2716 £26
MK 4118N4 £12.75 • MK 4116N4 £55 for 8

NASCOM FIRMWARE IN EPROM
NASPEN: £25.00 + VAT + 30p P + P
ZEAP 2: £50.00 + VAT + 30p P + P
NAS-SYS 1: £25.00 + VAT + 30p P + P

NASCOM SOFTWARE ON TAPE
8K BASIC: £15.00 + VAT
ZEAP 1: £30.00 + VAT + 50p P + P
ZEAP 2: £30.00 + VAT + 50p P + P

NASCOM HARDWARE
Motherboard: £5.50 + VAT + 50p P + P
Mini Motherboard: £2.90 + VAT + 50p P + P

3 amp PSU: £29.50 + VAT + £1.50 P + P
VERO DIP board: £10.50 + VAT + 50p P + P
FRAME: £32.50 + VAT + £2.00 P + P

NASCOM IMP PLAIN PAPER PRINTER



£325 + VAT + P&P
£2.95

The Nascom IMP (Impact Matrix Printer) features :

- 60 lines per minute ● 80 characters per line ● Bi-directional printing ● 10 line print buffer ● Automatic CR/LF ● 96 characters ASCII set (includes upper/lower case, \$, #, £)
- Accepts 8 1/2" paper (pressure feed) ● Accepts 9 1/2" paper (tractor feed) ● Tractor/pressure feed ● Baud rate from 110 to 9600
- External signal for optional synchronisation of baud rate ● Serial RS232 interface.

MICRO MART

IC SOCKETS	
8 pin	10p each
14 pin	12p each
16 pin	13p each
20 pin	25p each
24 pin	30p each
28 pin	35p each
40 pin	40p each
ICs	
EPROMs 2708	£9.00 each
EPROMs 2716	£26.00 each
MEMORIES	
21L02	£0.80 each
4027	£2.75 each
4116	£7.50 each
2114	£4.00 each
Z80 DEVICES	
MK3880	£12.50 each
MK3881 (P10)	£7.50 each
MK3882 (CTC)	£7.50 each
VOLTAGE REGULATOR	
SPECIAL OFFER	
LM309K	90p each
Add VAT and 30p P&P to all orders	

VISIT OUR NEW SHOP
We stock PET, TRS80, Sharp MZ-80K, Atari TV games and extensive range of electronic components including ICs, discrete semiconductors, capacitors, resistors, VERO products, tools and accessories for both professional and amateur constructors.

ORDER FORM

Send your orders to: PC/7/80
Interface Components Ltd, Oakfield Corner,
Sycamore Road, Amersham, Bucks HP6 6SU.
Tel: 02403 22307. Telex: 837788.

Description	Quantity	Price
+ VAT at 15%		
+ P + P		
Total enclosed		

Please allow 28 days for Postal Delivery

Name _____
Address _____
Access/Barclaycard No: _____
*Cheques & P/Os made payable to Interface Components Ltd.

CHESTER COMPUTING CENTRE S.100

Desk top mainframe with power supplies, motherboard and fan

As above, cut-out for 5 1/4" drives £239

As above, cut-out for 8" drives £284

As above, cut-out for 8" drives £346

BOARDS

	KIT	A & T
Z80 CPU board, 2MHz, Ithaca	£99	£139
CB2, Z80A CPU, IEEE S100	£112	£146
SBC100, Z80 + Serial + Parallel ports	£155	£210
SBC200, as above, 4MHz	£182	£242
8K static RAM 4MHz, Econoram 2	£84	£100
16K static RAM 4MHz, Econoram 4	£145	£178
32K static RAM 4MHz, Econoram X	£302	£349
64K Dynamic, Expandoram I 64K, 2MHz	£400	£489
104 2 Serial, 2 Parallel	£89	£129
VDB - 8024 (80 char x 24 line) Video	£194	£263
VB1 (64 char x 16 line) Video	£90	£135
VB3 (80 char x 24 line) Video, IEEE	£220	£255
PB1 PROM Programmer 2708/2716	£84	£122
Tarbell disc controller, single density	£132	£188
Tarbell disc controller, double density	£188	£244
Versafloppy disc controller, single density	£135	£190
DRI 7100 8" Drive (single-sided)		£350
DRI 7200 8" Drive (double-sided)		£450
SA400 5 1/4" Drive (single-sided)		£189
Extender Board		£25
Prototyping Board		£15

Complete systems to order.

Wide range of software and many other boards available. Carriage extra. All prices exclude VAT at 15%. C.W.O. only. Write or phone:

**Chester Computing Centre,
21-23 Charles Street, Hoole,
Chester CH2 3AY.
Tel: Chester (0422) 21817**

•Circle No. 309

data tablet digitizer

Summagraphics ID

The latest advancement in the sphere of data input through a tablet digitizer has a flexibility that gives it a wide application in technical, industrial and scientific projects. The 'ID' (intelligent digitizer) has a built-in microprocessor which implements important features such as a relocatable origin, incremental mode, output data formatting and many other valuable advantages inherent in the Summagraphics 'ID'.

Write, phone or complete coupon for full information.



Terminal Display Systems Ltd

Hillside, Whitebirk Estate,
Blackburn, Lancs. BB1 5BR
Telephone (0254) 662244
Telex 63162 TDS G

More information please on the data tablet digitizer.
Send to Terminal Display Systems Ltd., Hillside, Whitebirk Estate, Blackburn, Lancs. BB1 5BR.

Name _____
Address _____



•Circle No. 310

Advertisement Index

A		Dillon's University Bookshop	146	L		Research Resources	22
ACT Petsoft	76, 77, 97	Discon	176	LB Electronics	166	Rostronics	145
AJD Direct Supplies	24	Dyad Developments	32	Leenshire	178	Route 66	172
A J Harding (Molimerx)	13			Lifboat Associates	182-183		
AJR		E		Lionhouse Micros	64	S	
Almarc	25	Educational Computing	159	Little Genius	16	SGS-Ates	10, 11
Amazing Games	115	EGA	26	Liveport	70	Sharp Electronics	94
AM Taskforce	148	EMG	148	L & J Computers	115	Sheffield Computer Centre	88, 155
Audiogenic	85	Encotel	175	Logitek	144	Sigma U.K.	165
		Equinox	57, 103	London Computer Store	37	Simon Computing	158
		Essex Computer Services	166	LP Enterprises	29	Sintrom Microshop	4
B						Sirton Products	157
Beaver Systems	170	F		M		Slough Microshop	16
BNR & ES	152	Farmplan	38	Media 5	24	Small Systems Engineering	158
Business Computer Services	30	Fortronic	120	Microbits	6, 7	Southern Software	150
Business & Leisure Micros	20			Micro Business Centre	158	Stack	19
Buss Stop	164	G		Microbyte	169	Stage One Computers	149
Butel Comco	43	Games Workshop	18	Microcentre	2	Strutt	120
Byte Shop Computerland	15, 176	Gate Microsystems	36	Microcomputer Applications	38	Systematics International	75
Bytronix	85	Gemsoft	160	Micro Control	121		
		GP Industrial Electronics	34	Microdata	160	T	
C		Graffcom	168	Micro Facilities	150	Tandberg	177
Caddis Computer Systems	164	Gramma Winter	8 & 9	Micro Management	20	Tandy Computers	181
Calco Software	148	Guestel	156	Micropute	170	Tangerine	142
Cambridge Computer Store	51			Microsense	106	Telefusion	31
Camden Electronics	34	H		Microsolve	39	Telesystems	14
Chester Computing Centre	189	Hal Computers	156, 172	Microtek	28	Terminal Display	189
Chromasonic	16	Happy Memories	20	Microtrend	72	Terminals Systems	152
Clenio Computing	14, 154	HB Computers	78	Microware	30	Terodec	23
Colin Bentley Associates	168	Henry's Radio	167	Mighty Micro	18	The Computer Bookshop	112
Comart	5, 111	Hewart	178	Mike Rose Micros	174	The Computer Shop	166
Commodore	45, 49, 53	Hi-tech Electronics	162	Mlnister Micros	146	The Software House	108
Comp Shop	190, 191	HSV	115	Mutek	178	Total Concept Systems	30
Computastore	101			N		Transam	21
Computech	179	I		Newbear	161	Tridata Micros	56
Computarama	187	Icarus	35	NIC	32	T & V Johnson	122-123
Computerbits	163	Image Data	82	Northern Software Consultants	118	Tycho Business Systems	174
Computerland	32	Informex Centralex	22	O		V	
Computopia	152	Intelligent Artefacts	150	Online	116	V & T Electronics	26
Control Dataset	28	Interface Components	188	Optelco	12	Video Vector Dynamics	162
CRA		Intex Datalog	172			Vlasak	153
Cream Microshop	12	Ithaca Intersystems	192	P		Volker-Craig	140
Creamwood Associates	146			Padmede	98	W	
Crofton Electronics	164	J		Personal Computers	141, 176	Willis Computer Supplies	156
Crystal Electronics	168	JPS	170	Petalect	171		
Cumana	173	K		Petsoft	97	X	
		Katanna	27	Printout	67	X-Data	147
D		Keen Computers	99	Pyral Magnetics	120	Xitan	144
Datalink	180	KGM	151	R		Z	
Dataplus	154	Kingston Computers	17	Rair	100	Zero 1	14
Datron Microcentre	36	Kode	160	Research Machines	33		
David Richards	174						
Davinci	24						
Digitus	40						

8MHz Super Quality Modulators	£4.90
6MHz Standard Modulators	£2.90
C12 Computer Grade Cassettes 10 for	£4.00
Super Multi-rail P.S.U. +5 -5 +12v	£29.50
ETI Breakout Game - Chip and PCB	£9.90
S100 Expansion Motherboard for Nascom I	£39.00
Anadex Printer Paper - 2000 sheets	£25.00
Floppy Disks 5¼" Hard & Soft Sectored	£3.50
Floppy Disk Library Case 5¼"	£3.50
Eprom Boards	£63.00
8K Static Ram Boards - S100	£110.00
Cartridges for Grandstand	£11.99
George Risk Ascii Keyboard	£39.00
Cartridges for Atari - Full Range in Stock	£13.90
Interface PET IEEE - Centronics Parallel Not decoded	£49.00
Decoded	£77.00
Interface to Centronics parallel for TRS80	£75.00
Verocases for Nascom 1 & 2 etc.	£22.50
Keyboard Cases	£9.90
Electric Pencil for TRS80	£29.00

SPECIAL SCOOP

GET YOURSELF A PRINTER FOR YOUR PET AND SAVE A FORTUNE

only **£399 + VAT**

Full Pet Graphics including cables. Ready to go.

EX-STOCK.



HITACHI PROFESSIONAL MONITORS

9" - **£129**
12" - **£199**

- Reliability Solid state circuitry using an IC and silicon transistors ensures high reliability.
- 500 lines horizontal resolution Horizontal resolution in excess of 500 lines is achieved in picture center.
- Stable picture Even played back pictures of VTR can be displayed without jittering.
- Looping video input Video input can be looped through with built-in termination switch.
- External sync operation (available as option for U and C types)
- Compact construction Two monitors are mountable side by side in a standard 19-inch rack.



A PROFESSIONAL WORD PROCESSING SYSTEM AND IT'S A COMPUTER AS WELL.

ALL FOR ONLY £3250 + VAT including Word Pro and Cables.

£790 + VAT

£1750 + VAT RRP £2200



PET 32K - This is the standard 32K Pet from Commodore. Reverse video and graphics allow the WordPro Package to give simple clear and easy to read displays.

2040 Disk Drives Twin disk drives allow large high speed storage for your letters, or paragraphs. Plugs in the back of the PET.

NEC Spinwriter NEC's high quality printer uses a print "thimble" that has less diameter and inertia than a daisy wheel, giving a quieter, faster, more reliable printer that can cope with plotting and printing (128 ASCII characters) with up to five copies, friction or tractor fed. The ribbon and thimble can be changed in seconds. 55 characters per second bidirectional printing - with red/black, bold, subscript, superscript, proportional spacing, tabbing, and much, much more.

WordPro II The heart of the system - consists of a ROM and diskette. The ROM is inserted into a space socket inside the Pet. One of the most versatile Word Processing Packages around.

All items sold separately.

only **£356 + VAT**

TRS80 LEVEL 2 16K

Fully converted to UK T.V. Standard Comes complete with easy to follow manuals, UK Power Supply - Cassette Leads - Sample tapes. Special box to enable you to plug into your own TV. Recommended for first time buyers. Just plug in and go. Full Range of Software Available

Model with numeric key pad £389 + VAT
4K Level I - machine only £251 + VAT



NEW REDUCED PRICES

8K **£449** + VAT
16K **£549** + VAT
32K **£649** + VAT

The PEDIGREE PETS

RRP £795 for 32K

Very popular for home & business use. 8K Microsoft Basic in ROM. 8K Pet 32K & 16K with new improved keyboard. All with green screen.

Extra cassette deck **£55** Full range of software available.



32K **£690 + VAT**
48K **£790 + VAT**

EXIDY SORCERER

RRP £859 for 32K

For Personal or Business Use. 32K or 48K memory. 8K Microsoft Basic in ROM. Dual Cassette I/O, RS232 I/O. Parallel I/O (Centronics). Expansion available through optional extra S100 Motherboard. 69 Key keyboard including 16 key numeric pad.

S100 EXPANSION - £199



NASCOM IMP PLAIN PAPER PRINTER

fully built and housed in a stylish enclosure for just **£325** plus VAT. Interfaces with all micro computers.

The Nascom IMP (Impact Matrix Printer) features are listed below:

- 60 lines per minute.
- 80 characters per line.
- Bi-directional printing.
- 10 line print buffer.
- Automatic CR/LF.
- 96 character ASCII set (including upper/lower case, \$, #, ., !).
- Accepts 8½" paper (pressure feed).
- Accepts 9½" paper (tractor feed).
- Tractor/pressure feed.
- Baud rate from 110 to 9600.
- External signal for optional synchronisation of baud rate.
- Serial RS232 interface with parallel option available soon.

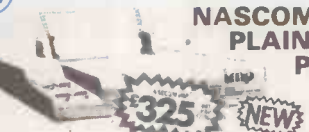

only **£295 + VAT**

TRS80 EXPANSION INTERFACE

Expand your TRS80 by 32K. 32K Memory on board Centronics parallel port. Disk controller card. Real time clock. Requires Level II Basic. Interface for 2 cassette decks. complete with power supply.



RRP **£540** only **£499 + VAT**

ANADIX DP8000

Super Quality - Low cost printer. Tractor Feed with full 96 ASCII character set. Accepts RS232C at band rates between 100 and 9600 and Parallel Bit data. Attaches either directly or through interfaces to Pet, Apple, TRS80, Sorcerer, Nascom, CompuKit etc.



video 100

12" BLACK & WHITE LOW COST VIDEO MONITOR

RRP £79

only **£69 + VAT**

- Ideal for home, personal and business computer systems
- 12" diagonal video-monitor
- Composite video input
- Composite video input
- Compatible with many computer systems
- Solid-state circuitry for a stable & sharp picture
- Video bandwidth - 12MHz + 3DB
- Input impedance - 75 Ohms
- Resolution - 650 lines Minimum In Central 80% of CRT; 550 Lines Minimum beyond central 80%.



NASCOM-2 MICRO-COMPUTER

only **£295 + VAT**

Your choice of freebies with every Nascom 2 purchased from us

either FREE POWER SUPPLY OR FREE GRAPHICS ROM OR FREE VERO CASE TO TAKE NASCOM 2

Microprocessors 280A, 8 bit CPU. This will run at 4MHz but is selectable between 1/2/4 Mhz. This CPU has now been generally accepted as the most powerful, 8 bit processor on the market.

INTERFACE

Keyboard New expanded 57 key Licon solid state keyboard especially built for Nascom. Uses standard Nascom, monitor controlled, decoding.

T.V. The lv peak to peak video signal can drive a monitor directly and is also fed to the on-board modulator to drive the domestic T.V.

I.O. On-board UART (Int.6402) which provides serial handling for the on-board cassette interface or the RS232/20mA teletype interface. The cassette interface is Kansas City standard at either 300 or 1200 baud. This is a link option on the NASCOM-2. The RS232 and 20mA loop connector will interface directly into any standard teletype.

The input and output sides of the UART are independently switchable between any of the options - i.e. it is possible to house input on the cassette and output on the printer.

PIO There is also a totally uncommitted Parallel I/O (MK3881) giving 16, programmable, I/O lines. These are addressable as 2 x 8 bit ports with complete handshake controls.

Documentation Full construction article is provided for those who buy a kit and an extensive software manual is provided for the monitor and Basic.

Basic The Nascom 2 contains a full 8K Microsoft Basic in one ROM chip with additional features like DEEK, DOKE, SET, RESET for simple programming.

With free 16K RAM board.



COMPUKIT UK101

EUROPE'S FASTEST SELLING ONE BOARD COMPUTER



- ★ 6502 based system — best value for money on the market.
- ★ Powerful 8K Basic — Fastest around
- ★ Full Qwerty Keyboard
- ★ 4K RAM Expandable to 8K on board.
- ★ Power supply and RF Modulator on board.
- ★ No Extras needed — Plug-in and go.
- ★ Kansas City Tape Interface on board.
- ★ Free Sampler Tape including powerful Dissassembler and Monitor with each Kit.
- ★ If you want to learn about Micros, but didn't know which machine to buy then **this is the machine for you.**

Build, Understand and Program your own Computer for only a small outlay.

KIT ONLY **£199 + VAT**
NO EXTRAS NEEDED

AVAILABLE READY ASSEMBLED & TESTED
READY TO GO FOR **£249 + VAT**

Specialty designed case for CompuKit in orange/black. With room for accessories. **£29.50 + VAT**

6502 Assembler/Editor for CompuKit **£14.90 + VAT**

The **CompuKit UK101** comes in kit form with all the parts necessary to be up and working, supplied. No extras are needed. After plugging in just press the reset keys and the whole world of computing is at your fingertips. Should you wish to work in the machine code of the 6502 then just press the M key and the machine will be ready to execute your commands and programs. By pressing the C key the world of Basic is open to you.

This machine is ideal to the computing student or Maths student, ideal to teach your children arithmetic, and is also great fun to use.

Because of the enormous volume of users of this kit we are able to offer a new reduced price of **£199 + VAT**

NEW MONITOR FOR COMPUKIT UK101 ● In 2K Eprom 2716
● Allows screen editing ● Saves data on tape
● Flashing cursor ● Text scrolls down **£22.00 + VAT**

THE NEW TRS80 SURPRISE — MODEL II

Fast and expandable
Model II operates at twice TRS-80's high speed.



In addition to either 32 or 64 thousand characters (bytes) of internal Random Access Memory, one built-in 8" floppy disk stores an additional one-half million bytes, including the Disk Operating System. And you can easily expand up to a four-disk system for up to two-million bytes of storage.

Model II features upper and lower case letters. Its built-in 12" high-resolution video monitor displays 24 lines of 80 normal characters. The professional 76-key keyboard (with "calculator" keypad) includes advanced functions such as Control, Escape, Caps, Hold, Repeat. The keyboard is detachable and moveable for convenient data entry.

You get the enhanced Level III version of TRS-80's already-famous Level II BASIC language and "TRSDOS" operating system, automatically loaded in memory when you "power up." (About 24K of RAM is used by this software.)

Each time you power up, Model II thoroughly tests itself to insure proper operation. Your chosen program can appear immediately, without any intermediate steps or questions to answer.

Versatility ... plug-in expandability

Built-in input/output capabilities include two RS-232C channels, and one Centronics parallel port. Future expansion is provided for through four plug-in slots for optional PC boards.

64K 1-Disk Model II **£2250.00 + VAT**

1 DISK EXPANSION Room for 3

500K per Drive gives total of 1.5M Byte — 1 Drive plus Cabinet **£799 + VAT**

Just Plug In

WE ARE NOW EX-STOCK



Why do people buy more from COMPSHOP than anywhere else?

- ★ **LARGER STOCKS** — we hardly ever run out
- ★ **GOOD SERVICE** — we give extended warranties on all our products.
- ★ **EXCELLENT REPAIR SERVICE** — Through Compcare we repair and maintain most makes of personal computers.

LAST YEAR WE SUPPLIED TO THE PUBLIC — LARGE & SMALL
16,000 Television Games & 7,000 Computer Systems

NEW TV GAME BREAK OUT

Has got to be one of the world's greatest TV games. You really get hooked. As featured in ETI. Has also 4 other pinball games and lots of options. Good kit for up-grading old amusement games.

MINI KIT — PCB, sound & vision modulator, memory chip and de-code chip. Very simple to construct. **£14.90 + VAT**
OR PCB £2.90 MAIN LSI £8.50 Both plus VAT



THE ATARI VIDEO COMPUTER SYSTEM

£99.00 + VAT



Atari's Video Computer System now offers more than 1300 different game variations and options in twenty great Game Program™ cartridges!

Have fun while you sharpen your mental and physical coordination. You can play rousing, challenging, sophisticated video games, the games that made Atari famous.

You'll have thrill after thrill, whether you're in the thick of a dogfight, screeching around a racetrack, or dodging asteroids in an alien galaxy. With crisp bright colour (on colour TV) and incredible, true-to-life sound effects. With special circuits to protect your TV.

Cartridges now available All at £13.90 each + VAT

Basic Maths, Airsea Battle, Black Jack, Breakout, Surround, Spacewar, Video Olympics, Outlaw, Basketball, Hunt & Score*, Space War, Sky Diver, Air Sea Battle Codebreaker*, Miniature Golf.

Extra Paddle Controllers
— **£14.90 + VAT**

*Keyboard Controllers
— **£16.90 + VAT**



"Europe's Largest Discount Personal Computer Store"

Please add VAT to all prices — Delivery at cost, will be advised at time of purchase. Please make cheques and postal orders payable to COMPSHOP LTD., or phone your order quoting BARCLAYCARD, ACCESS, DINERS CLUB or AMERICAN EXPRESS number.
CREDIT FACILITIES ARRANGED — send S.A.E. for application form.

14 Station Road, New Barnet, Hertfordshire, EN5 1QW Telex: 298755 TELCOM G

Telephone: 01-441 2922 (Sales) 01-449 6596

OPEN · 10 am - 7 pm — Monday to Saturday

Close to New Barnet BR Station — Moorgate Line.

★ NOW in IRELAND at: 80 Marlborough St., Dublin 1. Tel: Dublin 749933



COMP COMPUTER COMPONENTS

(Part of the Compsop Ltd. Group)



At Intersystems, "dump" is an instruction.

Not a way of life.

(Or, when you're ready for IEEE S-100, will your computer be ready for you?)



We're about to be gafflies again.

While everyone's been busy trying to convince you that large buses housed in strong metal boxes will guarantee versatility and ward off obsolescence, we've been busy with something better. Solving the *real* problem with the first line of computer products *built from the ground up to conform to the new IEEE S-100 Bus Standard*. Offering you extra versatility in 8-bit applications today. And a full 16 bits tomorrow.

We call our new line Series II™. And even if you don't need the full 24-bit address for up to 16 megabytes (!) of memory right now, they're something to think about. Because of all the perform-

ance, flexibility and economy they offer. Whether you're looking at a new mainframe, expanding your present one or upgrading your system with an eye to the future. (Series II boards are compatible with most existing S-100 systems and *all* IEEE S-100 Standard cards as other manufacturers get around to building them.)

Consider some of the features: Reliable operation to 4MHz and beyond. Full compatibility with 8- and 16-bit CPUs, peripherals and other devices. *Eight* levels of prioritized interrupts. Up to 16 individually-addressable DMA devices, with IEEE Standard overlapped operation. User-selectable functions addressed by DIP-switch or jumpers, eliminating soldering. And that's just for openers.

The best part is that all this heady stuff is available *now!* In our advanced processor—a full IEEE Bus Master featuring Memory Map™ addressing to a full megabyte. Our fast, flexible 16K Static RAM and 64K Dynamic RAM boards. An incredibly versatile and

economical 2-serial, 4-parallel Multiple I/O board. 8-bit A/D-D/A converter. Our Double-Density High-Speed Disk Controller. And what is undoubtedly the most flexible front panel in the business. Everything you need for a complete IEEE S-100 system. Available separately, or all together in our new DPS-1 Mainframe!

Whatever your needs, why dump your money into obsolete products labelled "IEEE timing compatible" or other words people use to make up for a lack of product. See the future now, at your Intersystems dealer or call/write for our new catalog. We'll tell you all about Series II and the new IEEE S-100 Bus we helped pioneer. Because it doesn't make sense to buy yesterday's products when tomorrow's are already here.

InterSystems™

Ithaca Intersystems,
58 Crouch Hall Road,
London, N8 8HG. U.K.
Telephone: 01-341-2447/Telex: 299568

